



REGO-FIX 

REGO-FIX▲



REGO-FIX▲

High-performance toolholding from the inventor of the ER collet

Founded in 1950, REGO-FIX is an internationally active family business with over 280 employees. REGO-FIX, located in Tenniken in the Basel region of Switzerland, has been producing and selling high-precision tool clamping systems for over 70 years.

The company has sales partners in 50 countries and subsidiaries in the USA, China, Brazil and Southeast Asia. The products are successfully implemented in the automotive, aerospace, mold and die, machine tool, medical, telecommunications and watchmaking industries.

A Swiss success story Its long-term business success is based on promoting employees and enabling them to shape the future together in a fast-paced environment. REGO-FIX has

a great mutual respect and maintains cross-cultural cooperation with the aim of developing innovative toolholding solutions together. Ongoing investments in research and development also lead to constantly new products and ensure a competitive product range. The trademark with the "triangle" is steadily gaining worldwide recognition: Today it is known throughout the industry and stands as a quality label for reliable and innovative products made in Switzerland!



Products that convince REGO-FIX unites four different toolholding systems: the ER System, nowadays established worldwide as an industry standard according to DIN 6499, is considered to be the original from the inventor. The micRun® MR system is a trend-setting further development of the successful ER System. Thanks to a guaranteed overall system concentricity of $\leq 3\mu\text{m}$ at $3\times D$, it is the perfect solution for all high-performance applications. The third system known as powRgrip® offers excellent concentricity, high vibration dampening and simple and safe handling. The Multi Line identifies itself as reliable tooling solutions for traditional machining. The common goal of the four systems is to optimize the machining process and to tailor the specific strengths to the individual requirements of modern machining.

Sustainable and successful Focused on the future and successful in the long term: REGO-FIX's sustainability strategy is based on a permanent focus on economic, ecological and social aspects. It represents the driver for sustainable corporate development and effectively promotes the corporate vision.



Driving innovations for 70 years Since 1950, we turn innovative thoughts into revolutionary products.



Standing together makes us stronger We manufacture products we can be proud of. Together we aim for excellence in every step we take: from the inspiring idea to the finished product.



Supreme Swiss quality standard Our products marked Swiss made are designed and manufactured at our headquarters in Tenniken, Switzerland.

Your application is our motivation

Rediscover modern machining Experience high-performance machining thanks to powRgrip®'s excellent runout, high vibration dampening and easy as well as secure handling. Enjoy the advantages for high speeds, difficult-to-handle work materials and generally demanding applications.



The logical evolution A grooveless clamping nut for optimal vibration and a total system runout of $\leq 3\mu\text{m}$ at 3xD offer incomparable precision in a collet-based system. The inventor reinvents the ER collet.



The original from the inventor When REGO-FIX first introduced the ER System in 1972, it took the machining world by storm. With the DIN 6499 standardization twenty years later, the REGO-FIX ER collet became the industry standard. Today, the ER System is still the most used toolholding system.



Tradition is a matter of class The outstanding product design paired with our experienced engineering offer a wide program of toolholders for traditional machining applications. No compromise for highest quality needs.



Table of contents

powRgrip® System

powRgrip® Clamping units	6
powRgrip® Toolholder	11
powRgrip® Collets	49

ER System

ER Toolholder	67
ER Collets	133
ER Clamping nuts	159

micRun® System

micRun® Toolholder	185
micRun® Collets	199
micRun® Clamping nuts	203

Multi Line System

Holders	207
Reduction sleeves	233

Accessories

Overview	237
----------	-----

Technical information

Overview	267
----------	-----



Experience the extensive powRgrip® offering

Clamping units

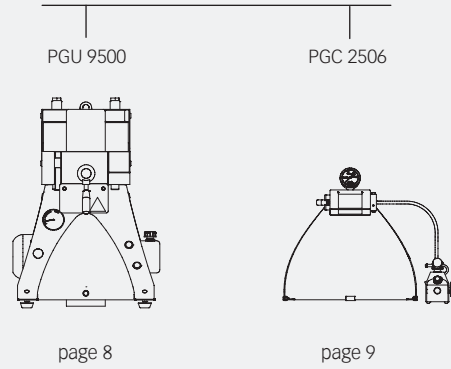

PGU 9500

PGC 2506

page 8

page 9

Standard

HSK/
PG

SK/
PG

BT/
PG

CAT/
PG

CAPTO/
PG

ISO 20/
PG

Cylindrical collet holders

CYL/
PG

Pullout protection secuRgrip®

PG-SG

Collet holders for tapping

HSK-A
SSY

CYL SSY
CYL GSF

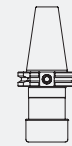
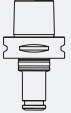
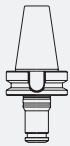
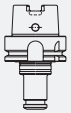

page 12

page 18

page 24

page 32

page 36

page 39

page 40

page 42

page 46

page 46

Micro machining

PG-MB



page 50

Standard

PG



page 51

Cooling

PG-CF



page 54

Long shanks

PG-L



page 57

Short shanks

PG-S



page 58

Turning collets

PG-T



page 60

Pullout protection secuRgrip®

PG-SG



page 61

Collets for tapping

PG-TAP



page 62

Concentricity and optimum vibration dampening saves time and money

Ambitious toolholding Thanks to the unique clamping method of PGU, the clamped tools can be used in production quickly and safely. The advanced technology not only increases the work safety for the user, but also reflects our ecological thinking, which manifests itself – among other things – through low energy consumption during the clamping process. The clamping unit clamps the powRgrip® collet into the toolholder with a force of up to 90 kN.

The pressure fit provided between the collet and toolholder creates a radial force, which is concentrated on the tool shank via the slotted collet and holds the tool safely and with a high degree of concentricity.

The powRgrip® System consists of

- // High-precision powRgrip® collet
- // powRgrip® toolholder
- // powRgrip® clamping unit (automatic or manual)

How the powRgrip® System works

- // Insert the cutting tool into the powRgrip® collet
- // Insert the powRgrip® collet into the powRgrip® toolholder
- // Clamp collet and cutting tool into the powRgrip® toolholder with a powRgrip® clamping unit PGU (automatic) or PGC (manual)



Cutting tool



powRgrip® collet



powRgrip® toolholder

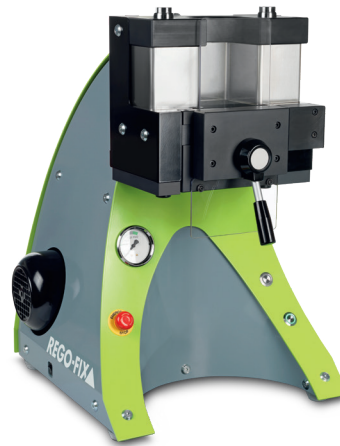

Automatic clamping unit PGU



Manual clamping unit PGC

Toolholding made fast, safe and easy

The clamping unit PGU 9500 has been awarded the Red Dot design award for industrial design, highlighting the good usability and outstanding design of the machine.



reddot award
honourable mention industrial design



Key advantages

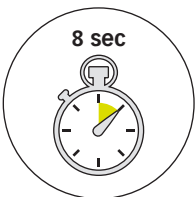

Clamp the tool safely and securely by pushing just one button. The clamping will take 8 seconds, without the use of heat.

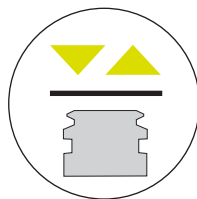

Clamp tools with maximum clamping force and best runout in the powRgrip® collet and toolholder.

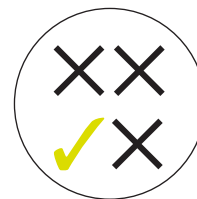

Smart System – no setting of parameters required. Clamping pressure is controlled by the insertion of the respective clamping insert (APG). There are five clamping inserts (APG) available for the clamping of different collet sizes.

Automatic clamping unit PGU 9500

Clamping inserts APG's for PGU 9500

PGU 9500

APG

Type	Part no.	Dimensions W x D x H [mm]	Weight [kg]	V/Hz
PGU 9500				
PGU 9500 E	7610.95000	555 x 454 x 648	87	Europe 230V/50Hz
PGU 9500 A	7610.95100	555 x 454 x 648	91	USA 115V/60Hz
PGU 9500 J	7610.95200	555 x 454 x 648	91	Japan 100V/50-60Hz

Clamping inserts APG not included

Type	Part no.	Dimensions W x D x H [mm]	Weight [kg]	Use for
Clamping inserts APG (incl. TKCP and CPS)				
APG 906*	7611.06900	100 x 95 x 80	3	PG 6
APG 910	7611.10900	100 x 95 x 80	3	PG 10
APG 915	7611.15900	100 x 95 x 80	3	PG 15
APG 925	7611.25900	100 x 95 x 80	3	PG 25
APG 932	7611.32900	100 x 95 x 80	3	PG 32

*APG 906 is only suited for PGU 9006 and 9500. All other APG's can be used for PGU 9000/9006/9500

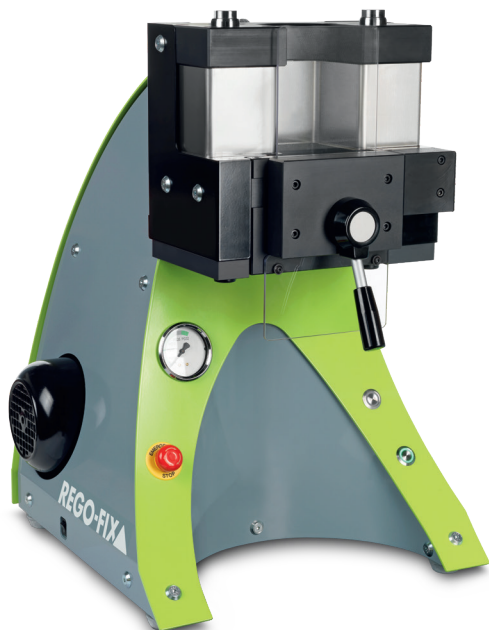

PGU 9500

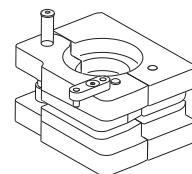

APG (closed)

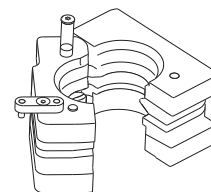

APG (opened)

Manual clamping unit PGC 2506

Clamping inserts APC's for PGC 2506

PGC

APC

Type	Part no.	Dimensions W x D x H [mm]	Weight [kg]
PGC			
SET PGC 2506	7621.25069	578 x 420 x 43	18.2

Includes clamping unit, hand pump and stand. APC not included

Type	Part no.	Dimensions Ø [mm]	Weight [kg]	Use for
Clamping inserts APC (incl. TKCP and CPS)				
APC 6	7622.06000	30 x 60	0.8	PG 6
APC 10	7622.10000	30 x 60	0.8	PG 10
APC 15	7622.15000	30 x 60	0.8	PG 15
APC 25	7622.25000	30 x 60	0.8	PG 25

**APC 6 is only suited for SET PGC 2506. All other APC's can be used for SET PGC 2506 and 2510*



PGC 2506

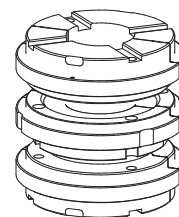

APC

Standard

Cylindrical
colletholders

Pullout protection
secuRgrip®

Colletholders
for tapping

HSK/
PG



page 12

SK/
PG



page 18

BT/
PG



page 24

CAT/
PG



page 32

CAPTO/
PG



page 36

ISO 20/
PG



page 39

CYL/
PG



page 40

PG-SG



page 42

HSK-A
SSY



page 46

CYL SSY
CYL GSF



page 46



powRgrip® toolholders in Swiss quality



	HSK/PG	SK/PG	BT/PG	CAT/PG	CAPTO/PG
Norm	DIN 69893	DIN 69871	MAS 403 JIS B 6339	ASME B5.50	–
ISO	ISO 12164	ISO 7388-1	ISO 7388-2	–	ISO 26623
Balancing	G 2.5 @ 25,000 rpm or ≤1 gmm	G 2.5 @ 25,000 rpm or ≤1 gmm	G 2.5 @ 25,000 rpm or ≤1 gmm	G 2.5 @ 25,000 rpm or ≤1 gmm	G 2.5 @ 25,000 rpm or ≤1 gmm
Chip hole	HSK-A	•	–	–	–
Runout TIR	≤0.003 mm	≤0.003 mm	≤0.003 mm	≤0.003 mm	≤0.003 mm
Taper accuracy	DIN ISO	AT3	AT3	AT3	ISO 26623
Form A + AD	–	•	•	•	–
Form AD + B	–	optional	optional	optional	–
secuRgrip®	optional	optional	optional	optional	optional
REGO-PLUS available	–	•	•	•	–

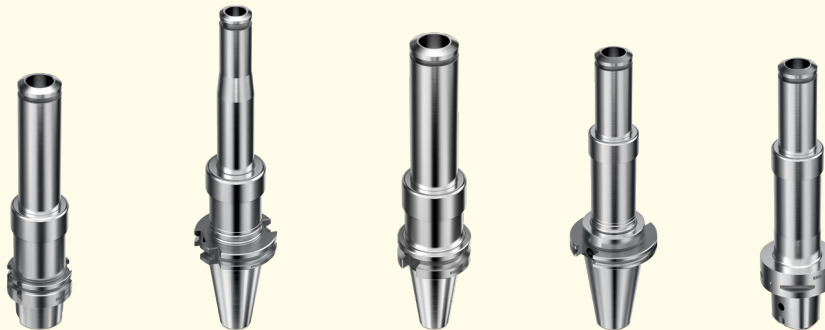

	HSK-A/PG XL	SK/PG XL	BT/PG XL	CAT/PG XL	CAPTO/PG XL
Norm	DIN 69893	DIN 69871	MAS 403 JIS B 6339	ASME B5.50	–
ISO	ISO 12164	ISO 7388-1	ISO 7388-2	–	ISO 26623
Balancing	G 2.5 @ 5,000 rpm	G 2.5 @ 5,000 rpm	G 2.5 @ 5,000 rpm	G 2.5 @ 5,000 rpm	G 2.5 @ 5,000 rpm
Chip hole	HSK-A	•	–	–	–
Runout TIR	≤0.01 mm	≤0.01 mm	≤0.01 mm	≤0.01 mm	≤0.01 mm
Taper accuracy	DIN ISO	AT3	AT3	AT3	ISO 26623
MFD*	•	•	•	•	•
Form A + AD	–	•	•	•	–
Form AD + B	–	optional	optional	optional	–
secuRgrip®	optional	optional	optional	optional	optional

*micro friction dampening technology

HSK toolholders

Designed for rotating applications, all our HSK toolholders are suited for high-speed applications where consistent performance is key.

DIN 69893 / ISO 12164

Features and benefits

Total system runout TIR $\leq 3\mu\text{m}$ @ 3xD

Our holistic system consists of a powRgrip® toolholder and collet. All components together ensure best runout and accuracy.

Toolholder runout TIR $\leq 1\mu\text{m}$

Measured from collet cavity to outer taper.

Surface finish max. Ra 0.25

Achieve high clamping force and high transferable torque.

Hi-Q® balancing system

REGO-FIX HSK / PG toolholders are balanced to G 2.5 @ 25,000 rpm / <1gmm. Type H toolholders are ready to accept Hi-Q® balancing rings which allow precision-balancing of the system including cutting tool up to 80.000 rpm depending on the balancing rings used.

XL toolholders

Total system runout TIR $\leq 10\mu\text{m}$
100% balanced to G 2.5 @ 5,000 rpm.

Vibration dampening

Our holders offer excellent vibration dampening to sustain a high surface finish and can prevent cutting force alterations.

Matched tooling system for best fit

For highest precision and best results the entire machining system counts. Therefore our components are carefully matched for optimum fit and accuracy. This guarantees the best runout and balance.

ID chip hole (only HSK form A)

In accordance with DIN 69873 for 10 mm diameter. Other HSK-forms available on request.

Accessories are not included in delivery. Other XL sizes available on request

Balancing specifications

HSK 20	balanced to 90,000 rpm
HSK 25	balanced to 90,000 rpm
HSK 32	balanced to 60,000 rpm
HSK 40	balanced to 45,000 rpm
HSK 50	balanced to 36,000 rpm
HSK 63	G 2.5 @ 25,000 rpm
HSK 80	G 2.5 @ 25,000 rpm
HSK 100	G 2.5 @ 25,000 rpm
HSK 125	G 2.5 @ 25,000 rpm



Expert advice

For all HSK-A and HSK-E form toolholders a range of coolant tubes (KSR) is available.

For KSR part numbers please refer to page 265.

HSK-A toolholders

HSK-A

DIN 69893

ISO 12164

Type	Part no.	Dimensions [mm]						Accessory
		D	D1	D2	L	L1	L2	FWR *
HSK-A 32								
HSK-A 32/PG 10 x 060	2532.71020	16	-	-	60	-	-	-
HSK-A 32/PG 15 x 075	2532.71530	24	-	-	75	-	-	-
HSK-A 40								
HSK-A 40/PG 6 x 048	2540.70610	10	-	-	48	-	-	-
HSK-A 40/PG 6 x 080 H	4540.70640	10	-	-	80	-	-	225
HSK-A 40/PG 10 x 062	2540.71020	16	-	-	62	-	-	-
HSK-A 40/PG 10 x 080 H	4540.71040	16	-	-	80	-	-	225
HSK-A 40/PG 10 x 120 H	4540.71060	16	-	-	120	-	-	225
HSK-A 40/PG 15 x 074	2540.71530	24	-	-	74	-	-	-
HSK-A 40/PG 15 x 080 H	4540.71540	24	-	-	80	-	-	285
HSK-A 40/PG 25 x 090	2540.72540	40	-	-	90	-	-	-
HSK-A 40/PG 25 x 100 H	4540.72550	40	-	-	100	-	-	405
HSK-A 50								
HSK-A 50/PG 10 x 080 H	4550.71040	16	-	-	80	-	-	285
HSK-A 50/PG 10 x 120 H	4550.71060	16	-	-	120	-	-	285
HSK-A 50/PG 15 x 080 H	4550.71540	24	-	-	80	-	-	285
HSK-A 50/PG 25 x 100 H	4550.72550	40	-	-	100	-	-	405
HSK-A 63								
HSK-A 63/PG 6 x 080 H	4563.70640	10	-	-	80	-	-	225
HSK-A 63/PG 10 x 080 H	4563.71040	16	-	-	80	-	-	325
HSK-A 63/PG 10 x 120 H	4563.71060	16	-	-	120	-	-	325
HSK-A 63/PG 10 x 160 H	4563.71080	16	-	-	160	-	-	325
HSK-A 63/PG 10 x 200 H	4563.71090	16	-	-	200	-	-	325
HSK-A 63/PG 10 x 240 XL	8865.71070	16	46	28	240	140	31	-
HSK-A 63/PG 10 x 260 XL	8865.71090	16	46	28	260	140	31	-
HSK-A 63/PG 10 x 300 XL	8865.71130	16	46	28	300	140	31	-
HSK-A 63/PG 10 x 340 XL	8865.71170	16	46	28	340	240	31	-
HSK-A 63/PG 10 x 360 XL	8865.71190	16	46	28	360	240	31	-
HSK-A 63/PG 10 x 400 XL	8865.71230	16	46	28	400	240	31	-
HSK-A 63/PG 15 x 080 H	4563.71540	24	-	-	80	-	-	325
HSK-A 63/PG 15 x 120 H	4563.71560	24	-	-	120	-	-	325
HSK-A 63/PG 15 x 160 H	4563.71580	24	-	-	160	-	-	325/285
HSK-A 63/PG 15 x 240 XL	8865.73070	24	46	28	240	140	55	-

*Balancing rings H: Ready to accept balancing rings

Type	Part no.	Dimensions [mm]							Accessory
		D	D1	D2	L	L1	L2	FWR*	
HSK-A 63/PG 15 x 260 XL	8865.73090	24	46	28	260	140	55	–	
HSK-A 63/PG 15 x 300 XL	8865.73130	24	46	28	300	140	55	–	
HSK-A 63/PG 15 x 340 XL	8865.73170	24	46	28	340	240	55	–	
HSK-A 63/PG 15 x 360 XL	8865.73190	24	46	28	360	240	55	–	
HSK-A 63/PG 15 x 400 XL	8865.73230	24	46	28	400	240	55	–	
HSK-A 63/PG 25 x 085 H NL**	4563.72540	40	–	–	85	–	–	405	
HSK-A 63/PG 25 x 100 H	4563.72550	40	–	–	100	–	–	405	
HSK-A 63/PG 25 x 120 H	4563.72560	40	–	–	120	–	–	405	
HSK-A 63/PG 25 x 160 H	4563.72580	40	–	–	160	–	–	405 / 405	
HSK-A 63/PG 25 x 200 H	4563.72590	40	–	–	200	–	–	405 / 405	
HSK-A 63/PG 25 x 240 XL	8865.76070	40	55	–	240	140	–	–	
HSK-A 63/PG 25 x 260 XL	8865.76090	40	55	–	260	140	–	–	
HSK-A 63/PG 25 x 340 XL	8865.76170	40	55	–	340	240	–	–	
HSK-A 63/PG 25 x 360 XL	8865.76190	40	55	–	360	240	–	–	
HSK-A 63/PG 32 x 100	2563.73250	50	–	–	100	–	–	–	
HSK-A 63/PG 32 x 120 H	4563.73260	50	–	–	120	–	–	505	
HSK-A 63/PG 32 x 240 XL	8865.78070	50	58	–	240	140	–	–	
HSK-A 63/PG 32 x 260 XL	8865.78090	50	58	–	260	140	–	–	
HSK-A 63/PG 32 x 340 XL	8865.78170	50	58	–	340	240	–	–	
HSK-A 63/PG 32 x 360 XL	8865.76190	50	58	–	360	240	–	–	

HSK-A 80

HSK-A 80/PG 15 x 085 H	4580.71540	24	–	–	85	–	–	325
HSK-A 80/PG 25 x 100 H	4580.72550	40	–	–	100	–	–	505
HSK-A 80/PG 32 x 105 H	4580.73250	50	–	–	105	–	–	505

*Balancing rings H: Ready to accept balancing rings

HSK-A: Hole for data carrier DIN STD 69873 in the flange available on request

**Collets PG-L, PG-MQL and PG-CRYO cannot be used

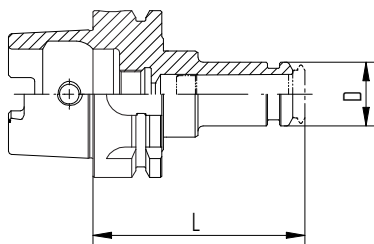

HSK-A/PG

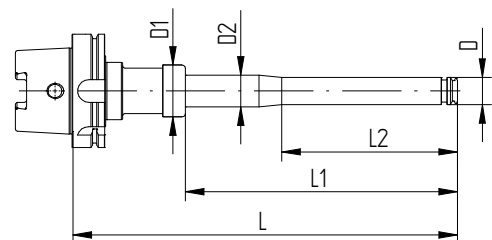

HSK-A/PG XL

HSK-A toolholders

HSK-A

DIN 69893

ISO 12164

powRgrip®

Type	Part no.	Dimensions [mm]						Accessory
		D	D1	D2	L	L1	L2	FWR*
HSK-A 100								
HSK-A 100/PG 10 x 085 H	4500.71040	16	–	–	85	–	–	405
HSK-A 100/PG 10 x 160 H	4500.71080	16	–	–	160	–	–	405
HSK-A 100/PG 10 x 240 XL	8885.71070	16	46	28	240	140	31	–
HSK-A 100/PG 10 x 300 XL	8885.71130	16	46	28	300	140	31	–
HSK-A 100/PG 10 x 340 XL	8885.71170	16	46	28	340	240	31	–
HSK-A 100/PG 10 x 400 XL	8885.71230	16	46	28	400	240	31	–
HSK-A 100/PG 15 x 085 H	4500.71540	24	–	–	85	–	–	405
HSK-A 100/PG 15 x 120 H	4500.71560	24	–	–	120	–	–	405
HSK-A 100/PG 15 x 160 H	4500.71580	24	–	–	160	–	–	405 / 285
HSK-A 100/PG 15 x 240 XL	8885.73070	24	46	28	240	140	55	–
HSK-A 100/PG 15 x 300 XL	8885.73110	24	46	28	300	140	55	–
HSK-A 100/PG 15 x 340 XL	8885.73170	24	46	28	340	240	55	–
HSK-A 100/PG 15 x 400 XL	8885.73230	24	46	28	400	240	55	–
HSK-A 100/PG 25 x 100 H	4500.72550	40	–	–	100	–	–	505
HSK-A 100/PG 25 x 120 H	4500.72560	40	–	–	120	–	–	505
HSK-A 100/PG 25 x 160 H	4500.72580	40	–	–	160	–	–	505 / 405
HSK-A 100/PG 25 x 200 H	4500.72590	40	–	–	200	–	–	505 / 405
HSK-A 100/PG 25 x 246 XL	8885.76070	40	55	–	246	140	–	–
HSK-A 100/PG 25 x 260 XL	8885.76090	40	55	–	260	140	–	–
HSK-A 100/PG 25 x 300 XL	8885.76130	40	55	–	300	140	–	–
HSK-A 100/PG 25 x 346 XL	8885.76170	40	55	–	346	240	–	–
HSK-A 100/PG 25 x 360 XL	8885.76190	40	55	–	360	240	–	–
HSK-A 100/PG 25 x 400 XL	8885.76230	40	55	–	400	240	–	–
HSK-A 100/PG 25 x 440 XL	8885.76270	40	55	–	440	240	–	–
HSK-A 100/PG 32 x 106 H	4500.73250	50	–	–	106	–	–	505
HSK-A 100/PG 32 x 120 H	4500.73260	50	–	–	120	–	–	505
HSK-A 100/PG 32 x 160 H	4500.73280	50	–	–	160	–	–	505
HSK-A 100/PG 32 x 200 H	4500.73290	50	–	–	200	–	–	505 / 505
HSK-A 100/PG 32 x 246 XL	8885.78070	50	58	–	246	140	–	–
HSK-A 100/PG 32 x 260 XL	8885.78090	50	58	–	260	140	–	–
HSK-A 100/PG 32 x 300 XL	8885.78130	50	58	–	300	140	–	–
HSK-A 100/PG 32 x 340 XL	8885.78170	50	58	–	340	140	–	–
HSK-A 100/PG 32 x 360 XL	8885.78190	50	58	–	360	240	–	–
HSK-A 100/PG 32 x 400 XL	8885.78230	50	58	–	400	240	–	–
HSK-A 100/PG 32 x 440 XL	8885.78270	50	58	–	440	240	–	–
HSK-A 125								
HSK-A 125/PG 15 x 245 XL	8895.73070	24	52	28	245	140	55	–
HSK-A 125/PG 15 x 345 XL	8895.73170	24	52	28	345	240	55	–
HSK-A 125/PG 25 x 252 XL	8895.76080	40	52	–	252	140	–	–
HSK-A 125/PG 25 x 352 XL	8895.76180	40	52	–	352	240	–	–
HSK-A 125/PG 32 x 252 XL	8895.78080	50	58	–	252	140	–	–
HSK-A 125/PG 32 x 352 XL	8895.78180	50	58	–	352	240	–	–

*Balancing rings H: Ready to accept balancing rings

HSK-A: Hole for data carrier DIN STD 69873 in the flange available on request

HSK-E toolholders

HSK-E

DIN 69893

ISO 12164

Type	Part no.	Dimensions [mm]						Accessory
		D	D1	D2	L	L1	L2	FWR*
HSK-E 20								
HSK-E 20/PG 6 x 043	2520.70614	10	-	-	43	-	-	-
HSK-E 25								
HSK-E 25/PG 6 x 043	2525.70614	10	-	-	43	-	-	-
HSK-E 25/PG 10 x 055	2525.71014	16	-	-	55	-	-	-
HSK-E 32								
HSK-E 32/PG 6 x 048	2532.70614	10	-	-	48	-	-	-
HSK-E 32/PG 6 x 080	2532.70644	10	-	-	80	-	-	-
HSK-E 32/PG 10 x 060	2532.71024	16	-	-	60	-	-	-
HSK-E 32/PG 10 x 080	2532.71044	16	-	-	80	-	-	-
HSK-E 32/PG 10 x 080 H	4532.71044	16	-	-	80	-	-	225
HSK-E 32/PG 15 x 075	2532.71534	24	-	-	75	-	-	-
HSK-E 40								
HSK-E 40/PG 6 x 048	2540.70614	10	-	-	48	-	-	-
HSK-E 40/PG 6 x 080 H	4540.70644	10	-	-	80	-	-	225
HSK-E 40 NCT/PG 10 x 052**	2540.71018	16	-	-	52	-	-	-
HSK-E 40/PG 10 x 062	2540.71024	16	-	-	62	-	-	-
HSK-E 40/PG 10 x 080 H	4540.71044	16	-	-	80	-	-	225
HSK-E 40/PG 10 x 120 H	4540.71064	16	-	-	120	-	-	225
HSK-E 40/PG 10 x 160 H	4540.71084	16	-	-	160	-	-	285
HSK-E 40 NCT/PG 15 x 064**	2540.71528	24	-	-	64	-	-	-
HSK-E 40/PG 15 x 074	2540.71534	24	-	-	74	-	-	-
HSK-E 40/PG 15 x 080 H	4540.71544	24	-	-	80	-	-	285
HSK-E 40/PG 15 x 120 H	4540.71564	24	-	-	120	-	-	285
HSK-E 40/PG 25 x 090	2540.72544	40	-	-	90	-	-	-
HSK-E 40/PG 25 x 100 H	4540.72554	40	-	-	100	-	-	405
HSK-E 50								
HSK-E 50/PG 6 x 080 H	4550.70644	10	-	-	80	-	-	225
HSK-E 50/PG 10 x 067	2550.71024	16	-	-	67	-	-	-
HSK-E 50/PG 10 x 080 H	4550.71044	16	-	-	80	-	-	285
HSK-E 50/PG 10 x 120 H	4550.71064	16	-	-	120	-	-	285
HSK-E 50/PG 10 x 160 H	4550.71084	16	-	-	160	-	-	285
HSK-E 50/PG 15 x 080 H	4550.71544	24	-	-	80	-	-	285
HSK-E 50/PG 15 x 120 H	4550.71564	24	-	-	120	-	-	285
HSK-E 50/PG 25 x 100 H	4550.72554	40	-	-	100	-	-	405
HSK-E 63								
HSK-E 63/PG 15 x 080 H	4563.71544	24	-	-	80	-	-	325
HSK-E 63/PG 25 x 100 H	4563.72554	40	-	-	100	-	-	405

*Balancing rings H: Ready to accept balancing rings

**Without thread for coolant tube

HSK-F toolholders

HSK-F

DIN 69893

ISO 12164

powRgrip®

Type	Part no.	Dimensions [mm]						Accessory
		D	D1	D2	L	L1	L2	FWR*
HSK-F 63								
HSK-F 63/PG 10 x 080 H	4563.71045	16	-	-	80	-	-	325
HSK-F 63/PG 10 x 120 H	4563.71065	16	-	-	120	-	-	325
HSK-F 63/PG 10 x 160 H	4563.71085	16	-	-	160	-	-	325
HSK-F 63/PG 15 x 080 H	4563.71545	24	-	-	80	-	-	325
HSK-F 63/PG 15 x 120 H	4563.71565	24	-	-	120	-	-	325
HSK-F 63/PG 15 x 160 H	4563.71585	24	-	-	160	-	-	325/285
HSK-F 63/PG 25 x 100 H	4563.72555	40	-	-	100	-	-	405
HSK-F 63/PG 25 x 160 H	4563.72585	40	-	-	160	-	-	405
HSK-F 63/PG 32 x 100	2563.73255	50	-	-	100	-	-	-

HSK-FP 80**								
HSK-FP 80/PG 25 x 090 H	8020.13200	40	-	-	90	-	-	405
HSK-FP 80/PG 32 x 100 H	8020.13100	50	-	-	100	-	-	505

*Balancing rings H: Ready to accept balancing rings

**USA only

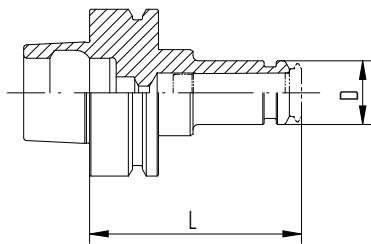

HSK-F/PG

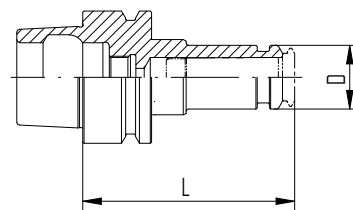

HSK-E/PG

SK steep taper toolholders

Universally suitable for different machining applications.

DIN 69871 / DIN ISO 7388-1

Features and benefits

Total system runout TIR $\leq 3 \mu\text{m}$ @ 3xD

Our holistic system consists of a powRgrip® toolholder and collet. All components together ensure best runout and accuracy.

Toolholder runout TIR $\leq 1 \mu\text{m}$

Measured from collet cavity to outer taper.

Taper accuracy AT3

Better spindle-to-holder fit and accuracy.

Surface finish max. Ra 0.25

Achieve high clamping force and high transferable torque.

Balancing

100% balanced to G 2.5 @ 25,000 rpm / < 1gmm.

XL toolholders

Total system runout TIR $\leq 10 \mu\text{m}$
100% balanced to G 2.5 @ 5,000 rpm.

Hi-Q® balancing system

Ready to accept Hi-Q® balancing rings which allow for the offset of the imbalance introduced by the cutting tool up to 80,000 rpm depending on the balancing rings used. All toolholders with the additional type information "H" in the part number are designed for balancing rings.

Vibration dampening

Our holders offer excellent vibration dampening to sustain a high surface finish and can help prevent chatter.

ID chip hole

In accordance with DIN 69873 for 10 mm diameter.

Balancing specifications

SK 30	balanced to 30,000 rpm
SK 40	G 2.5 @ 25,000 rpm
SK 50	G 2.5 @ 25,000 rpm

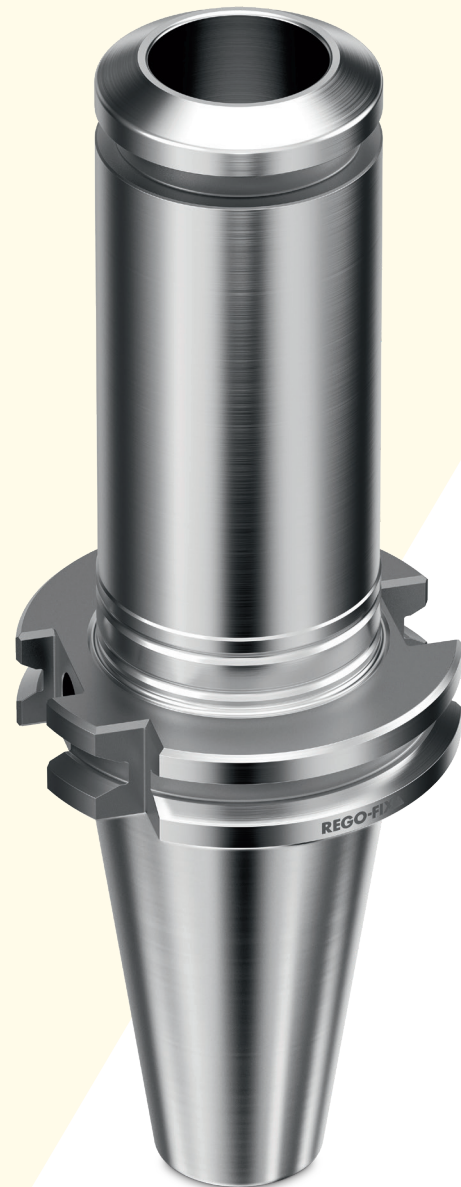

Accessories are not included in delivery. Other XL sizes available on request

Type	Part no.	Dimensions [mm]						Accessory
		D	D1	D2	L	L1	L2	FWR*
SK 30								
SK 30/PG 6 x 080 H	4230.70640	10	-	-	80	-	-	225
SK 30/PG 10 x 060	2230.71020	16	-	-	60	-	-	-
SK 30/PG 10 x 073 H	4230.71030	16	-	-	73	-	-	285
SK 30/PG 15 x 060	2230.71520	24	-	-	60	-	-	-
SK 30/PG 15 x 080 H	4230.71540	24	-	-	80	-	-	285
SK 30/PG 15 x 120 H	4230.71560	24	-	-	120	-	-	285
SK 30/PG 25 x 080	2230.72540	40	-	-	80	-	-	-
SK 30/PG 25 x 160 H	4230.72580	40	-	-	160	-	-	405
SK 40								
SK 40/PG 10 x 080 H	4240.71040	16	-	-	80	-	-	285
SK 40/PG 10 x 120 H	4240.71060	16	-	-	120	-	-	285
SK 40/PG 10 x 160 H	4240.71080	16	-	-	160	-	-	325
SK 40/PG 10 x 220 XL	8842.71050	16	46	28	220	140	31	-
SK 40/PG 10 x 260 XL	8842.71090	16	46	28	260	140	31	-
SK 40/PG 10 x 300 XL	8842.71130	16	46	28	300	140	31	-
SK 40/PG 10 x 320 XL	8842.71150	16	46	28	320	240	31	-
SK 40/PG 10 x 360 XL	8842.71190	16	46	28	360	240	31	-
SK 40/PG 10 x 400 XL	8842.71230	16	46	28	400	240	31	-
SK 40/PG 15 x 072	2240.71530	24	-	-	72	-	-	-
SK 40/PG 15 x 080 H	4240.71540	24	-	-	80	-	-	285
SK 40/PG 15 x 120 H	4240.71560	24	-	-	120	-	-	325
SK 40/PG 15 x 160 H	4240.71580	24	-	-	160	-	-	325/285
SK 40/PG 15 x 220 XL	8842.73050	24	46	28	220	140	55	-
SK 40/PG 15 x 260 XL	8842.73090	24	46	28	260	140	55	-
SK 40/PG 15 x 300 XL	8842.73130	24	46	28	300	140	55	-
SK 40/PG 15 x 320 XL	8842.73150	24	46	28	320	240	55	-
SK 40/PG 15 x 360 XL	8842.73190	24	46	28	360	240	55	-
SK 40/PG 15 x 400 XL	8842.73230	24	46	28	400	240	55	-
SK 40/PG 25 x 072	2240.72530	40	-	-	72	-	-	-
SK 40/PG 25 x 080 H	4240.72540	40	-	-	80	-	-	405
SK 40/PG 25 x 120 H	4240.72560	40	-	-	120	-	-	405
SK 40/PG 25 x 160 H	4240.72580	40	-	-	160	-	-	405/405
SK 40/PG 25 x 220 XL	8842.76050	40	55	-	220	140	-	-
SK 40/PG 25 x 320 XL	8842.76150	40	55	-	320	240	-	-
SK 40/PG 32 x 080	2240.73240	50	-	-	80	-	-	-

*Balancing rings H: Ready to accept balancing rings

Type	Part no.	Dimensions [mm]						Accessory
		D	D1	D2	L	L1	L2	FWR*
SK-B 40								
SK-B 40/PG 10 x 080 H	4240.71043	16	-	-	80	-	-	285
SK-B 40/PG 10 x 120 H	4240.71063	16	-	-	120	-	-	285
SK-B 40/PG 10 x 160 H	4240.71083	16	-	-	160	-	-	325
SK-B 40/PG 15 x 072	2240.71533	24	-	-	72	-	-	-
SK-B 40/PG 15 x 080 H	4240.71543	24	-	-	80	-	-	285
SK-B 40/PG 15 x 120 H	4240.71563	24	-	-	120	-	-	325
SK-B 40/PG 15 x 160 H	4240.71583	24	-	-	160	-	-	325/285
SK-B 40/PG 25 x 072	2240.72533	40	-	-	72	-	-	-
SK-B 40/PG 25 x 080 H	4240.72543	40	-	-	80	-	-	405
SK-B 40/PG 25 x 120 H	4240.72563	40	-	-	120	-	-	405
SK-B 40/PG 25 x 160 H	4240.72583	40	-	-	160	-	-	405/405
SK-B 40/PG 32 x 080	2240.73243	50	-	-	80	-	-	-

*Balancing rings H: Ready to accept balancing rings

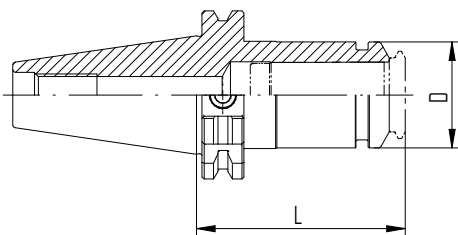

SK/PG (Form A+AD)

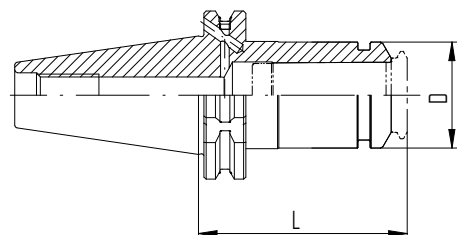

SK-B/PG (Form AD+B)

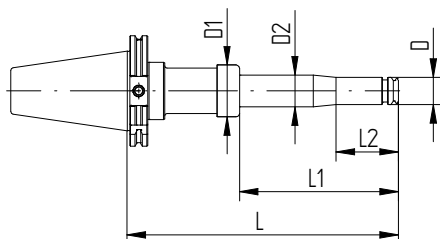

SK/PG XL

SK toolholders

SK-B toolholders

SK

DIN 69871

DIN ISO 7388-1

SK-B

DIN 69871

DIN ISO 7388-1

Type	Part no.	Dimensions [mm]						Accessory
		D	D1	D2	L	L1	L2	FWR*
SK 50								
SK 50/PG 10 x 240 XL	8852.71070	16	46	28	240	140	31	–
SK 50/PG 10 x 300 XL	8852.71130	16	46	28	300	140	31	–
SK 50/PG 10 x 340 XL	8852.71170	16	46	28	340	240	31	–
SK 50/PG 10 x 400 XL	8852.71230	16	46	28	400	240	31	–
SK 50/PG 15 x 120 H	4250.71560	24	32	–	120	42	–	325
SK 50/PG 15 x 240 XL	8852.73070	24	46	28	240	140	55	–
SK 50/PG 15 x 300 XL	8852.73130	24	46	28	300	140	55	–
SK 50/PG 15 x 340 XL	8852.73170	24	46	28	340	240	55	–
SK 50/PG 15 x 400 XL	8852.73230	24	46	28	400	240	55	–
SK 50/PG 25 x 081	2250.72540	40	–	–	81	–	–	–
SK 50/PG 25 x 100 H	4250.72550	40	–	–	100	–	–	505
SK 50/PG 25 x 160 H	4250.72580	40	–	–	160	–	–	505/405
SK 50/PG 25 x 200 H	4250.72590	40	–	–	200	–	–	505/405
SK 50/PG 25 x 300 XL	8832.78130	40	55	–	134	–	–	–
SK 50/PG 25 x 320 XL	8852.76150	40	55	–	320	240	–	–
SK 50/PG 25 x 400 XL	8852.76230	40	55	–	234	–	–	–
SK 50/PG 32 x 080	2250.73240	50	–	–	80	–	–	–
SK 50/PG 32 x 160 H	4250.73280	50	–	–	160	–	–	505
SK 50/PG 32 x 220 XL	8852.78050	50	58	–	220	140	–	–
SK 50/PG 32 x 300 XL	8852.78130	50	58	–	300	140	–	–
SK 50/PG 32 x 320 XL	8852.78150	50	58	–	320	240	–	–
SK 50/PG 32 x 400 XL	8852.78230	50	58	–	400	240	–	–

SK-B 50								
SK-B 50/PG 25 x 081	2250.72543	40	–	–	81	–	–	–
SK-B 50/PG 25 x 100 H	4250.72553	40	–	–	100	–	–	505
SK-B 50/PG 25 x 160 H	4250.72583	40	–	–	160	–	–	505/405
SK-B 50/PG 25 x 200 H	4250.72593	40	–	–	200	–	–	505/405
SK-B 50/PG 32 x 080	2250.73243	50	–	–	80	–	–	–

*Balancing rings H: Ready to accept balancing rings

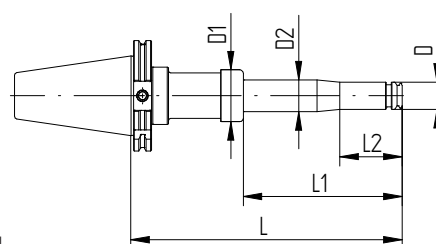
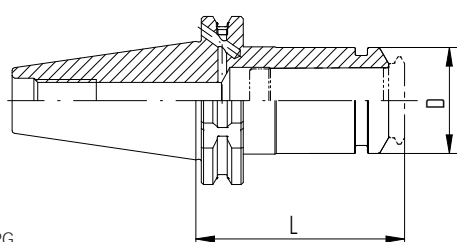
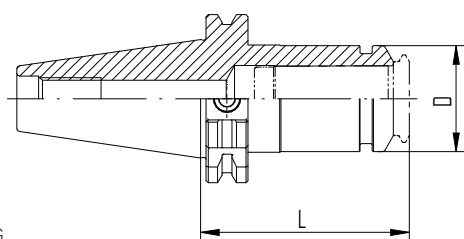

REGO-FIX SK+ toolholders

Key advantages

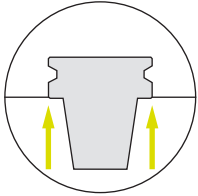

Higher colletholder stiffness due to taper (AT1) and face contact.

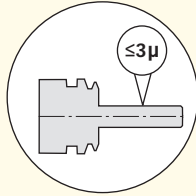

Improved machining accuracy and better surface finish.

Certified The BIG PLUS SYSTEM – licensed by BIG Daishowa – is manufactured at REGO-FIX in Switzerland under license according to BIG PLUS specifications.

DIN 69871 / DIN ISO 7388-1

Features and benefits

Total system runout TIR $\leq 0.0001''$ (3 μm)

Our holistic system consists of a powRgrip® toolholder and collet. All components together ensure best runout and accuracy.

Surface finish max. Ra 0.25

Achieve high clamping force and high transferable torque.

Balancing

100% balanced to G 2.5 @ 25,000 rpm/ ≤ 1 gmm.

Hi-Q® balancing system

Ready to accept Hi-Q® balancing rings which allow for the offset of the imbalance introduced by the cutting tool up to 80,000 rpm depending on the balancing rings used. All colletholders with the additional type information "H" in the article name are designed for balancing rings.

Vibration dampening

Our holders offer excellent vibration dampening to sustain a high surface finish and can help prevent chatter.

ID chip hole

In accordance DIN 69873 with diameter 10 mm.

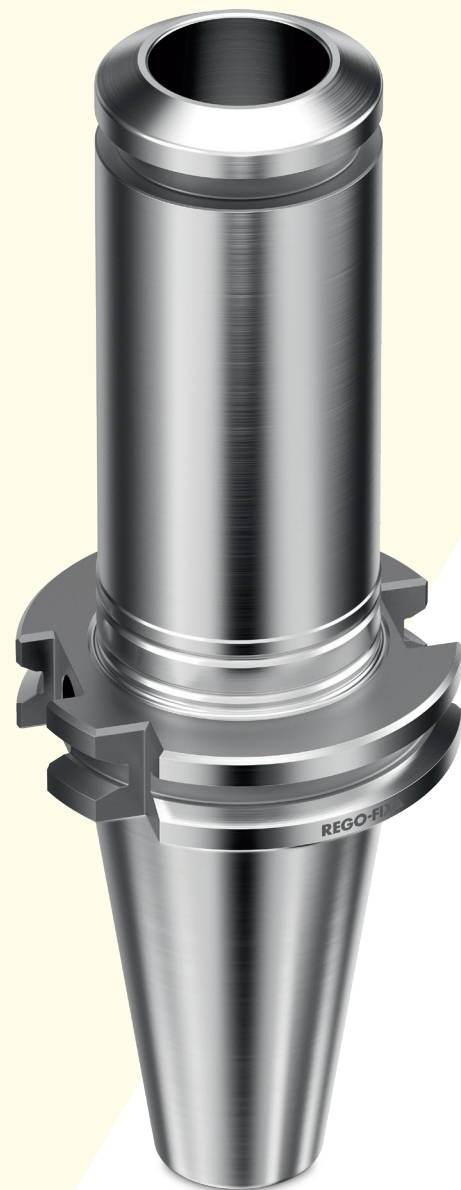

Accessories are not included in delivery. Form B available on request

SK+ toolholder

SK+

DIN 69871

DIN ISO 7388-1

powRgrip®

Type	Part. no.	Dimensions [mm]		Accessory
		D	L	FWR*
SK+ 40				
SK+ 40 / PG 10 x 080 H	4240.71046	16	80	285
SK+ 40 / PG 15 x 080 H	4240.71546	24	80	285
SK+ 40 / PG 25 x 080 H	4240.72546	40	80	405
SK+ 40 / PG 32 x 080	2240.73246	50	80	–

*Balancing rings H: Ready to accept balancing rings

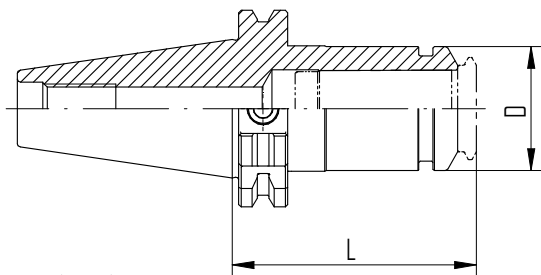

SK+ / PG (A+AD)

BT steep taper toolholders

Universally suitable for different machining applications, the BT interface toolholders cater to different machining needs.

MAS 403 / JIS B 6339 / DIN ISO 7388-2

Features and benefits

Total system runout TIR $\leq 3 \mu\text{m}$ @ 3xD

Our holistic system consists of a powRgrip® toolholder and collet. All components together ensure best runout and accuracy.

Toolholder runout TIR $\leq 1 \mu\text{m}$

Measured from collet cavity to outer taper.

Taper accuracy AT3

Better spindle-to-holder fit and accuracy.

Surface finish max. Ra 0.25

Achieve high clamping force and high transferable torque.

Balancing

100% balanced to G 2.5 @ 25,000 rpm / < 1gmm.

XL toolholders

Total system runout TIR $\leq 10 \mu\text{m}$
100% balanced to G 2.5 @ 5,000 rpm.

Hi-Q® balancing system

Ready to accept Hi-Q® balancing rings which allow for the offset of the imbalance introduced by the cutting tool up to 80,000 rpm depending on the balancing rings used. All toolholders with the additional type information "H" in the part number are designed for balancing rings.

Vibration dampening

Our holders offer excellent vibration dampening to sustain a high surface finish and can help prevent chatter.

Balancing specifications

BT 30	balanced to 30,000 rpm
BT 40	G 2.5 @ 25,000 rpm
BT 50	G 2.5 @ 25,000 rpm



Accessories are not included in delivery. Other XL sizes available on request

BT toolholders

BT

MAS 403

JIS B 6339

DIN ISO 7388-2

powRgrip®

Type	Part no.	Dimensions [mm]						Accessory
		D	D1	D2	L	L1	L2	FWR*
BT 30								
BT 30/PG 6 x 050	2130.70610	10	-	-	50	-	-	-
BT 30/PG 6 x 080 H	4130.70640	10	-	-	80	-	-	225
BT 30/PG 6 x 100 H	4130.70650	10	-	-	100	-	-	225
BT 30/PG 10 x 062	2130.71020	16	-	-	62	-	-	-
BT 30/PG 10 x 080 H	4130.71040	16	-	-	80	-	-	285
BT 30/PG 10 x 120 H	4130.71060	16	-	-	120	-	-	285
BT 30/PG 10 x 160 H	4130.71080	16	-	-	160	-	-	285
BT 30/PG 15 x 065	2130.71520	24	-	-	65	-	-	-
BT 30/PG 15 x 070 H	4130.71530	24	-	-	70	-	-	285
BT 30/PG 15 x 120 H	4130.71560	24	-	-	120	-	-	285
BT 30/PG 25 x 075	2130.72530	40	-	-	75	-	-	-
BT 30/PG 25 x 080 H	4130.72540	40	-	-	80	-	-	405
BT 30/PG 25 x 120 H	4130.72560	40	-	-	120	-	-	405
BT 30/PG 25 x 160 H	4130.72580	40	-	-	160	-	-	405/405

*Balancing rings H: Ready to accept balancing rings

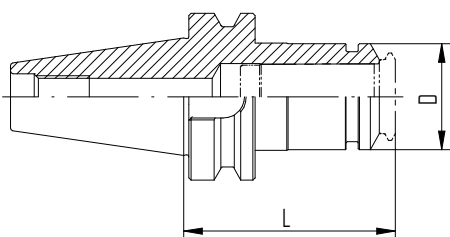

BT/PG

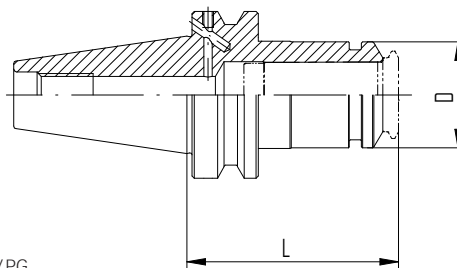

BT-B/PG

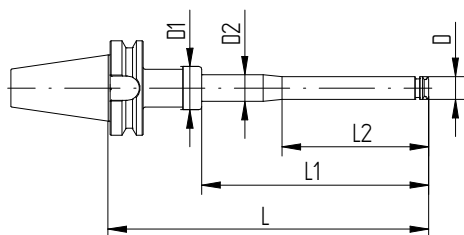

BT/PG XL

BT toolholders

BT-B toolholders

BT	BT-B
MAS 403	MAS 403
JIS B 6339	JIS B 6339
DIN ISO 7388-2	DIN ISO 7388-2

Type	Part no.	Dimensions [mm]						Accessory
		D	D1	D2	L	L1	L2	FWR*
BT 40								
BT 40/PG 10 x 080 H	4140.71040	16	–	–	80	–	–	285
BT 40/PG 10 x 120 H	4140.71060	16	–	–	120	–	–	325
BT 40/PG 10 x 160 H	4140.71080	16	–	–	160	–	–	325
BT 40/PG 10 x 220 XL	8841.71050	16	46	28	220	140	31	–
BT 40/PG 10 x 260 XL	8841.71090	16	46	28	260	140	31	–
BT 40/PG 10 x 300 XL	8841.71130	16	46	28	300	140	31	–
BT 40/PG 10 x 320 XL	8841.71150	16	46	28	320	240	31	–
BT 40/PG 10 x 360 XL	8841.71190	16	46	28	360	240	31	–
BT 40/PG 10 x 400 XL	8841.71230	16	46	28	400	240	31	–
BT 40/PG 15 x 075	2140.71530	24	–	–	75	–	–	–
BT 40/PG 15 x 080 H	4140.71540	24	–	–	80	–	–	285
BT 40/PG 15 x 120 H	4140.71560	24	–	–	120	–	–	325
BT 40/PG 15 x 160 H	4140.71580	24	–	–	160	–	–	325/285
BT 40/PG 15 x 220 XL	8841.73050	24	46	28	220	140	55	–
BT 40/PG 15 x 260 XL	8841.73090	24	46	28	260	140	55	–
BT 40/PG 15 x 300 XL	8841.73130	24	46	28	300	140	55	–
BT 40/PG 15 x 320 XL	8841.73150	24	46	28	320	240	55	–
BT 40/PG 15 x 360 XL	8841.73190	24	46	28	360	240	55	–
BT 40/PG 15 x 400 XL	8841.73230	24	46	28	400	240	55	–
BT 40/PG 25 x 080 H	4140.72540	40	–	–	80	–	–	405
BT 40/PG 25 x 120 H	4140.72560	40	–	–	120	–	–	405
BT 40/PG 25 x 160 H	4140.72580	40	–	–	160	–	–	405/405
BT 40/PG 25 x 226 XL	8841.76050	40	55	–	226	140	–	–
BT 40/PG 25 x 326 XL	8841.76150	40	55	–	326	240	–	–
BT 40/PG 32 x 086	2140.73240	50	–	–	86	–	–	–
BT-B 40								
BT-B 40/PG 10 x 080 H	4140.71043	16	–	–	80	–	–	285
BT-B 40/PG 10 x 120 H	4140.71063	16	–	–	120	–	–	325
BT-B 40/PG 10 x 160 H	4140.71083	16	–	–	160	–	–	325
BT-B 40/PG 15 x 075	2140.71533	24	–	–	75	–	–	–
BT-B 40/PG 15 x 080 H	4140.71543	24	–	–	80	–	–	285
BT-B 40/PG 15 x 120 H	4140.71563	24	–	–	120	–	–	325
BT-B 40/PG 15 x 160 H	4140.71583	24	–	–	160	–	–	325/285
BT-B 40/PG 25 x 080 H	4140.72543	40	–	–	80	–	–	405
BT-B 40/PG 25 x 120 H	4140.72563	40	–	–	120	–	–	405
BT-B 40/PG 25 x 160 H	4140.72583	40	–	–	160	–	–	405/405
BT-B 40/PG 32 x 086	2140.73243	50	–	–	86	–	–	–

*Balancing rings H: Ready to accept balancing rings

BT toolholders

BT

MAS 403

JIS B 6339

DIN ISO 7388-2

powRgrip®

Type	Part no.	Dimensions [mm]						Accessory
		D	D1	D2	L	L1	L2	FWR*
BT 50								
BT 50/PG 10 x 120 H	4150.71060	16	–	–	120	–	–	405
BT 50/PG 10 x 160 H	4150.71080	16	–	–	160	–	–	405
BT 50/PG 10 x 240 XL	8851.71070	16	46	28	240	140	31	–
BT 50/PG 10 x 260 XL	8851.71090	16	46	28	260	140	31	–
BT 50/PG 10 x 300 XL	8851.71130	16	46	28	300	140	31	–
BT 50/PG 10 x 340 XL	8851.71170	16	46	28	340	240	31	–
BT 50/PG 10 x 360 XL	8851.71190	16	46	28	360	240	31	–
BT 50/PG 10 x 400 XL	8851.71230	16	46	28	400	240	31	–
BT 50/PG 15 x 120 H	4150.71560	24	–	–	120	–	–	325
BT 50/PG 15 x 160 H	4150.71580	24	–	–	160	–	–	325
BT 50/PG 15 x 240 XL	8851.73070	24	46	28	240	140	55	–
BT 50/PG 15 x 260 XL	8851.73090	24	46	28	260	140	55	–
BT 50/PG 15 x 300 XL	8851.73130	24	46	28	300	140	55	–
BT 50/PG 15 x 340 XL	8851.73170	24	46	28	340	240	55	–
BT 50/PG 15 x 360 XL	8851.73190	24	46	28	360	240	55	–
BT 50/PG 15 x 400 XL	8851.73230	24	46	28	400	240	55	–
BT 50/PG 25 x 100	2150.72550	40	–	–	100	–	–	–
BT 50/PG 25 x 120 H	4150.72560	40	–	–	120	–	–	505
BT 50/PG 25 x 160 H	4150.72580	40	–	–	160	–	–	505 / 405
BT 50/PG 25 x 200 H	4150.72590	40	–	–	200	–	–	505 / 405
BT 50/PG 25 x 240 XL	8851.76070	40	55	–	240	140	–	–
BT 50/PG 25 x 340 XL	8851.76170	40	55	–	340	240	–	–
BT 50/PG 32 x 100	2150.73250	50	–	–	100	–	–	–
BT 50/PG 32 x 240 XL	8851.78070	50	58	–	240	140	–	–
BT 50/PG 32 x 340 XL	8851.78170	50	58	–	340	140	–	–

*Balancing rings H: Ready to accept balancing rings

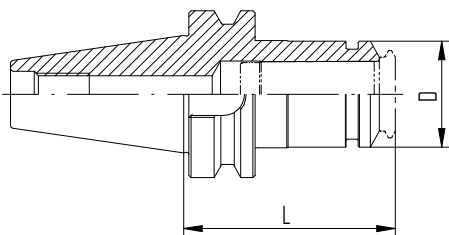

BT/PG

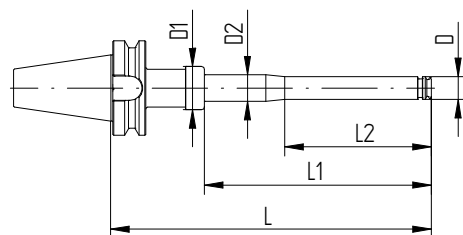

BT/PG XL

BT-OM toolholders

Type	Part no.	Dimensions [mm]				Accessory
		D	D1	L	L1	FWR*
BT-OM						
BT-OM 30/PG 10 x 062	2130.71028	16	–	62	–	–
BT-OM 30/PG 15 x 070 H	4130.71538	24	–	70	–	285
BT-OM 30/PG 25 x 080 H	4130.72548	40	–	80	–	405

*Balancing rings H: Ready to accept balancing rings

Information

BT-OM/PG toolholders without drive slots

Applications

This special toolholder without drive slots is designed for use on HAAS and HURCO CNC-machining centers, for High Speed Cutting (HSC) and High Performance Cutting (HPC). Use up to the max. power limit of the processing machine.

The anti-vibration characteristics of the BT-OM/PG toolholder reduce the wear of spindle and tool.

Balancing

REGO-FIX BT-OM/PG toolholders are balanced to G 2.5 @ 30,000 rpm / <1gmm. Type H toolholders are compatible with Hi-Q® balancing rings which allow precision balancing of the entire system including cutting tool up to 80,000 rpm depending on the balancing rings used.

Cooling options

PG standard collets for tools with an internal coolant supply (metallic sealed).
Coolant flush collets PG-CF for peripheral cooling.

Matched tooling system for best fit

For highest precision and best results the entire machining system counts. Therefore REGO-FIX components are carefully matched for optimum fit and accuracy. This guarantees the best runout and balance.

For the influence of runout on tool life, please refer to page 269.

Accessories are not included in delivery

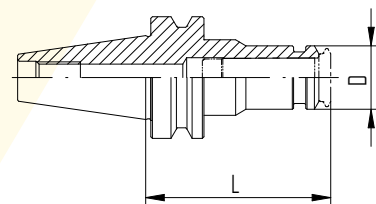

BT-OM/PG



10245

10245

10245

REGO-FIX BT+ dual contact toolholders

Key advantages

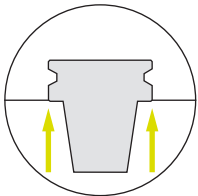

Higher toolholder stiffness due to taper (AT1) and face contact.

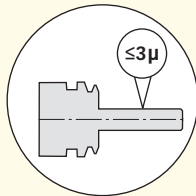

Total system runout TIR $\le 3\mu$ at 3xD.

Certified The BIG PLUS SYSTEM – licensed by BIG Daishowa – is manufactured at REGO-FIX in Switzerland under license according to BIG PLUS specifications.

Features and benefits

Total system runout TIR $\le 0.0001''$ (3 μ m)

Our holistic system consists of a powRgrip® toolholder and collet. All components together ensure best runout and accuracy.

Surface finish max. Ra 0.25

Achieve high clamping force and high transferable torque.

Balancing

100% balanced to G 2.5 @ 25,000 rpm / ≤ 1 gmm.

Hi-Q® balancing system

Ready to accept Hi-Q® balancing rings which allow for the offset of the imbalance introduced by the cutting tool up to 80,000 rpm depending on the balancing rings used. All collets with the additional type information "H" in the article name are designed for balancing rings.

Vibration dampening

Our holders offer excellent vibration dampening to sustain a high surface finish and can help prevent chatter.

Balancing specifications

BT+ 30	balanced to 30,000 rpm
BT+ 40	G 2.5 @ 25,000 rpm
BT+ 50	G 2.5 @ 25,000 rpm



Accessories are not included in delivery. Form B available on request

Type	Part no.	Dimensions [mm]		Accessory
		D	D1	FWR*
BT+ 30				
BT+ 30/PG 10 x 080 H	4130.71046	16	80	285
BT+ 30/PG 15 x 070 H	4130.71536	24	70	285
BT+ 30/PG 25 x 080 H	4130.72546	40	80	405
BT+ 30/PG 25 x 160 H	4130.72586	40	160	405/405
BT+ 40				
BT+ 40/PG 10 x 080 H	4140.71046	16	80	285
BT+ 40/PG 10 x 120 H	4140.71066	16	120	325
BT+ 40/PG 15 x 080 H	4140.71546	24	80	285
BT+ 40/PG 15 x 120 H	4140.71566	24	120	325
BT+ 40/PG 25 x 080 H	4140.72546	40	80	405
BT+ 40/PG 25 x 120 H	4140.72566	40	120	405
BT+ 40/PG 25 x 160 H	4140.72586	40	160	405/405
BT+ 50				
BT+ 50/PG 25 x 120 H	4150.72566	40	120	505
BT+ 50/PG 25 x 160 H	4150.72586	40	160	505/405

*Balancing rings H: Ready to accept balancing rings

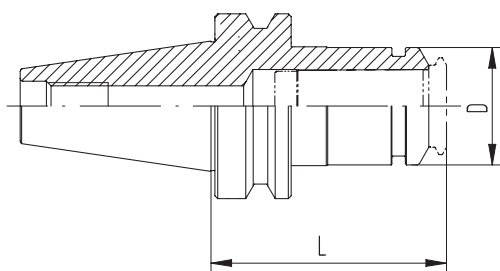

BT+/PG (A+AD)

CAT steep taper toolholders

Universally suitable for different machining applications.

ASME B5.50

Features and benefits

Total system runout TIR $\leq 0.0001''$ (3 μm)

Our holistic system consists of a powRgrip® toolholder and collet. All components together ensure best runout and accuracy.

Toolholder runout TIR $\leq 1 \mu\text{m}$

Measured from collet cavity to outer taper.

Taper accuracy AT3

Better spindle-to-holder fit and accuracy.

Surface finish max. Ra 0.25

Achieve high clamping force and high transferable torque.

Balancing

100% balanced to G 2.5 @ 25,000 rpm.

Balancing in XL toolholders

100% balanced to G 2.5 @ 5,000 rpm.

Hi-Q® balancing system

Ready to accept Hi-Q® balancing rings which allow for the offset of the imbalance introduced by the cutting tool up to 80,000 rpm depending on the balancing rings used. All toolholders with the additional type information "H" in the part number are designed for balancing rings.

Vibration dampening

Our holders offer excellent vibration dampening to sustain a high surface finish and can help prevent chatter.

ID chip hole

In accordance with DIN 69873 for 10 mm diameter.

Accessories are not included in delivery. Other XL sizes available on request



CAT toolholders

CAT
CAT-B
ASME B5.50

Type	Part no.	Dimensions						Accessory
		D [mm]	D1 [mm]	D2 [mm]	L [inch]	L1 [inch]	L2 [mm]	FWR*
CAT 40								
CAT 40/PG 6 x 3" H**	4340.70631	10	-	-	3"	-	-	285
CAT 40/PG 10 x 3.5" H	4340.71001	16	-	-	3.5"	-	-	285
CAT 40/PG 10 x 5" H	4340.71061	16	-	-	5"	-	-	285
CAT 40/PG 10 x 6" H	4340.71071	16	-	-	6"	-	-	285
CAT 40/PG 10 x 8" XL	8843.71031	16	42	28	8"	4"	31	-
CAT 40/PG 10 x 10" XL	8843.71081	16	42	28	10"	4"	31	-
CAT 40/PG 10 x 12" XL	8843.71131	16	42	28	12"	8"	31	-
CAT 40/PG 10 x 14" XL	8843.71181	16	42	28	14"	8"	31	-
CAT 40/PG 15 x 3.15" H	4340.71541	24	-	-	3.15"	-	-	285
CAT 40/PG 15 x 4" H	4340.71551	24	-	-	4"	-	-	285
CAT 40/PG 15 x 6" H	4340.71571	24	-	-	6"	-	-	325/285
CAT 40/PG 15 x 8" XL	8843.73031	24	42	28	8"	4"	55	-
CAT 40/PG 15 x 10" XL	8843.73081	24	42	28	10"	4"	55	-
CAT 40/PG 15 x 12" XL	8843.73131	24	42	28	12"	8"	55	-
CAT 40/PG 15 x 14" XL	8843.73181	24	42	28	14"	8"	55	-
CAT 40/PG 25 x 2.8"	2340.72531	40	-	-	2.8"	-	-	-
CAT 40/PG 25 x 3.15" H	4340.72541	40	-	-	3.15"	-	-	405
CAT 40/PG 25 x 4" H	4340.72551	40	-	-	4"	-	-	405
CAT 40/PG 25 x 6" H	4340.72571	40	-	-	6"	-	-	405/405
CAT 40/PG 25 x 8" H	4340.72591	40	52	-	8"	-	-	405/405
CAT 40/PG 25 x 10" XL	8843.76081	40	52	-	10"	4"	-	-
CAT 40/PG 25 x 14" XL	8843.76181	40	52	-	14"	8"	-	-
CAT 40/PG 32 x 3.5"	2340.73201	50	-	-	3.5"	-	-	-
CAT 40/PG 32 x 4.3" H	4340.73251	50	-	-	4.3"	-	-	505
CAT 40/PG 32 x 6" H	4340.73271	50	-	-	6"	-	-	505/505
CAT-B 40								
CAT-B 40/PG 10 x 3.5" H	4340.71004	16	-	-	3.5"	-	-	285
CAT-B 40/PG 10 x 6" H	4340.71074	16	-	-	6"	-	-	285
CAT-B 40/PG 15 x 3.15" H	4340.71544	24	-	-	3.15"	-	-	285
CAT-B 40/PG 15 x 4" H	4340.71554	24	-	-	4"	-	-	285
CAT-B 40/PG 15 x 6" H	4340.71574	24	-	-	6"	-	-	325/285
CAT-B 40/PG 25 x 2.8" **	2340.72534	40	-	-	2.8"	-	-	-
CAT-B 40/PG 25 x 3.15" H	4340.72544	40	-	-	3.15"	-	-	405
CAT-B 40/PG 25 x 4" H	4340.72554	40	-	-	4"	-	-	405
CAT-B 40/PG 25 x 6" H	4340.72574	40	-	-	6"	-	-	405/405
CAT-B 40/PG 32 x 4.3" H	4340.73254	50	-	-	4.3"	-	-	505
CAT-B 40/PG 32 x 6" H	4340.73274	50	-	-	6"	-	-	505/505

*Balancing rings H: Ready to accept balancing rings

**USA only

Type	Part no.	Dimensions						Accessory
		D [mm]	D1 [mm]	D2 [mm]	L [inch]	L1 [inch]	L2 [mm]	FWR*
CAT 50								
CAT 50/PG 10 x 4" H	4350.71051	16	-	-	4"	-	-	405
CAT 50/PG 10 x 8" XL	8853.71031	16	42	28	8"	4"	31	-
CAT 50/PG 10 x 10" XL	8853.71081	16	42	28	10"	4"	31	-
CAT 50/PG 10 x 12" XL	8853.71131	16	42	28	12"	8"	31	-
CAT 50/PG 10 x 14" XL	8853.71181	16	42	28	14"	8"	31	-
CAT 50/PG 15 x 4" H	4350.71551	24	-	-	4"	-	-	405
CAT 50/PG 15 x 8" XL	8853.73031	24	42	28	8"	4"	55	-
CAT 50/PG 15 x 10" XL	8853.73081	24	42	28	10"	4"	55	-
CAT 50/PG 15 x 12" XL	8853.73131	24	42	28	12"	8"	55	-
CAT 50/PG 15 x 14" XL	8853.73181	24	42	28	14"	8"	55	-
CAT 50/PG 25 x 4" H	4350.72551	40	-	-	4"	-	-	505
CAT 50/PG 25 x 6" H	4350.72571	40	-	-	6"	-	-	505 / 405
CAT 50/PG 25 x 8.3" XL**	8853.76041	40	52	-	8.3"	4"	-	-
CAT 50/PG 25 x 10" XL	8853.76081	40	52	-	10"	4"	-	-
CAT 50/PG 25 x 14" XL	8853.76181	40	52	-	14"	8"	-	-
CAT 50/PG 32 x 3.1" H	2350.73231	50	-	-	3.1"	-	-	-
CAT 50/PG 32 x 4.3" H	4350.73251	50	-	-	4.3"	-	-	505
CAT 50/PG 32 x 6" H	4350.73271	50	-	-	6"	-	-	505 / 505
CAT 50/PG 32 x 9.81" XL	8853.78071	50	58	-	9.81"	-	-	-
CAT 50/PG 32 x 11.51" XL	8853.78121	50	58	-	11.51"	-	-	-
CAT 50/PG 32 x 13.75" XL	8853.78171	50	58	-	13.75"	-	-	-
CAT 50/PG 32 x 15.45" XL	8853.78221	50	58	-	15.45"	-	-	-
CAT-B 50								
CAT-B 50/PG 25 x 4" H	4350.72554	40	-	-	4"	-	-	505
CAT-B 50/PG 25 x 6" H	4350.72574	40	-	-	6"	-	-	505 / 405
CAT-B 50/PG 32 x 4.3" H	4350.73254	50	-	-	4.3"	-	-	505
CAT-B 50/PG 32 x 6" H	4350.73274	50	-	-	6"	-	-	505 / 505

*Balancing rings H: Ready to accept balancing rings

**USA only

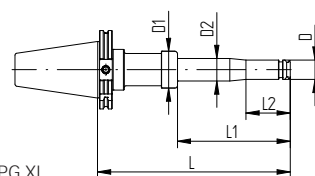
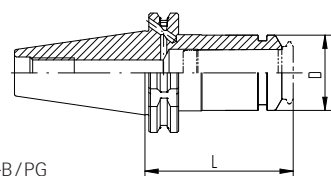
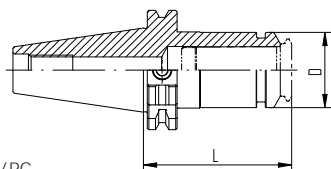

REGO-FIX CAT+ dual contact toolholders

Certified The BIG PLUS SYSTEM – licensed by BIG Daishowa – is manufactured at REGO-FIX in Switzerland under license according to BIG PLUS specifications.



Key advantages

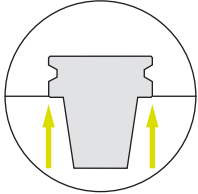

Higher toolholder stiffness due to taper (AT1) and face contact.

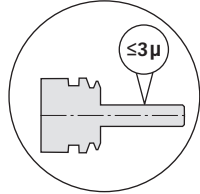

Total system runout TIR $\le 3\mu\text{m}$ at 3xD.

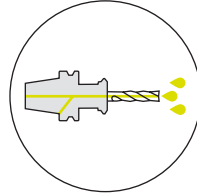

Form AD+B as standard configuration.

Type	Part no.	Dimensions						Accessory
		D [mm]	D1 [mm]	D2 [mm]	L [inch]	L1 [inch]	L2 [mm]	FWR*
CAT+ 40**								
CAT+ 40/PG 10 x 3.5" H	4340.71006	16	–	–	3.5"	–	–	285
CAT+ 40/PG 10 x 6" H	4340.71076	16	–	–	6"	–	–	285
CAT+ 40/PG 15 x 3.15" H	4340.71546	24	–	–	3.15"	–	–	285
CAT+ 40/PG 15 x 6" H	4340.71576	24	–	–	6"	–	–	325/285
CAT+ 40/PG 25 x 3.15" H	4340.72546	40	–	–	3.15"	–	–	405
CAT+ 40/PG 25 x 6" H	4340.72576	40	–	–	6"	–	–	405/405
CAT+ 40/PG 32 x 3.5"	2340.73206	50	–	–	3.5"	–	–	–
CAT+ 40/PG 32 x 6" H	4340.73276	50	–	–	6"	–	–	505/405
CAT+ 50**								
CAT+ 50/PG 10 x 4" H	4350.71056	16	–	–	4"	–	–	405
CAT+ 50/PG 15 x 4" H	4350.71556	24	–	–	4"	–	–	405
CAT+ 50/PG 15 x 6" H	4350.71576	24	–	–	6"	–	–	405
CAT+ 50/PG 25 x 4" H	4350.72556	40	–	–	4"	–	–	505
CAT+ 50/PG 25 x 6" H	4350.72576	40	–	–	6"	–	–	505/405
CAT+ 50/PG 32 x 4.3" H	4350.73256	50	–	–	4.3"	–	–	505
CAT+ 50/PG 32 x 6" H	4350.73276	50	–	–	6"	–	–	505/505

*Balancing rings H: Ready to accept balancing rings

**USA only

REGO-FIX CAPTO toolholders

These self-centering and balanced toolholders enable high-torque transmission and show a high-bending strength.

ISO 12164

Features and benefits

Total system runout TIR $\leq 3 \mu\text{m}$ @ 3xD

Our holistic system consists of a powRgrip® toolholder and collet. All components together ensure best runout and accuracy.

Toolholder runout TIR $\leq 1 \mu\text{m}$

Measured from collet cavity to outer taper.

Surface finish max. Ra 0.25

Achieve high clamping force and high transferable torque.

Balancing

100% balanced to G 2.5 @ 25,000 rpm / < 1gmm.

XL toolholders

Total system runout TIR $\leq 10 \mu\text{m}$
100% balanced to G 2.5 @ 5,000 rpm.

Hi-Q® balancing system

Ready to accept Hi-Q® balancing rings which allow for the offset of the imbalance introduced by the cutting tool up to 80,000 rpm depending on the balancing rings used. All toolholders with the additional type information "H" in the part number are designed for balancing rings.

Vibration dampening

Our holders offer excellent vibration dampening to sustain a high surface finish and can prevent cutting force alterations.

Certified REGO-FIX CAPTO – licensed by Sandvik Coromant – is manufactured at REGO-FIX Switzerland under license according to CAPTO specifications.



Accessories are not included in delivery. Other XL sizes available on request

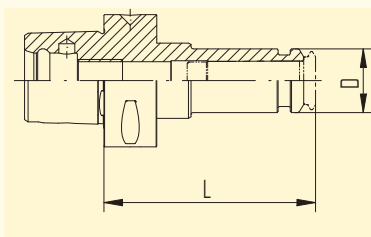

C/PG

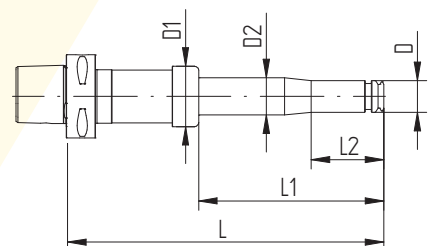

C/PG XL

Type	Part no.	Dimensions [mm]						Accessory
		D	D1	D2	L	L1	L2	FWR *
C3								
C3/PG 6 x 045	2803.70610	10	–	–	45	–	–	–
C3/PG 10 x 055	2803.71010	16	–	–	55	–	–	–
C3/PG 15 x 067	2803.71520	24	–	–	67	–	–	–
C4								
C4/PG 6 x 048	2804.70610	10	–	–	48	–	–	–
C4/PG 10 x 060	2804.71020	16	–	–	60	–	–	–
C4/PG 10 x 080 H	4804.71040	16	–	–	80	–	–	225
C4/PG 15 x 062	2804.71520	24	–	–	62	–	–	–
C4/PG 15 x 080 H	4804.71540	24	–	–	80	–	–	285
C5								
C5/PG 6 x 080 H	4805.70640	10	–	–	80	–	–	225
C5/PG 10 x 060	2805.71020	16	–	–	60	–	–	–
C5/PG 10 x 080 H	4805.71040	16	–	–	80	–	–	285
C5/PG 10 x 120 H	4805.71060	16	–	–	120	–	–	285
C5/PG 15 x 065	2805.71520	24	–	–	65	–	–	–
C5/PG 15 x 080 H	4805.71540	24	–	–	80	–	–	285
C5/PG 15 x 120 H	4805.71560	24	–	–	120	–	–	325
C5/PG 25 x 80	2805.72540	40	–	–	80	–	–	–
C5/PG 25 x 100 H	4805.72550	40	–	–	100	–	–	405
C6								
C6/PG 10 x 070	2806.71030	16	–	–	70	–	–	–
C6/PG 10 x 080 H	4806.71040	16	–	–	80	–	–	325
C6/PG 10 x 120 H	4806.71060	16	–	–	120	–	–	325
C6/PG 10 x 160 H	4806.71080	16	–	–	160	–	–	325
C6/PG 10 x 225 XL	8886.71050	16	46	28	225	140	31	–
C6/PG 10 x 240 XL	8886.71070	16	46	28	240	140	31	–
C6/PG 10 x 260 XL	8886.71090	16	46	28	260	140	31	–
C6/PG 10 x 300 XL	8886.71130	16	46	28	300	140	31	–
C6/PG 10 x 325 XL	8886.71150	16	46	28	325	240	31	–
C6/PG 10 x 340 XL	8886.71170	16	46	28	340	240	31	–
C6/PG 10 x 360 XL	8886.71190	16	46	28	360	240	31	–
C6/PG 10 x 400 XL	8886.71230	16	46	28	400	240	31	–

*Balancing rings H: Ready to accept balancing rings

All REGO-FIX CAPTO holders are also available with an ID chip hole on request

Type	Part no.	Dimensions [mm]						Accessory
		D	D1	D2	L	L1	L2	FWR *
C6/PG 15 x 071	2806.71530	24	–	–	71	–	–	–
C6/PG 15 x 080 H	4806.71540	24	–	–	80	–	–	325
C6/PG 15 x 120 H	4806.71560	24	–	–	120	–	–	325
C6/PG 15 x 160 H	4806.71580	24	–	–	160	–	–	325
C6/PG 15 x 225 XL	8886.73050	24	46	28	225	140	55	–
C6/PG 15 x 240 XL	8886.73070	24	46	28	240	140	55	–
C6/PG 15 x 260 XL	8886.73090	24	46	28	260	140	55	–
C6/PG 15 x 300 XL	8886.73130	24	46	28	300	140	55	–
C6/PG 15 x 325 XL	8886.73150	24	46	28	325	240	55	–
C6/PG 15 x 340 XL	8886.73170	24	46	28	340	240	55	–
C6/PG 15 x 360 XL	8886.73190	24	46	28	360	240	55	–
C6/PG 15 x 400 XL	8886.73230	24	46	28	400	240	55	–
C6/PG 25 x 085	2806.72540	40	–	–	85	–	–	–
C6/PG 25 x 100 H	4806.72550	40	–	–	100	–	–	405
C6/PG 25 x 120 H	4806.72560	40	–	–	120	–	–	405
C6/PG 25 x 160 H	4806.72580	40	–	–	160	–	–	405
C6/PG 25 x 230 XL	8886.76060	40	55	–	230	140	–	–
C6/PG 25 x 330 XL	8886.76160	40	55	–	330	240	–	–
C6/PG 32 x 090	2806.73240	50	–	–	90	–	–	–
C6/PG 32 x 230 XL	8886.78060	50	55	–	230	140	–	–
C6/PG 32 x 330 XL	8886.78160	50	55	–	330	240	–	–

C8

C8/PG 10 x 232 XL	8888.71060	16	46	28	232	0.25 Pt	31	–
C8/PG 10 x 332 XL	8888.71160	16	46	28	332	240	31	–
C8/PG 15 x 232 XL	8888.73060	24	46	28	232	140	55	–
C8/PG 15 x 332 XL	8888.73160	24	46	28	332	240	55	–
C8/PG 25 x 092	2808.72540	40	–	–	92	–	–	–
C8/PG 25 x 230 XL	8888.76060	40	55	–	230	140	–	–
C8/PG 25 x 330 XL	8888.76160	40	55	–	330	240	–	–
C8/PG 32 x 090	2808.73240	50	–	–	90	–	–	–
C8/PG 32 x 230 XL	8888.78060	50	55	–	230	140	–	–
C8/PG 32 x 330 XL	8888.78160	50	55	–	330	240	–	–

*Balancing rings H: Ready to accept balancing rings

All REGO-FIX CAPTO holders are also available with an ID chip hole on request

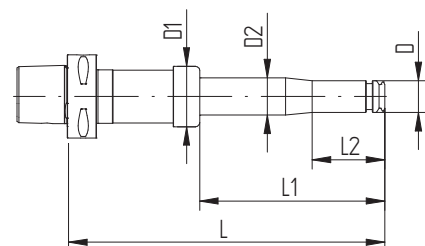
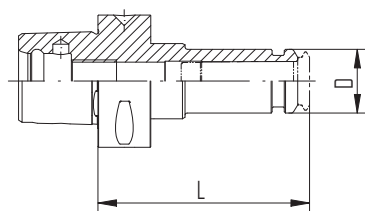

ISO 20 toolholder



Applications The REGO-FIX ISO 20 toolholders are designed to work with the HAAS Office Mill. To utilize the full potential of your machine, use the REGO-FIX brand of holders and collets to see the difference quality can achieve in your machining operations.

Balancing

// 100% balanced to 50,000 rpm.

Matched tooling system for best fit For highest precision and best results the whole system counts. Therefore REGO-FIX components are carefully matched for optimum fit and accuracy. This guarantees the best runout and balance.

More information about the influence of TIR on tool life see page 269.

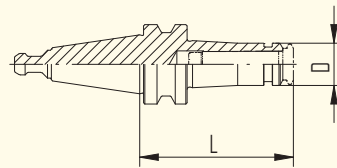

ISO/PG

Type	Part no.	Dimensions [mm]	
		D	L
ISO			
ISO 20/PG 6 x 075 HAAS*	8020.24207	10	75
ISO 20/PG 10 x 058 HAAS	2420.71015	16	58

*USA only

Cylindrical shank toolholders CYL

CYL

Features and benefits

Total system runout TIR $\leq 3 \mu\text{m}$ @ 3xD

Our holistic system consists of a powRgrip® toolholder and collet. All components together ensure best runout and accuracy.

Toolholder runout TIR $\leq 1 \mu\text{m}$

Measured from collet cavity to outer shank.

Surface finish max. Ra 0.25

Achieve high clamping force and high transferable torque.

Minimal outside dimensions

Slim design provides more machining flexibility.

Extra length possible

CYL 10/PG and CYL 20/PG can be used as extensions.

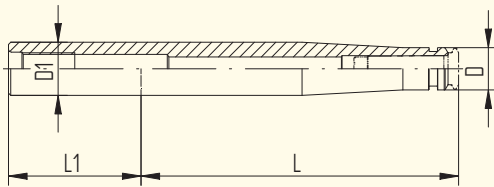

Drawing 1

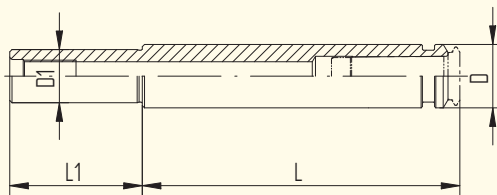

Drawing 2

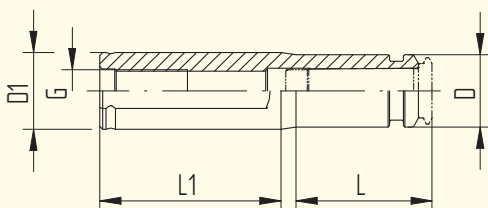

Drawing 3

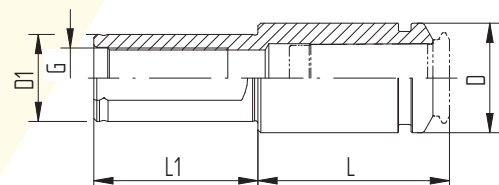

Drawing 4

CYL toolholders

CYL

CYL-T

CYL-T toolholders (for turning applications)

Type	Part no.	Dimensions [mm]					G	Drawing
		D	L	L1	D1 h6			
CYL 10								
CYL 10/PG 6 x 120	2610.70620	10	120	30	10	M 5	1	
CYL 10/PG 10 x 120	2610.71020	16	120	40	10	M 5	2	
CYL 20								
CYL 20/PG 10 x 120	2620.71020	16	120	50	20	M 12 x 1	1	
CYL 20/PG 10 x 160	2620.71040	16	160	50	20	M 12 x 1	1	
CYL 20/PG 10 x 200	2620.71060	16	200	50	20	M 12 x 1	1	
CYL 20/PG 15 x 120	2620.71520	24	120	50	20	M 12 x 1	1	
CYL 25								
CYL 25/PG 15 x 160	2625.71540	24	160	56	25	M 12 x 1	1	
CYL 25/PG 25 x 80*	8020.25080	40	80	56	25	M 12 x 1	4	
CYL 25/PG 25 x 100*	8020.25100	40	100	56	25	M 12 x 1	4	
CYL 25/PG 25 x 120*	8020.25120	40	120	56	25	M 12 x 1	4	
<i>*USA only</i>								
CYL-T 25								
CYL-T 25/PG 15 x 045	2625.71522	24	45	60	25	M 14 x 1	3	
CYL-T 1"								
CYL-T 1"/PG 15 x 045	2625.71523	24	45	60	25.4	M 14 x 1	3	
CYL-T 1 1/4"								
CYL-T 1 1/4"/PG 15 x 045	2631.71523	24	45	60	31.75	M 14 x 1	3	
CYL-T 1 1/4"/PG 25 x 070	2631.72543	40	70	60	31.75	M 22 x 1.5	4	
CYL-T 32								
CYL-T 32/PG 15 x 045	2632.71522	24	45	60	32	M 14 x 1	4	
CYL-T 32/PG 25 x 070	2632.72542	40	70	60	32	M 22 x 1.5	4	
CYL-T 1 1/2"								
CYL-T 1 1/2"/PG 15 x 050	2638.71523	24	50	60	38.1	M 14 x 1	3	
CYL-T 1 1/2"/PG 25 x 065	2638.72543	40	65	60	38.1	M 22 x 1.5	4	
CYL-T 40								
CYL-T 40/PG 15 x 050	2640.71522	24	50	60	40	M 14 x 1	3	
CYL-T 40/PG 25 x 065	2640.72542	40	65	60	40	M 22 x 1.5	5	

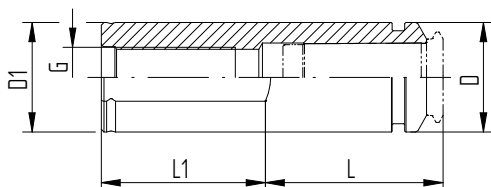

Drawing 5

Form-fit for 100% pullout protection

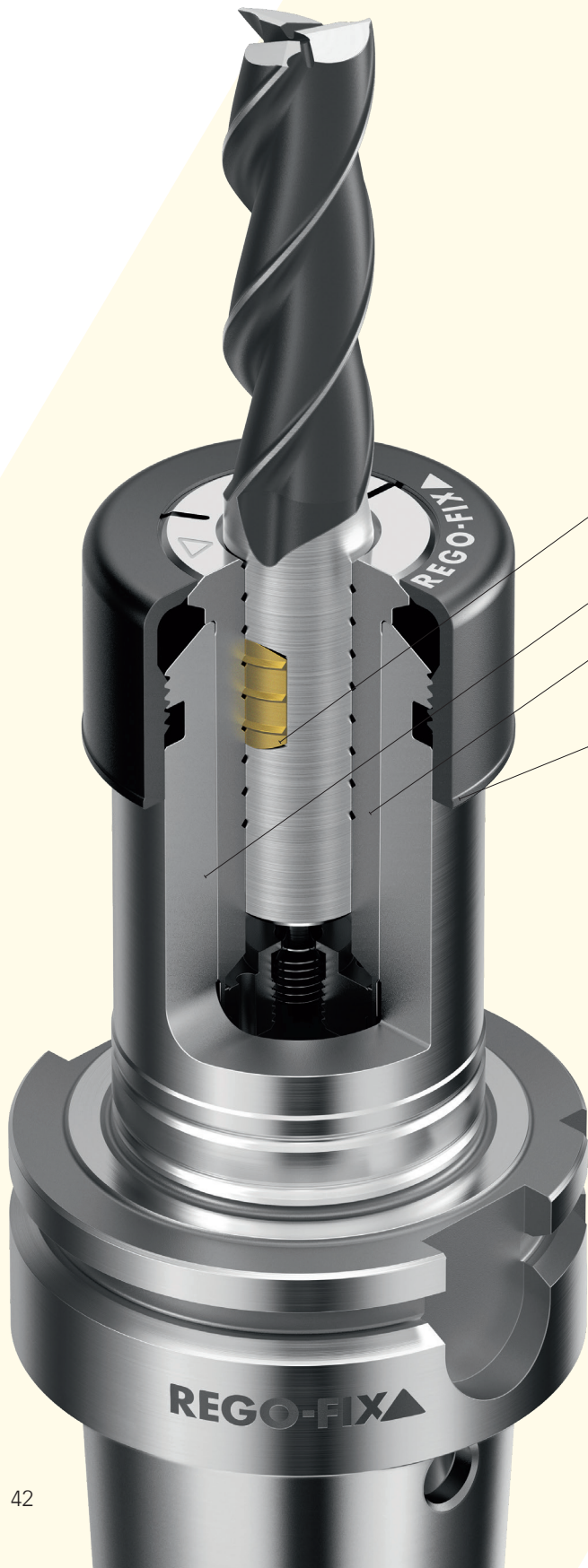

Form and force-fitting clamping system Tools and collets are 100% secured against tool pull-out, making secuRgrip® your safety net for successful machining. In high performance cutting (HPC), the tool can pull out of the clamping system during the milling operation and damage the workpiece. We developed the secuRgrip® locking system for operators who want to avoid any pull-out.

Process security Optimize your machining productivity by securing your processes.

Our secuRgrip® solution fits all standard tools with endmill flat according to DIN 6535-HB (metric). This means that no special tool shank form is required.

secuRgrip® system elements

- // secuRgrip® threaded insert
For all shanks with Weldon surface
- // secuRgrip® toolholder with thread
- // secuRgrip® PG 15-SG, PG 25-SG or PG 32-SG collet
For all secuRgrip® collet part numbers, please refer to page 61.
- // secuRgrip® safety nut

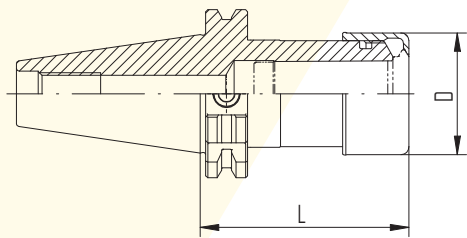

PG-SG

Expert advice

Freewheel wrench head, grip bar or torque wrench are required to safely fasten the nut.

For all secuRgrip® accessories part numbers, please refer to page 258.

Type	Part no.	Dimensions [mm]		Accessory
		D	L	FWR*
SK/PG-SG				
SK 40/PG 25-SG x 080 H	5240.72540	46	80	405
SK 40/PG 25-SG x 120 H	5240.72560	46	120	405
SK 40/PG 25-SG x 160 H	5240.72580	46	160	405/405
SK 40/PG 32-SG x 080	5240.73240	55	80	–
SK 50/PG 32-SG x 080	5250.73240	55	80	–
BT/PG-SG				
BT 40/PG 25-SG x 080 H	5140.72540	46	80	405
BT 40/PG 25-SG x 120 H	5140.72560	46	120	405
BT 40/PG 32-SG x 086	5140.73240	55	86	–
BT 50/PG 25-SG x 100	5150.72550	46	100	–
BT 50/PG 25-SG x 120 H	5150.72560	46	120	505
BT 50/PG 32-SG x 100	5150.73250	55	100	–
BT+/PG-SG				
BT+ 50/PG 25-SG x 120 H	5150.72566	46	120	505
HSK/PG-SG				
HSK-A 63/PG 25-SG x 100 H	5563.72550	46	100	405
HSK-A 63/PG 25-SG x 120 H	5563.72560	46	120	405
HSK-A 63/PG 25-SG x 160 H	5563.72580	46	160	405/405
HSK-A 63/PG 25-SG x 200 H	5563.72590	46	200	405/405
HSK-A 63/PG 32-SG x 100	5563.73250	55	100	–
HSK-A 63/PG 32-SG x 120 H	5563.73260	55	120	505
HSK-A 80/PG 32-SG x 105 H	5580.73250	55	105	505
HSK-A 100/PG 25-SG x 100 H	5500.72550	46	100	505
HSK-A 100/PG 25-SG x 160 H	5500.72580	46	160	505/405
HSK-A 100/PG 25-SG x 200 H	5500.72590	46	200	505/405
HSK-A 100/PG 32-SG x 106 H	5500.73250	55	106	505
HSK-A 100/PG 32-SG x 160 H	5500.73280	55	160	505
HSK-A 100/PG 32-SG x 200 H	5500.73290	55	200	505/505
C/PG-SG				
C6/PG 25-SG x 100	5806.72550	46	100	–
C6/PG 32-SG x 090	5806.73240	55	90	–
C8/PG 25-SG x 092	5808.72540	46	92	–
C8/PG 32-SG x 090	5808.73240	55	90	–

*Balancing rings H: Ready to accept balancing rings

Included in delivery: secuRgrip® toolholder with secuRgrip® safety nut

Additional lengths and interfaces available on request

Type	Part no.	Dimensions [mm]		Accessory
		D	L	FWR*
CAT/PG-SG**				
CAT 40/PG 25-SG x 2.8"	5340.72531	46	2.8"	–
CAT 40/PG 25-SG x 3.15" H	5340.72541	46	3.15"	405
CAT 40/PG 25-SG x 4" H	5340.72551	46	4"	405
CAT 40/PG 25-SG x 6" H	5340.72571	46	6"	405/405
CAT 40/PG 32-SG x 3.5"	5340.73201	55	3.5"	–
CAT 40/PG 32-SG x 4.3" H	5340.73251	55	4.3"	505
CAT 40/PG 32-SG x 6" H	5340.73271	55	6"	505/505
CAT 50/PG 25-SG x 4" H	5350.72551	46	4"	405
CAT 50/PG 25-SG x 6" H	5350.72571	46	6"	405/405
CAT 50/PG 32-SG x 3.1" H	5350.73231	55	3.1"	505
CAT 50/PG 32-SG x 4.3" H	5350.73251	55	4.3"	505
CAT 50/PG 32-SG x 6" H	5350.73271	55	6"	505/505
CAT-B/PG-SG**				
CAT-B 40/PG 25-SG x 3.15" H	5340.72544	46	3.15"	405
CAT-B 40/PG 25-SG x 4" H	5340.72554	46	4"	405
CAT-B 40/PG 25-SG x 6" H	5340.72574	46	6"	405/405
CAT-B 40/PG 32-SG x 4.3" H	5340.73254	55	4.3"	505
CAT-B 40/PG 32-SG x 6" H	5340.73274	55	6"	505/505
CAT-B 50/PG 25-SG x 4" H	5350.72554	46	4"	405
CAT-B 50/PG 25-SG x 6" H	5350.72574	46	6"	405/405
CAT-B 50/PG 32-SG x 4.3" H	5350.73254	55	4.3"	505
CAT-B 50/PG 32-SG x 6" H	5350.73274	55	6"	505/505
CAT+/PG-SG**				
CAT+ 40/PG 25-SG x 3.15" H	5340.72546	46	3.15"	405
CAT+ 40/PG 25-SG x 6" H	5340.72576	46	6"	405/405
CAT+ 40/PG 32-SG x 3.5"	5340.73206	55	3.5"	–
CAT+ 40/PG 32-SG x 6" H	5340.73276	55	6"	505/505
CAT+ 50/PG 25-SG x 4" H	5350.72556	46	4"	405
CAT+ 50/PG 25-SG x 6" H	5350.72576	46	6"	405/405
CAT+ 50/PG 32-SG x 4.3" H	5350.73256	55	4.3"	505
CAT+ 50/PG 32-SG x 6" H	5350.73276	55	6"	505/505

*Balancing rings H: Ready to accept balancing rings

**USA only

Included in delivery: secuRgrip® toolholder with secuRgrip® safety nut

Additional lengths and interfaces available on request

Heavy Duty secuRgrip® Toolholders

PG-HD-SG

powRgrip®

PG HD-SG Holders Heavy Duty secuRgrip® toolholders are up to two times more rigid than standard holders. They include secuRgrip® safety nut for 100% protection against tool pullout.

Features

- // Includes secuRgrip® design to prevent pullout
- // Most designs retain the use of balance rings
- // Fits existing powRgrip® clamping units

Key Advantages

- // Up to 2 times more rigid than standard holders
- // Increases feed rates to maximize tooling efficiency
- // Better surface finish with less deflection



Type	Part no.	Dimensions [mm]		Accessory
		D	L	FWR*
HSK-A/PG HD-SG				
HSK-A 63/PG 25 HD-SG x 100 H	5563.82550	46	100	405
HSK-A 100/PG 25 HD-SG x 100 H	5500.82550	46	100	405
HSK-A 100/PG 32 HD-SG x 106 H	5500.83250	55	106	505
HSK-A 125/PG 25 HD-SG x 105 H	5502.82550	46	105	405
HSK-A 125/PG 32 HD-SG x 112 H	5502.83250	55	112	505
HSK-FP 80				
HSK-FP 80/PG 25 HD-SG x 085 H K	8070.80250	40	85	405
HSK-FP 80/PG 32 HD-SG x 095 H	8070.80320	50	95	505
CAT/PG HD-SG**				
CAT 50/PG 25 HD-SG x 6" H	5350.82571	46	6"	405
CAT 50/PG 32 HD-SG x 4.3" H	5350.83251	55	4.3"	505
CAT 50/PG 32 HD-SG x 6" H	5350.83271	55	6"	505

*Balancing rings H: Ready to accept balancing rings

**USA only

PG thread-cutting solutions

CYL SSY/HSK-A SSY Softsynchro® tapping holder

- // With **minimum length compensation**
- // Eliminates small synchronization errors of machines (Rigid Tapping)

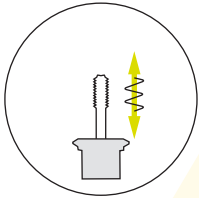

Applications

- // Machines for direct thread cutting
- // For all tapping tools with h9 shanks
- // The turning movement of the spindles can be offset with the feed axis and thus synchronized
- // Synchronization errors are created by the dynamics of the spindle and linear drives. The tapping holder is equipped with the minimum length compensation and compensates the synchronization errors
- // Depending on the application, the service life for the customer can be increased by up to 150%
- // Guides coolant with up to 50 bar / 725 PSI of pressure to the tap, without compromising length compensation

Comparative axial force testing

Occurring axial forces with thread forms M10 in St37, Speed 500 rpm.
Source: In-house testing

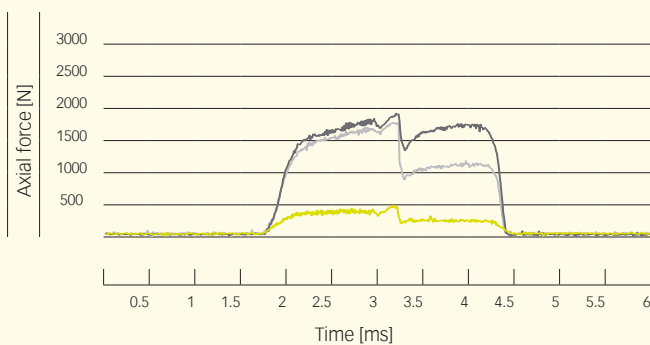

Summary The axial forces increase with increasing speed. With a rigid toolholder, the forces occurring when forming threads are considerably higher than with the Softsynchro® tapping holder. This allows for the optimum use of the synchronous spindle with the best possible service life and thread surface quality.

CYL GSF tapping holder

- // With **length compensation**
- // Used on machines in which the feed movement is not synchronized with the thread pitch during processing

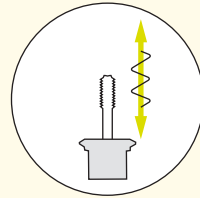

Applications

- // For machines without a tapping option
- // Ensures the compensation of differences between the thread pitch and spindle feed
- // Features a pressure-point mechanism
- // Safe tap cutting
- // Uniform, reproducible thread depths
- // Guides coolant with up to 50 bar / 725 PSI of pressure to the tap, without compromising length compensation
- // Universal use thanks to its compact design and low gauge length

Comparative axial force testing

Occurring axial forces with thread forms M10 in St37, Speed 2.000 rpm.
Source: In-house testing

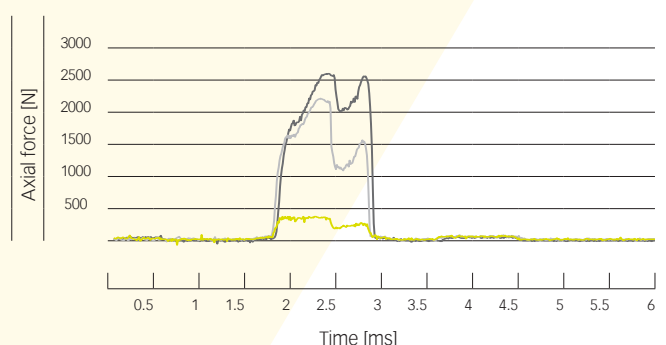

- REGO-FIX Softsynchro® tapping holders
- Competitor synchronous toolholder
- Rigid synchronous toolholder

PG tapping holders

HSK-A SSY

69893-A

ISO 12164

CYL SSY

DIN 1835 B+E

CYL GSF

DIN 1835 B+E

Type	Part no.	Dimensions [mm]		Compression	Tension
		D	L	[mm]	[mm]
HSK-A SSY					
HSK-A 63 SSY / PG 15	2563.61507	24	114.5	0.5	0.5
HSK-A 63 SSY / PG 25	2563.62507	40	131	0.5	0.5

For tapping collets, please refer to page 62

Type	Part no.	Dimensions [mm]				Compression	Tension
		D	D1	L	L1	[mm]	[mm]
CYL SSY							
CYL 25 SSY / PG 15	2625.61507	24	25	92	57	0.5	0.5
CYL 25 SSY / PG 25	2625.62507	40	25	109.5	57	0.5	0.5

For tapping collets, please refer to page 62

Type	Part no.	Dimensions [mm]				Compression	Tension
		D	D1	L	L1	[mm]	[mm]
CYL GSF							
CYL 25 GSF / PG 15	2625.61508	24	25	99.5	57	5	7.5
CYL 25 GSF / PG 25	2625.62508	40	25	134	57	7	10

For tapping collets, please refer to page 62

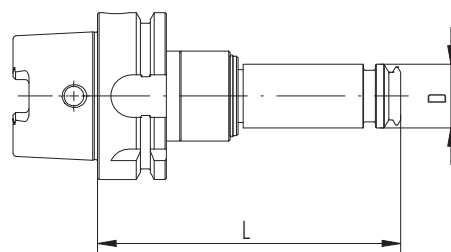



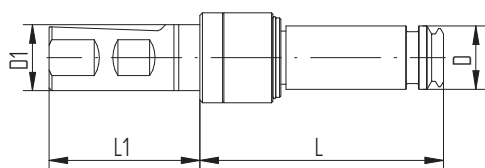



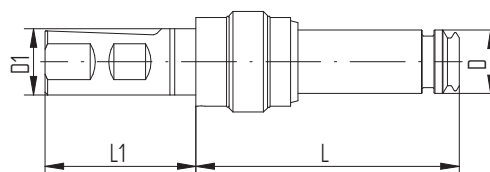

HSK-A 63 SSY / PG



CYL 25 SSY / PG



CYL 25 GSF / PG

Micro machining	Standard	Cooling	Long shanks	Short shanks	Turning collets	Pullout protection secuRgrip®	Collets for tapping
PG-MB	PG	PG-CF	PG-L	PG-S	PG-T	PG-SG	PG-TAP
							
page 50	page 51	page 54	page 57	page 58	page 60	page 61	page 62



powRgrip® collets in Swiss quality



	MB	Std.	CF	L	S	T	SG	TAP	MQL*
	micro-bore	standard	coolant flush	long	short	turning applications	secuRgrip®	tapping collet	minimum quantity lubrication
Main machining use	micro-machining	general machining	peripheral cooling	longer than DIN 6535	shorter than DIN 6535	turning	heavy machining	rigid tapping	milling
PG size	6–10	6–32	6–32	15–32	10–32	15–25	15–32	15–25	15–32
Shaft diameter range	0.2–1.5	2–25.4	2–25.4	4–25.4	3–25.4	5–20	10–25.4	3.5–16	5–25.4
Shaft tolerance	h6	h6	h6	h6	h6	h6	h6	h9	h6
For tools with internal coolant supply	–	•	–	•	•	•	•	•	•
Metallic sealed	–	•	–	•	•	•	•	•	•
Internal square	–	–	–	–	–	–	–	•	–
secuRgrip® thread to prevent tool pullout	–	–	–	–	–	–	•	–	–
Technical illustration of cooling	–								
Warranty	5 Years	5 Years	5 Years	5 Years	5 Years	5 Years	5 Years	5 Years	5 Years
	20,000 Cycles	20,000 Cycles	20,000 Cycles	20,000 Cycles	20,000 Cycles	20,000 Cycles	20,000 Cycles	20,000 Cycles	20,000 Cycles
Additional features	Length can be pre-adjusted with VEV	Length can be pre-adjusted with VEV	Length can be pre-adjusted with VEV	Without stop screw	Length can be pre-adjusted with VEV	With adjustable sidescrew	For all tools with endmill flat as per DIN 535-HB	Length can be pre-adjusted with VEV	for MQL

*MQL and CRYO-compatible collets available on request

Type	Part no.	Ø		
		[mm]	[decimal inch]	[inch]
PG 6-MB [mm]				
Ø 0.2 mm	1706.00209	0.2	0.0079	–
Ø 0.3 mm	1706.00309	0.3	0.0118	–
Ø 0.4 mm	1706.00409	0.4	0.0157	–
Ø 0.5 mm	1706.00509	0.5	0.0197	–
Ø 0.6 mm	1706.00609	0.6	0.0236	–
Ø 0.7 mm	1706.00709	0.7	0.0276	–
Ø 0.8 mm	1706.00809	0.8	0.0315	–
Ø 0.9 mm	1706.00909	0.9	0.0354	–
Ø 1.0 mm	1706.01009	1.0	0.0394	–
Ø 1.5 mm	1706.01509	1.5	0.0591	–

PG 6-MB [inch]				
Ø 1/16"	1706.01599	1.5875	0.0625	1/16"

PG 10-MB [mm]				
Ø 0.2 mm	1710.00209	0.2	0.0079	–
Ø 0.3 mm	1710.00309	0.3	0.0118	–
Ø 0.4 mm	1710.00409	0.4	0.0157	–
Ø 0.5 mm	1710.00509	0.5	0.0197	–
Ø 0.6 mm	1710.00609	0.6	0.0236	–
Ø 0.7 mm	1710.00709	0.7	0.0276	–
Ø 0.8 mm	1710.00809	0.8	0.0315	–
Ø 0.9 mm	1710.00909	0.9	0.0354	–
Ø 1.0 mm	1710.01009	1.0	0.0394	–
Ø 1.5 mm	1710.01509	1.5	0.0591	–

PG 10-MB [inch]				
Ø 1/16"	1710.01589	1.5875	0.0625	1/16"



PG standard collets

PG Std.

Type	Part no.	Ø		
		[mm]	[decimal inch]	[inch]
PG 6 [mm]				
Ø 2.0 mm	1706.02000	2.0	0.0787	–
Ø 2.5 mm	1706.02500	2.5	0.0984	–
Ø 3.0 mm	1706.03000	3.0	0.1181	–
Ø 4.0 mm	1706.04000	4.0	0.1574	–

PG 6 [inch]				
Ø 1/8"	1706.03181	3.175	0.125	1/8"

PG 10 [mm]				
Ø 2.0 mm	1710.02000	2.0	0.0787	–
Ø 2.5 mm	1710.02500	2.5	0.0984	–
Ø 3.0 mm	1710.03000	3.0	0.1181	–
Ø 3.5 mm	1710.03500	3.5	0.1378	–
Ø 4.0 mm	1710.04000	4.0	0.1575	–
Ø 4.5 mm	1710.04500	4.5	0.1772	–
Ø 5.0 mm	1710.05000	5.0	0.1969	–
Ø 5.5 mm	1710.05500	5.5	0.2165	–
Ø 6.0 mm	1710.06000	6.0	0.2362	–

PG 10 [inch]				
Ø 1/8"	1710.03181	3.175	0.125	1/8"
Ø 3/16"	1710.04761	4.763	0.1875	3/16"
Ø 1/4"	1710.06351	6.35	0.25	1/4"

PG 15 [mm]				
Ø 3.0 mm	1715.03000	3.0	0.1181	–
Ø 3.5 mm	1715.03500	3.5	0.1378	–
Ø 4.0 mm	1715.04000	4.0	0.1575	–
Ø 4.5 mm	1715.04500	4.5	0.1772	–
Ø 5.0 mm	1715.05000	5.0	0.1969	–
Ø 5.5 mm	1715.05500	5.5	0.2165	–
Ø 6.0 mm	1715.06000	6.0	0.2362	–
Ø 7.0 mm	1715.07000	7.0	0.2756	–
Ø 8.0 mm	1715.08000	8.0	0.315	–
Ø 9.0 mm	1715.09000	9.0	0.3543	–
Ø 10.0 mm	1715.10000	10.0	0.3937	–

PG 15-TW [mm]				
PG 15-TW Ø 12.00	1715.12006	12.0	0.4724	–

TW: Thin-wall collets are guaranteed 1 year or 2000 clamping cycles

Type	Part no.	Ø		
		[mm]	[decimal inch]	[inch]
PG 15 [inch]				
Ø 1/8"	1715.03181	3.175	0.125	1/8"
Ø 3/16"	1715.04761	4.763	0.1875	3/16"
Ø 1/4"	1715.06351	6.35	0.25	1/4"
Ø 5/16"	1715.07941	7.938	0.3125	5/16"
Ø 3/8"	1715.09521	9.525	0.375	3/8"

PG 15-TW [inch]				
PG 15-TW Ø 1/2"	1715.12706	12.7	0.5	1/2"

TW: Thin-wall collets are guaranteed 1 year or 500 clamping cycles

PG 25 [mm]				
Ø 3.0 mm	1725.03000	3.0	0.1181	–
Ø 3.5 mm	1725.03500	3.5	0.1378	–
Ø 4.0 mm	1725.04000	4.0	0.1575	–
Ø 4.5 mm	1725.04500	4.5	0.1772	–
Ø 5.0 mm	1725.05000	5.0	0.1969	–
Ø 5.5 mm	1725.05500	5.5	0.2165	–
Ø 6.0 mm	1725.06000	6.0	0.2362	–
Ø 7.0 mm	1725.07000	7.0	0.2756	–
Ø 8.0 mm	1725.08000	8.0	0.315	–
Ø 9.0 mm	1725.09000	9.0	0.3543	–
Ø 10.0 mm	1725.10000	10.0	0.3937	–
Ø 11.0 mm	1725.11000	11.0	0.4331	–
Ø 12.0 mm	1725.12000	12.0	0.4724	–
Ø 13.0 mm	1725.13000	13.0	0.5118	–
Ø 14.0 mm	1725.14000	14.0	0.5512	–
Ø 15.0 mm	1725.15000	15.0	0.5906	–
Ø 16.0 mm	1725.16000	16.0	0.63	–
Ø 18.0 mm	1725.18000	18.0	0.7087	–
Ø 20.0 mm	1725.20000	20.0	0.7874	–

PG 25 [inch]				
Ø 1/8"	1725.03181	3.175	0.125	1/8"
Ø 3/16"	1725.04761	4.763	0.1875	3/16"
Ø 1/4"	1725.06351	6.35	0.25	1/4"
Ø 5/16"	1725.07941	7.938	0.3125	5/16"
Ø 3/8"	1725.09521	9.525	0.375	3/8"
Ø 7/16"	1725.11111	11.113	0.4375	7/16"
Ø 1/2"	1725.12701	12.7	0.5	1/2"
Ø 9/16"	1725.14291	14.288	0.5625	9/16"
Ø 5/8"	1725.15881	15.875	0.625	5/8"
Ø 3/4"	1725.19051	19.05	0.75	3/4"

PG standard collets

PG Std.

Type	Part no.	Ø		
		[mm]	[decimal inch]	[inch]
PG 32 [mm]				
Ø 6.0 mm	1732.06000	6.0	0.2362	–
Ø 7.0 mm	1732.07000	7.0	0.2756	–
Ø 8.0 mm	1732.08000	8.0	0.315	–
Ø 9.0 mm	1732.09000	9.0	0.3543	–
Ø 10.0 mm	1732.10000	10.0	0.3937	–
Ø 11.0 mm	1732.11000	11.0	0.4331	–
Ø 12.0 mm	1732.12000	12.0	0.4724	–
Ø 14.0 mm	1732.14000	14.0	0.5512	–
Ø 16.0 mm	1732.16000	16.0	0.63	–
Ø 18.0 mm	1732.18000	18.0	0.7087	–
Ø 20.0 mm	1732.20000	20.0	0.7874	–
Ø 22.0 mm	1732.22000	22.0	0.8661	–
Ø 25.0 mm	1732.25000	25.0	0.9843	–

PG 32 [inch]				
Ø 1/4"	1732.06351	6.35	0.25	1/4"
Ø 5/16"	1732.07941	7.938	0.3125	5/16"
Ø 3/8"	1732.09521	9.525	0.375	3/8"
Ø 7/16"	1732.11111	11.113	0.4375	7/16"
Ø 1/2"	1732.12701	12.7	0.5	1/2"
Ø 9/16"	1732.14291	14.288	0.5625	9/16"
Ø 5/8"	1732.15881	15.875	0.625	5/8"
Ø 3/4"	1732.19051	19.05	0.75	3/4"
Ø 7/8"	1732.22231	22.225	0.875	7/8"
Ø 1"	1732.25401	25.4	1.0	1"



Type	Part no.	Ø		
		[mm]	[decimal inch]	[inch]
PG 6-CF [mm]				
Ø 2.0 mm	1706.02002	2.0	0.0787	–
Ø 3.0 mm	1706.03002	3.0	0.1181	–
PG 6-CF [inch]				
Ø 1/8"	1706.03183	3.175	0.125	1/8"
PG 10-CF [mm]				
Ø 2.0 mm	1710.02002	2.0	0.0787	–
Ø 2.5 mm	1710.02502	2.5	0.0984	–
Ø 3.0 mm	1710.03002	3.0	0.1181	–
Ø 4.0 mm	1710.04002	4.0	0.1575	–
Ø 5.0 mm	1710.05002	5.0	0.1969	–
Ø 6.0 mm	1710.06002	6.0	0.2362	–
PG 10-CF [inch]				
Ø 1/8"	1710.03183	3.175	0.125	1/8"
Ø 3/16"	1710.04763	4.763	0.1875	3/16"
Ø 1/4"	1710.06353	6.35	0.25	1/4"
PG 15-CF [mm]				
Ø 3.0 mm	1715.03002	3.0	0.1181	–
Ø 4.0 mm	1715.04002	4.0	0.1575	–
Ø 5.0 mm	1715.05002	5.0	0.1969	–
Ø 6.0 mm	1715.06002	6.0	0.2362	–
Ø 7.0 mm	1715.07002	7.0	0.2756	–
Ø 8.0 mm	1715.08002	8.0	0.315	–
Ø 9.0 mm	1715.09002	9.0	0.3543	–
Ø 10.0 mm	1715.10002	10.0	0.3937	–
PG 15-CF [inch]				
Ø 1/8"	1715.03183	3.175	0.125	1/8"
Ø 3/16"	1715.04763	4.763	0.1875	3/16"
Ø 1/4"	1715.06353	6.35	0.25	1/4"
Ø 5/16"	1715.07943	7.938	0.3125	5/16"
Ø 3/8"	1715.09523	9.525	0.375	3/8"

Type	Part no.	Ø		
		[mm]	[decimal inch]	[inch]
PG 25-CF [inch]				
Ø 3.0 mm	1725.03002	3.0	0.1181	–
Ø 4.0 mm	1725.04002	4.0	0.1575	–
Ø 5.0 mm	1725.05002	5.0	0.1969	–
Ø 6.0 mm	1725.06002	6.0	0.2362	–
Ø 7.0 mm	1725.07002	7.0	0.2756	–
Ø 8.0 mm	1725.08002	8.0	0.315	–
Ø 9.0 mm	1725.09002	9.0	0.3543	–
Ø 10.0 mm	1725.10002	10.0	0.3937	–
Ø 11.0 mm	1725.11002	11.0	0.4331	–
Ø 12.0 mm	1725.12002	12.0	0.4724	–
Ø 13.0 mm	1725.13002	13.0	0.5118	–
Ø 14.0 mm	1725.14002	14.0	0.5512	–
Ø 15.0 mm	1725.15002	15.0	0.5906	–
Ø 16.0 mm	1725.16002	16.0	0.63	–
Ø 18.0 mm	1725.18002	18.0	0.7087	–
Ø 20.0 mm	1725.20002	20.0	0.7874	–

PG 25-CF [inch]				
Ø 1/8"	1725.03183	3.175	0.125	1/8"
Ø 3/16"	1725.04763	4.763	0.1875	3/16"
Ø 1/4"	1725.06353	6.35	0.25	1/4"
Ø 5/16"	1725.07943	7.938	0.3125	5/16"
Ø 3/8"	1725.09523	9.525	0.375	3/8"
Ø 7/16"	1725.11113	11.113	0.4375	7/16"
Ø 1/2"	1725.12703	12.7	0.5	1/2"
Ø 9/16"	1725.14293	14.288	0.5625	9/16"
Ø 5/8"	1725.15883	15.875	0.625	5/8"
Ø 3/4"	1725.19053	19.05	0.75	3/4"



Type	Part no.	Ø		
		[mm]	[decimal inch]	[inch]
PG 32-CF [mm]				
Ø 6.0 mm	1732.06002	6.0	0.2362	–
Ø 7.0 mm	1732.07002	7.0	0.2756	–
Ø 8.0 mm	1732.08002	8.0	0.315	–
Ø 9.0 mm	1732.09002	9.0	0.3543	–
Ø 10.0 mm	1732.10002	10.0	0.3937	–
Ø 11.0 mm	1732.11002	11.0	0.4331	–
Ø 12.0 mm	1732.12002	12.0	0.4724	–
Ø 14.0 mm	1732.14002	14.0	0.5512	–
Ø 16.0 mm	1732.16002	16.0	0.63	–
Ø 18.0 mm	1732.18002	18.0	0.7087	–
Ø 20.0 mm	1732.20002	20.0	0.7874	–
Ø 22.0 mm	1732.22002	22.0	0.8661	–
Ø 25.0 mm	1732.25002	25.0	0.9843	–

PG 32-CF [inch]				
Ø 1/4"	1732.06353	6.35	0.25	1/4"
Ø 5/16"	1732.07943	7.938	0.3125	5/16"
Ø 3/8"	1732.09523	9.525	0.375	3/8"
Ø 7/16"	1732.11113	11.113	0.4375	7/16"
Ø 1/2"	1732.12703	12.7	0.5	1/2"
Ø 9/16"	1732.14293	14.288	0.5625	9/16"
Ø 5/8"	1732.15883	15.875	0.625	5/8"
Ø 3/4"	1732.19053	19.05	0.75	3/4"
Ø 7/8"	1732.22233	22.225	0.875	7/8"
Ø 1"	1732.25403	25.4	1.0	1"



Long shank collets PG-L

PG-L

powRgrip®

Type	Part no.	Ø		
		[mm]	[decimal inch]	[inch]
PG 15-L [mm]				
Ø 4.0 mm	1715.04001	4.0	0.1575	–
Ø 5.0 mm	1715.05001	5.0	0.1969	–
Ø 6.0 mm	1715.06001	6.0	0.2362	–
Ø 8.0 mm	1715.08001	8.0	0.315	–
Ø 10.0 mm	1715.10001	10.0	0.3937	–

PG 15-L [inch]				
Ø 1/4"	1715.06350	6.35	0.25	1/4"
Ø 5/16"	1715.07940	7.94	0.3126	5/16"
Ø 3/8"	1715.09520	9.52	0.3748	3/8"

PG 25-L [mm]				
Ø 6.0 mm	1725.06001	6.0	0.2362	–
Ø 8.0 mm	1725.08001	8.0	0.315	–
Ø 10.0 mm	1725.10001	10.0	0.3937	–
Ø 12.0 mm	1725.12001	12.0	0.4724	–
Ø 14.0 mm	1725.14001	14.0	0.5512	–
Ø 16.0 mm	1725.16001	16.0	0.6299	–
Ø 20.0 mm	1725.20001	20.0	0.7874	–

PG 25-L [inch]				
Ø 1/4"	1725.06350	6.35	0.25	1/4"
Ø 5/16"	1725.07940	7.94	0.3126	5/16"
Ø 3/8"	1725.09520	9.52	0.3748	3/8"
Ø 1/2"	1725.12700	12.7	0.5	1/2"
Ø 5/8"	1725.15880	15.88	0.6252	5/8"
Ø 3/4"	1725.19050	19.05	0.75	3/4"

PG 32-L [mm]				
Ø 12.0 mm	1732.12001	12.0	0.4724	–
Ø 16.0 mm	1732.16001	16.0	0.6299	–
Ø 20.0 mm	1732.20001	20.0	0.7874	–
Ø 25.0 mm	1732.25001	25.0	0.9843	–

PG 32-L [inch]				
Ø 1/2"	1732.12700	12.7	0.5	1/2"
Ø 3/4"	1732.19050	19.05	0.75	3/4"
Ø 1"	1732.25400	25.4	1.0	1"



Type	Part no.	[mm]	[decimal inch]	\emptyset [inch]
PG 6-S [mm]				
\emptyset 3.0 mm	1706.03008	3.0	0.1181	–
PG 6-S [Inch]				
\emptyset 1/8"	1706.03188	3.175	0.125	1/8"
PG 10-S [mm]				
\emptyset 3.0 mm	1710.03008	3.0	0.1181	–
\emptyset 4.0 mm	1710.04008	4.0	0.1575	–
\emptyset 6.0 mm	1710.06008	6.0	0.2362	–
PG 10-S [Inch]				
\emptyset 1/8"	1710.03188	3.175	0.125	1/8"
\emptyset 3/16"	1710.04768	4.763	0.1875	3/16"
\emptyset 1/4"	1710.06358	6.35	0.25	1/4"
PG 15-S [mm]				
\emptyset 4.0 mm	1715.04008	4.0	0.1575	–
\emptyset 5.0 mm	1715.05008	5.0	0.1969	–
\emptyset 6.0 mm	1715.06008	6.0	0.2362	–
\emptyset 8.0 mm	1715.08008	8.0	0.315	–
\emptyset 10.0 mm	1715.10008	10.0	0.3937	–
PG 15-S [Inch]				
\emptyset 1/8"	1715.03188	3.175	0.125	1/8"
\emptyset 3/16"	1715.04768	4.763	0.1875	3/16"
\emptyset 1/4"	1715.06358	6.35	0.25	1/4"
\emptyset 5/16"	1715.07948	7.94	0.3126	5/16"
\emptyset 3/8"	1715.09528	9.52	0.3748	3/8"
PG 25-S [mm]				
\emptyset 4.0 mm	1725.04008	4.0	0.1575	–
\emptyset 6.0 mm	1725.06008	6.0	0.2362	–
\emptyset 8.0 mm	1725.08008	8.0	0.315	–
\emptyset 10.0 mm	1725.10008	10.0	0.3937	–
\emptyset 12.0 mm	1725.12008	12.0	0.4724	–
\emptyset 14.0 mm	1725.14008	14.0	0.5512	–
\emptyset 16.0 mm	1725.16008	16.0	0.6299	–
\emptyset 20.0 mm	1725.20008	20.0	0.7874	–

Short shank collets PG-S

PG-S

powRgrip®

Type	Part no.	[mm]	[decimal inch]	\emptyset [inch]
PG 25-S [Inch]				
Ø 1/8"	1725.03188	3.175	0.125	1/8"
Ø 3/16"	1725.04768	4.763	0.1875	3/16"
Ø 1/4"	1725.06358	6.358	0.2503	1/4"
Ø 5/16"	1725.07948	7.94	0.3126	5/16"
Ø 3/8"	1725.09528	9.52	0.3748	3/8"
Ø 1/2"	1725.12708	12.7	0.5	1/2"
Ø 5/8"	1725.15888	15.88	0.6252	5/8"
Ø 3/4"	1725.19058	19.05	0.75	3/4"

PG 32-S [mm]				
Ø 12.0 mm	1732.12008	12.0	0.4724	–
Ø 16.0 mm	1732.16008	16.0	0.6299	–
Ø 20.0 mm	1732.20008	20.0	0.7874	–
Ø 25.0 mm	1732.25008	25.0	0.9843	–

PG 32-S [Inch]				
Ø 1/2"	1732.12708	12.7	0.5	1/2"
Ø 3/4"	1732.19058	19.05	0.75	3/4"
Ø 1"	1732.25408	25.4	1.0	1"



Type	Part no.	Ø			Accessory
		[mm]	[decimal inch]	[inch]	Wrench
PG 15-T [mm]					
Ø 5.0 mm	1715.05007	5.0	0.1969	–	TORX T 6
Ø 6.0 mm	1715.06007	6.0	0.2362	–	TORX T 6
Ø 8.0 mm	1715.08007	8.0	0.315	–	TORX T 6
Ø 10.0 mm	1715.10007	10.0	0.3937	–	TORX T 6

PG 15-T [Inch]					
Ø 1/4"	1715.06357	6.35	0.25	1/4"	TORX T 6
Ø 3/8"	1715.09537	9.525	0.375	3/8"	TORX T 6

PG 25-T [mm]					
Ø 5.0 mm	1725.05007	5.0	0.1969	–	TORX T 8
Ø 6.0 mm	1725.06007	6.0	0.2362	–	TORX T 8
Ø 8.0 mm	1725.08007	8.0	0.315	–	TORX T 8
Ø 10.0 mm	1725.10007	10.0	0.3937	–	TORX T 8
Ø 12.0 mm	1725.12007	12.0	0.4724	–	TORX T 8
Ø 16.0 mm	1725.16007	16.0	0.6299	–	TORX T 8
Ø 20.0 mm	1725.20007	20.0	0.7874	–	TORX T 8

PG 25-T [Inch]					
Ø 1/4"	1725.06357	6.35	0.25	1/4"	TORX T 8
Ø 3/8"	1725.09537	9.525	0.375	3/8"	TORX T 8
Ø 1/2"	1725.12707	12.7	0.5	1/2"	TORX T 8
Ø 3/4"	1725.19057	19.05	0.75	3/4"	TORX T 8



Type	Part no.	Use for
Wrenches for PG-T		
TORX T 6	7693.06000	PG 15-T
TORX T 8	7693.08000	PG 25-T

Expert advice

The torque screwdriver is a special TORX style wrench that is preset to the recommended torque rating of 0.9 Nm for tightening the REGO-FIX PG-T collets.

Type	Part no.	Ø		
		[mm]	[decimal inch]	[inch]
PG 15-SG [mm]				
Ø 10.0 mm	1715.10004	10.0	0.3937	–
PG 25-SG [mm]				
Ø 10.0 mm	1725.10004	10.0	0.3937	–
Ø 12.0 mm	1725.12004	12.0	0.4724	–
Ø 14.0 mm	1725.14004	14.0	0.5512	–
Ø 16.0 mm	1725.16004	16.0	0.63	–
Ø 18.0 mm	1725.18004	18.0	0.7087	–
Ø 20.0 mm	1725.20004	20.0	0.7874	–
PG 25-SG [Inch]				
Ø 1/2"	1725.12704	12.7	0.5	1/2"
Ø 5/8"	1725.15884	15.875	0.625	5/8"
Ø 3/4"	1725.19054	19.05	0.75	3/4"
PG 32-SG [mm]				
Ø 10.0 mm	1732.10004	10.0	0.3937	–
Ø 12.0 mm	1732.12004	12.0	0.4724	–
Ø 14.0 mm	1732.14004	14.0	0.5512	–
Ø 16.0 mm	1732.16004	16.0	0.63	–
Ø 18.0 mm	1732.18004	18.0	0.7087	–
Ø 20.0 mm	1732.20004	20.0	0.7874	–
Ø 25.0 mm	1732.25004	25.0	0.9843	–
PG 32-SG [Inch]				
Ø 1/2"	1732.12704	12.7	0.5	1/2"
Ø 5/8"	1732.15884	15.875	0.625	5/8"
Ø 3/4"	1732.19054	19.05	0.75	3/4"
Ø 1"	1732.25404	25.4	1.0	1"
Threaded insert SGI [mm]		Threaded insert SGI [inch]		
Ø 10.0 mm	7694.10000	Ø 1/2"	7694.12700	
Ø 12.0 mm	7694.12000	Ø 5/8"	7694.15880	
Ø 14.0 mm	7694.14000	Ø 3/4"	7694.19050	
Ø 16.0 mm	7694.16000	Ø 1"	7694.25400	
Ø 18.0 mm	7694.18000			
Ø 20.0 mm	7694.20000			
Ø 25.0 mm	7694.25000			

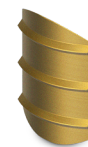

Threaded insert SGI

[Learn more](#)

For more information about secuRgrip® see page 277.

Tapping collet PG-TAP

PG-TAP

DIN 371

DIN 376

ANSI

Type	Part no.	Ø [mm]	Square [mm]	DIN norm
PG 15-TAP				
Ø 3.5 x 2.7 mm	1715.03505	3.5	2.7	371/376
Ø 4.5 x 3.4 mm	1715.04505	4.5	3.4	371/376
Ø 6.0 x 4.9 mm	1715.06005	6.0	4.9	371/376
Ø 7.0 x 5.5 mm	1715.07005	7.0	5.5	371/376
Ø 8.0 x 6.2 mm	1715.08005	8.0	6.2	371/376
Ø 9.0 x 7.0 mm	1715.09005	9.0	7.0	371/376
Ø 10.0 x 8.0 mm	1715.10005	10.0	8.0	371

PG 25-TAP				
Ø 6.0 x 4.9 mm	1725.06005	6.0	4.9	371/376
Ø 8.0 x 6.2 mm	1725.08005	8.0	6.2	371/376
Ø 9.0 x 7.0 mm	1725.09005	9.0	7.0	371/376
Ø 10.0 x 8.0 mm	1725.10005	10.0	8.0	371
Ø 11.0 x 9.0 mm	1725.11005	11.0	9.0	371/376
Ø 12.0 x 9.0 mm	1725.12005	12.0	9.0	371/376
Ø 14.0 x 11.0 mm	1725.14005	14.0	11.0	371/376
Ø 16.0 x 12.0 mm	1725.16005	16.0	12.0	371/376

Type	Part no.	Ø [inch]	Square [inch]	Norm
PG 15-TAP [inch]				
Ø 0.141/□ 0.110"	1725.03585	0.141	0.110	ANSI
Ø 0.168/□ 0.131"	1725.04275	0.168	0.131	ANSI
Ø 0.194/□ 0.152"	1725.04935	0.194	0.152	ANSI
Ø 0.220/□ 0.165"	1725.05595	0.220	0.165	ANSI
Ø 0.255/□ 0.191"	1725.06485	0.255	0.191	ANSI

PG 25-TAP [inch]				
Ø 0.318/□ 0.238"	1725.08085	0.318	0.238	ANSI
Ø 0.367/□ 0.275"	1725.09325	0.367	0.275	ANSI
Ø 0.381/□ 0.286"	1725.09685	0.381	0.286	ANSI

Expert advice

For imperial thread sizes and corresponding squares [□] see page 336.

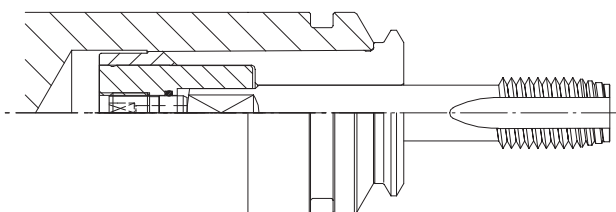

PG-TAP



PG-TAP



Max 70Nm

10245











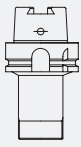
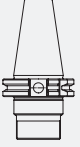
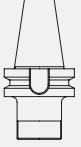

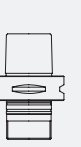
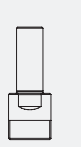
10245

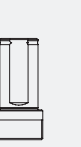

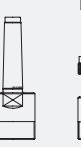

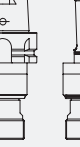

Art. Nr. 47120















10245



Experience the widest ER range

Standard					Cylindrical colletholders					Colletholders for tapping			Floating chucks		Collet reductions	
HSK/ER	SK/ER	BT/ER	CAT/ER	CAPTO/ER	CYL/ER	CYL/ERM(X) CYLF/ERM(X)	CYL/ER NC	CYDF/ERM CYDF/ERM(X)	MK/ER	SH/ER	ISO 20/ER	HSK-A SSS	CYL SSS CYL GSF	PH/ER PHC/ER PHC-C/ER	MPH/ERM(X)	ER(M)/ERM ER(MX)/ERM(X)
																
page 70	page 76	page 80	page 88	page 94	page 98	page 102	page 107	page 108	page 110	page 112	page 114	page 116	page 116	page 119	page 122	page 127





Micro-machining	Standard and ultraprecision	micRun®	Metallic sealed	Pullout protection secuRgrip®	Collets for tapping	
ER-MB	ER-Standard/ ER-UP	MR	ER-DM	ER-SG	ER-GB	PCM ET1
						
page 134	page 135	page 199	page 144	page 149	page 150	page 154



Standard		Standard with bearing		Mini nut		Slip-off proof mini nut		External thread			Sealing and coolant flush disks		
Hi-Q®/ER	Hi-Q®/ERC	Hi-Q®/ERB	Hi-Q®/ERBC	Hi-Q®/ERM	Hi-Q®/ERMC	Hi-Q®/ERM intRlox®	Hi-Q®/ERM(X) intRlox®	ER MS	Hi-Q®/ERAX	Hi-Q®/ERAXC	reCool® RCR/RCS	DS/ER	KS/ER
													
page 160	page 162	page 164	page 164	page 166	page 166	page 168	page 168	page 170	page 172	page 172	page 174	page 244	page 252

B: bearing C: cooling M: mini thread X: slip-off proof A: external thread



DS: sealing disk KS: coolant flush disk

Standard



HSK/ ER	SK/ ER	BT/ ER	CAT/ ER	CAPTO/ ER
				
page 70	page 76	page 80	page 88	page 94

MK/ ER	SH/ ER	ISO 20/ ER
		
page 110	page 112	page 114

**Colletholders
for tapping**

HSK-A SSY	CYL SSY CYL GSF
	
page 116	page 116

**Floating
chucks**

PH/ER PHC/ER PHC-C/ER	MPH/ ERMX
	
page 119	page 122

**Collet
reductions**

ER(M)/ ERM ER(MX)/ ERMX

page 127



Swiss quality ER toolholders



	HSK/ER	SK/ER	BT/ER	BT+/ER	CAT/ER	CAT+/ER	CAPTO/ER
Norm	DIN 69893	DIN 69871	MAS 403 JIS B 6339	–	ASME B5.50	–	–
ISO	ISO 12164	ISO 7388-1	ISO 7388-2	–	–	–	ISO 26623
Balancing	G 2.5 @ 25,000 min ⁻¹	G 2.5 @ 25,000 min ⁻¹	G 2.5 @ 25,000 min ⁻¹	G 2.5 @ 25,000 min ⁻¹	G 2.5 @ 25,000 min ⁻¹	G 2.5 @ 25,000 min ⁻¹	G 2.5 @ 25,000 min ⁻¹
Chip hole	HSK-A	•	–	–	–	–	–
Runout TIR (outer taper to inner cone)	≤0.003 mm	≤0.003 mm	≤0.003 mm	≤0.003 mm	≤0.003 mm	≤0.003 mm	≤0.003 mm
Taper tolerance	DIN ISO	AT3	AT3	AT1	AT3	AT1	ISO 26623
MFD*	–	–	–	–	–	–	–
Form A + AD	–	•	•	•	•	•	–
Form AD + B	–	•	•	–	•	–	–

*micro friction dampening technology



	HSK-A/ER XL	SK/ER XL	BT/ER XL	CAT/ER XL	CAPTO/ER XL
Norm	DIN 69893	DIN 69871	MAS 403 JIS B 6339	ASME B5.50	–
ISO	ISO 12164	ISO 7388-1	ISO 7388-2	–	ISO 26623
Balancing	G 2.5 @ 5,000 min ⁻¹	G 2.5 @ 5,000 min ⁻¹	G 2.5 @ 5,000 min ⁻¹	G 2.5 @ 5,000 min ⁻¹	G 2.5 @ 5,000 min ⁻¹
Chip hole	HSK-A	•	–	–	–
Runout TIR (outer taper to inner cone)	≤0.01 mm	≤0.01 mm	≤0.01 mm	≤0.01 mm	≤0.01 mm
Taper tolerance	DIN ISO	AT3	AT3	AT3	ISO 26623
MFD*	•	•	•	•	•
Form A + AD	–	•	•	•	–
Form AD + B	–	–	–	–	–

*micro friction dampening technology

Cylindrical collets

CYL/
ER



page 98

CYL/
ERM(X)
CYLF/
ERM(X)



page 106

CYL/
ER NC



page 107

CYDF/
ERM
CYDF/
ERM(X)



page 108



Swiss quality ER toolholders



	CYL/ER	CYL/ERM	CYL/ERMX	CYLF/ERM
Shank tolerance	h6	h6	h6	h6
Runout TIR (shank to cone)	≤0.003 mm	≤0.003 mm	≤0.003 mm	≤0.005 mm
Rotary applications	•	•	•	–
Clamping flat	–	–	–	•
Double ER	–	–	–	–
Slip-off proof	–	–	•	–
Minimal outer diameter	–	•	•	•



	CYLF/ERMX	CYDF/ERM	CYDF/ERMX	CYL/ERNC
Shank tolerance	h6	h6	h6	h6
Runout TIR (shank to cone)	≤0.005 mm	≤0.005 mm	≤0.005 mm	≤0.005 mm
Rotary applications	–	–	–	–
Clamping flat	•	•	•	•
Double ER	–	•	•	–
Slip-off proof	•	–	•	–
Minimal outer diameter	•	•	•	–

HSK toolholders

Designed for rotating applications, all our HSK toolholders are suited for high-speed applications where consistent performance is key.

DIN 69893 / ISO 12164

Features and benefits

Runout TIR $\leq 3 \mu\text{m}$

Measured from inner taper to outer taper.

Surface finish max. Ra 0.25

Achieve high clamping force and high transferable torque.

Balancing

100% balanced to G 2.5 @ 25,000 rpm / <1gmm.

XL toolholders

100% balanced to G 2.5 @ 5,000 rpm.
TIR from inner to outer taper <10 μm .

Hi-Q® balancing system

Ready to accept Hi-Q® balancing rings which allow for the offset of the imbalance introduced by the cutting tool up to 80,000 rpm depending on the balancing rings used. All toolholders with the additional type information "H" in the article name are designed for balancing rings.

Hi-Q®/ER clamping nut included in delivery

Guarantees highest clamping force and best balancing.

Vibration dampening

Our holders offer a good vibration dampening to sustain a high surface finish and can prevent cutting force alterations.

Special applications

When extra high clamping force is needed, e.g., when tapping with ER-GB, we recommend to use our friction-bearing clamping nuts Hi-Q®/ERB and Hi-Q®/ERBC.

ID chip hole (only HSK form A)

In accordance with DIN 69873 for 10 mm diameter.
Available on request.

*Accessories are not included in delivery. HSK-A 125 available on request
Other XL sizes available on request*

Balancing specifications

HSK 25	balanced to 90,000 min ⁻¹
HSK 32	balanced to 60,000 min ⁻¹
HSK 40	balanced to 45,000 min ⁻¹
HSK 50	balanced to 36,000 min ⁻¹
HSK 63	G 2.5 @ 25,000 min ⁻¹
HSK 80	G 2.5 @ 25,000 min ⁻¹
HSK 100	G 2.5 @ 25,000 min ⁻¹
HSK 125	G 2.5 @ 25,000 min ⁻¹



Expert advice

For all HSK-A and HSK-E form toolholders a range of coolant tubes (KSR) is available.
For KSR part numbers please refer to page 265.

HSK-A toolholders

HSK-A

DIN 69893

ISO 12164

Type	Part no.	Dimensions [mm]				Accessories	
		D	D1	L	L1	FWR*	Wrench
HSK-A 32							
HSK-A 32/ER 11 x 050	2532.11110	19	–	50	–	–	E 11 P
HSK-A 32/ER 16 x 060	2532.11620	28	–	60	–	–	E 16 P
HSK-A 32/ER 20 x 060	2532.12020	34	–	60	–	–	E 20 P
HSK-A 32/ER 25 x 065	2532.12520	42	–	65	–	–	E 25
HSK-A 40							
HSK-A 40/ER 16 x 080 H	4540.11640	28	–	80	–	225	E 16 P
HSK-A 40/ER 25 x 080 H	4540.12540	42	–	80	–	325	E 25
HSK-A 50							
HSK-A 50/ER 16 x 100 H	4550.11650	28	–	100	–	325	E 16 P
HSK-A 50/ER 25 x 080 H	4550.12540	42	–	80	–	325	E 25
HSK-A 50/ER 25 x 100 H	4550.12550	42	–	100	–	325	E 25
HSK-A 50/ER 32 x 100 H	4550.13250	50	–	100	–	405	E 32
HSK-A 63							
HSK-A 63/ER 11 x 100 H	4563.11150	19	–	100	–	325	E 11 P
HSK-A 63/ER 16 x 080 H	4563.11640	28	–	80	–	325	E 16 P
HSK-A 63/ER 16 x 100 H	4563.11650	28	–	100	–	325	E 16 P
HSK-A 63/ER 16 x 160 H	4563.11680	28	–	160	–	325/225	E 16 P
HSK-A 63/ER 16 x 240 XL	8865.13070	28	46	240	140	–	E 16 P
HSK-A 63/ER 16 x 260 XL	8865.13090	28	46	260	140	–	E 16 P
HSK-A 63/ER 16 x 300 XL	8865.13130	28	46	300	140	–	E 16 P
HSK-A 63/ER 16 x 340 XL	8865.13170	28	46	340	240	–	E 16 P
HSK-A 63/ER 16 x 360 XL	8865.13190	28	46	360	240	–	E 16 P
HSK-A 63/ER 16 x 400 XL	8865.13230	28	46	400	240	–	E 16 P
HSK-A 63/ER 20 x 075	2563.12030	34	–	75	–	–	E 20 P
HSK-A 63/ER 25 x 080 H	4563.12540	42	–	80	–	325	E 25
HSK-A 63/ER 25 x 100 H	4563.12550	42	–	100	–	325	E 25
HSK-A 63/ER 25 x 160 H	4563.12580	42	–	160	–	325	E 25
HSK-A 63/ER 25 x 200 H	4563.12590	42	–	200	–	405/325	E 25
HSK-A 63/ER 32 x 080 H	4563.13240	50	–	80	–	405	E 32
HSK-A 63/ER 32 x 100 H	4563.13250	50	–	100	–	405	E 32
HSK-A 63/ER 32 x 160 H	4563.13280	50	–	160	–	405	E 32
HSK-A 63/ER 32 x 200 H	4563.13290	50	–	200	–	405/405	E 32
HSK-A 63/ER 32 x 240 XL	8865.16070	50	55	240	140	–	E 32
HSK-A 63/ER 32 x 260 XL	8865.16090	50	55	260	140	–	E 32
HSK-A 63/ER 32 x 340 XL	8865.16170	50	55	340	240	–	E 32
HSK-A 63/ER 32 x 360 XL	8865.16190	50	55	360	240	–	E 32

*Balancing rings H: Ready to accept balancing rings

Included in delivery: Toolholders with Hi-Q®/ER clamping nut and back-up screw

HSK-A toolholders

HSK-A

DIN 69893

ISO 12164

Type	Part no.	Dimensions [mm]				Accessories	
		D	D1	L	L1	FWR*	Wrench
HSK-A 63/ER 40 x 080	2563.14040	63	–	80	–	–	E 40
HSK-A 63/ER 40 x 120 H	4563.14060	63	–	120	–	505	E 40
HSK-A 63/ER 40 x 160 H	4563.14080	63	–	160	–	505	E 40

HSK-A 80

HSK-A 80/ER 16 x 100 H	4580.11650	28	–	100	–	325	E 16 P
HSK-A 80/ER 16 x 160 H	4580.11680	28	–	160	–	325/225	E 16 P
HSK-A 80/ER 32 x 100 H	4580.13250	50	–	100	–	405	E 32
HSK-A 80/ER 40 x 120 H	4580.14060	63	–	120	–	505	E 40

HSK-A 100

HSK-A 100/ER 16 x 100 H	4500.11650	28	–	100	–	405	E 16 P
HSK-A 100/ER 16 x 160 H	4500.11680	28	–	160	–	405/225	E 16 P
HSK-A 100/ER 16 x 200 H	4500.11690	28	–	200	–	405/225	E 16 P
HSK-A 100/ER 16 x 240 XL	8885.13070	28	46	240	140	–	E 16 P
HSK-A 100/ER 16 x 300 XL	8885.13130	28	46	300	140	–	E 16 P
HSK-A 100/ER 16 x 340 XL	8885.13170	28	46	340	240	–	E 16 P
HSK-A 100/ER 16 x 400 XL	8885.13230	28	46	400	240	–	E 16 P
HSK-A 100/ER 25 x 100 H	4500.12550	42	–	100	–	405	E 25
HSK-A 100/ER 25 x 160 H	4500.12580	42	–	160	–	405/325	E 25
HSK-A 100/ER 25 x 200 H	4500.12590	42	–	200	–	405/325	E 25
HSK-A 100/ER 32 x 100 H	4500.13250	50	–	100	–	405	E 32
HSK-A 100/ER 32 x 160 H	4500.13280	50	–	160	–	405	E 32
HSK-A 100/ER 32 x 246 XL	8885.16070	50	55	246	140	–	E 32
HSK-A 100/ER 32 x 346 XL	8885.16170	50	55	346	240	–	E 32
HSK-A 100/ER 40 x 120 H	4500.14060	63	–	120	–	505	E 40
HSK-A 100/ER 40 x 200 H	4500.14090	63	–	200	–	505/505	E 40

*Balancing rings H: Ready to accept balancing rings

Included in delivery: Toolholders with HI-Q®/ER clamping nut and back-up screw

HSK-A: Hole for data carrier DIN STD 69873 in the flange

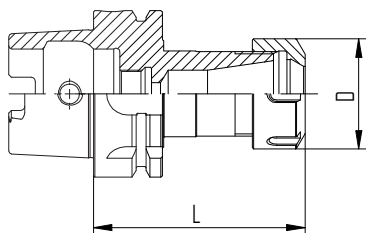

HSK-A/ER

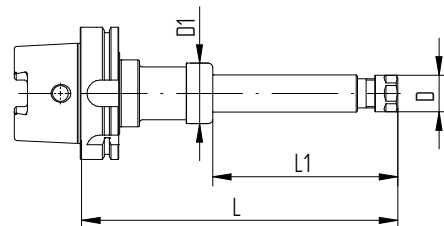

HSK-A/ER XL

HSK-C toolholders

HSK-C

DIN 69893

ISO 12164

Type	Part no.	Dimensions [mm]				Accessories	
		D	D1	L	L1	FWR*	Wrench
HSK-C 32							
HSK-C 32/ER 16 x 060	2532.11622	28	–	60	–	–	E 16 P
HSK-C 32/ER 20 x 060	2532.12022	34	–	60	–	–	E 20 P
HSK-C 32/ER 25 x 070	2532.12532	42	–	70	–	–	E 25
HSK-C 40							
HSK-C 40/ER 20 x 060	2540.12022	34	–	60	–	–	E 20 P
HSK-C 40/ER 25 x 070	2540.12532	42	–	70	–	–	E 25
HSK-C 40/ER 32 x 075	2540.13232	50	–	75	–	–	E 32
HSK-C 50							
HSK-C 50/ER 25 x 070	2550.12532	42	–	70	–	–	E 25
HSK-C 50/ER 32 x 075	2550.13232	50	–	75	–	–	E 32
HSK-C 50/ER 40 x 080	2550.14042	63	–	80	–	–	E 40
HSK-C 63							
HSK-C 63/ER 32 x 075	2563.13232	50	–	75	–	–	E 32
HSK-C 63/ER 40 x 080	2563.14042	63	–	80	–	–	E 40

*Balancing rings H: Ready to accept balancing rings

Included in delivery: Toolholders with Hi-Q®/ER clamping nut and back-up screw

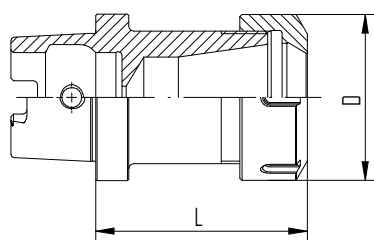

HSK-C/ER

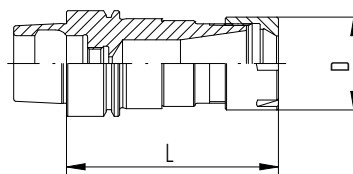

HSK-E/ER M

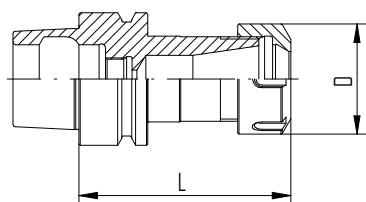

HSK-E/ER

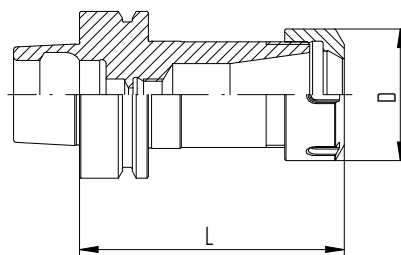

HSK-F/ER

HSK-E toolholders

HSK-F toolholders

HSK-E	HSK-F
DIN 69893	DIN 69893
ISO 12164	ISO 12164

Type	Part no.	Dimensions [mm]				Accessories	
		D	D1	L	L1	FWR*	Wrench
HSK-E 25							
HSK-E 25/ERM 16 x 048	2525.11618	22	–	48	–	–	E 16 M
HSK-E 32							
HSK-E 32/ERM 16 x 060	2532.11628	22	–	60	–	–	E 16 M
HSK-E 32/ERM 20 x 060	2532.12028	28	–	60	–	–	E 20 M
HSK-E 40							
HSK-E 40/ER 11 x 060 H	4540.11124	19	–	60	–	225	E 11 P
HSK-E 40/ER 16 x 060 H	4540.11624	28	–	60	–	225	E 16 P
HSK-E 40/ER 16 x 080 H	4540.11644	28	–	80	–	225	E 16 P
HSK-E 40/ERM 20 x 075 H	4540.12038	28	–	75	–	285	E 20 M
HSK-E 40/ERM 25 x 080 H	4540.12548	35	–	80	–	325	E 25 M
HSK-E 50							
HSK-E 50/ER 16 x 060	2550.11624	28	–	60	–	–	E 16 P
HSK-E 50/ER 16 x 100 H	4550.11654	28	–	100	–	325	E 16 P
HSK-E 50/ER 16 x 160 H	4550.11684	28	–	160	–	325/225	E 16 P
HSK-E 50/ER 20 x 070 H	4550.12034	34	–	70	–	325	E 20 P
HSK-E 50/ER 25 x 080 H	4550.12544	42	–	80	–	325	E 25
HSK-E 50/ER 25 x 100 H	4550.12554	42	–	100	–	325	E 25
HSK-E 50/ER 32 x 100 H	4550.13254	50	–	100	–	405	E 32
HSK-E 50/ER 32 x 160 H	4550.13284	50	–	160	–	405	E 32
HSK-E 63							
HSK-E 63/ER 32 x 090 H	4563.13244	50	–	90	–	405	E 32
HSK-E 63/ER 40 x 080	2563.14044	63	–	80	–	–	E 40
HSK-E 63/ER 40 x 120 H	4563.14064	63	–	120	–	505	E 40
HSK-F 63							
HSK-F 63/ER 16 x 100 H	4563.11655	28	–	100	–	325	E 16 P
HSK-F 63/ER 25 x 100 H	4563.12555	42	–	100	–	325	E 25
HSK-F 63/ER 32 x 100 H	4563.13255	50	–	100	–	405	E 32
HSK-F 63/ER 40 x 120 H	4563.14065	63	–	120	–	505	E 40
HSK-FP**							
HSK-FP 80/ER 16 X 3" H	8020.13400	25	–	76.2	–	285	E 16 P
HSK-FP 80/ER 32 X 3" H	8020.13300	50	–	76.2	–	405	E 32

*Balancing rings H: Ready to accept balancing rings

Included in delivery: Toolholders with Hi-Q®/ER clamping nut and back-up screw

**USA only



Steep taper toolholders SK

Universally suitable for different machining applications.

DIN 69871 / DIN ISO 7388-1

Features and benefits

Runout TIR $\leq 3 \mu\text{m}$

Measured from inner taper to outer taper.

Taper accuracy AT3

Better spindle-to-holder fit and accuracy.

Surface finish max. Ra 0.25

Achieve high clamping force and high transferable torque.

Balancing

100% balanced to G 2.5 @ 25,000 rpm / <1gmm.

XL toolholders

100% balanced to G 2.5 @ 5,000 rpm.
TIR from inner to outer taper <10 μm .

Hi-Q® balancing system

Ready to accept Hi-Q® balancing rings which allow for the offset of the imbalance introduced by the cutting tool up to 80,000 rpm depending on the balancing rings used. All toolholders with the additional type information "H" in the article name are designed for balancing rings.

Hi-Q®/ER clamping nut included in delivery

Guarantees highest clamping force and best balancing.

Vibration dampening

Our holders offer good vibration dampening to sustain a high surface finish and can help prevent chatter.

ID chip hole

In accordance with DIN 69873 for 10 mm diameter.

Accessories are not included in delivery. Other XL sizes available on request

Balancing specifications

SK 30	balanced to 30,000 min ⁻¹
SK 40	G 2.5 @ 25,000 min ⁻¹
SK 50	G 2.5 @ 25,000 min ⁻¹

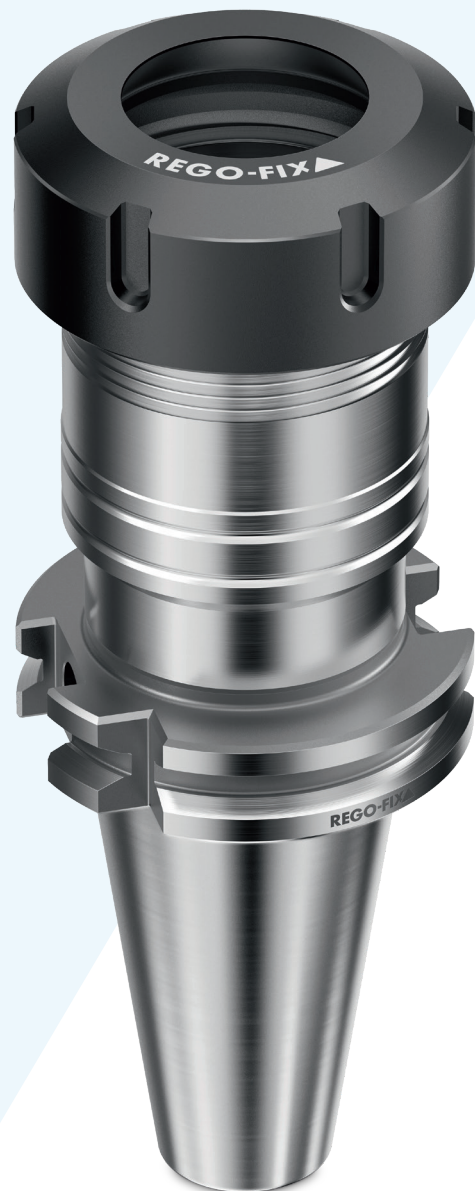

SK toolholders

ERA-Zero-Z® toolholders

SK

DIN 69871

DIN ISO 7388-1

Type	Part no.	Dimensions [mm]				Accessories	
		D	D1	L	L1	FWR*	Wrench
SK 30							
SK 30/ER 16 x 070 H	4230.11630	28	–	70	–	285	E 16 P
SK 30/ER 16 x 100 H	4230.11650	28	–	100	–	285	E 16 P
SK 30/ER 25 x 060 H	4230.12520	42	–	60	–	325	E 25
SK 30/ER 32 x 065	2230.13220	50	–	65	–	–	E 32
SK 40							
SK 40/ER 11 x 100 H	4240.11150	19	–	100	–	325	E 11 P
SK 40/ER 11 x 160 H	4240.11180	19	–	160	–	325	E 11 P
SK 40/ER 16 x 070 H	4240.11630	28	–	70	–	405	E 16 P
SK 40/ER 16 x 100 H	4240.11650	28	–	100	–	405	E 16 P
SK 40/ER 16 x 160 H	4240.11680	28	–	160	–	405/225	E 16 P
SK 40/ER 16 x 200 H	4240.11690	28	–	200	–	405/225	E 16 P
SK 40/ER 16 x 260 XL	8842.13090	28	46	260	140	–	E 16 P
SK 40/ER 16 x 300 XL	8842.13130	28	46	300	140	–	E 16 P
SK 40/ER 16 x 320 XL	8842.13150	28	46	320	240	–	E 16 P
SK 40/ER 16 x 360 XL	8842.13190	28	46	360	240	–	E 16 P
SK 40/ER 16 x 400 XL	8842.13230	28	46	400	240	–	E 16 P
SK 40/ER 20 x 070 H	4240.12030	34	–	70	–	325	E 20 P
SK 40/ER 20 x 100 H	4240.12050	34	–	100	–	325	E 20 P
SK 40/ER 25 x 070 H	4240.12530	42	–	70	–	405	E 25
SK 40/ER 25 x 100 H	4240.12550	42	–	100	–	405	E 25
SK 40/ER 25 x 160 H	4240.12580	42	–	160	–	405/325	E 25
SK 40/ER 25 x 200 H	4240.12590	42	–	200	–	405/325	E 25
SK 40/ERA 32 x 019	2240.13207	–	–	19	–	–	E 32 AX
SK 40/ER 32 x 070 H	4240.13230	50	–	70	–	405	E 32
SK 40/ER 32 x 100 H	4240.13250	50	–	100	–	405	E 32
SK 40/ER 32 x 160 H	4240.13280	50	–	160	–	405/405	E 32
SK 40/ER 32 x 200 H	4240.13290	50	–	200	–	405/405	E 32
SK 40/ER 32 x 320 XL	8842.16150	50	55	320	240	–	E 32
SK 40/ER 40 x 080	2240.14040	63	–	80	–	–	E 40
SK 40/ER 40 x 100 H	4240.14050	63	–	100	–	405	E 40
SK 40/ER 40 x 160 H	4240.14080	63	–	160	–	505/505	E 40

*Balancing rings H: Ready to accept balancing rings

Included in delivery: ER toolholders come with HI-Q®/ER clamping nut. ERA toolholders come with HI-Q®/ERAX clamping nuts

SK-B toolholders

SK-B
DIN 69871
DIN ISO 7388-1

Type	Part no.	Dimensions [mm]				Accessories	
		D	D1	L	L1	FWR*	Wrench
SK-B 40							
SK-B 40/ER 11 x 100 H	4240.11153	19	–	100	–	325	E 11 P
SK-B 40/ER 11 x 160 H	4240.11183	19	–	160	–	325	E 11 P
SK-B 40/ER 16 x 070 H	4240.11633	28	–	70	–	405	E 16 P
SK-B 40/ER 16 x 100 H	4240.11653	28	–	100	–	405	E 16 P
SK-B 40/ER 16 x 160 H	4240.11683	28	–	160	–	405/225	E 16 P
SK-B 40/ER 16 x 200 H	4240.11693	28	–	200	–	405/225	E 16 P
SK-B 40/ER 20 x 070 H	4240.12033	34	–	70	–	325	E 20 P
SK-B 40/ER 20 x 100 H	4240.12053	34	–	100	–	325	E 20 P
SK-B 40/ER 25 x 070 H	4240.12533	42	–	70	–	405	E 25
SK-B 40/ER 25 x 100 H	4240.12553	42	–	100	–	405	E 25
SK-B 40/ER 25 x 160 H	4240.12583	42	–	160	–	405/325	E 25
SK-B 40/ER 25 x 200 H	4240.12593	42	–	200	–	405/325	E 25
SK-B 40/ER 32 x 070 H	4240.13233	50	–	70	–	405	E 32
SK-B 40/ER 32 x 100 H	4240.13253	50	–	100	–	405	E 32
SK-B 40/ER 32 x 160 H	4240.13283	50	–	160	–	405/405	E 32
SK-B 40/ER 32 x 200 H	4240.13293	50	–	200	–	405/405	E 32
SK-B 40/ER 40 x 080	2240.14043	63	–	80	–	–	E 40
SK-B 40/ER 40 x 100 H	4240.14053	63	–	100	–	505	E 40
SK-B 40/ER 40 x 160 H	4240.14083	63	–	160	–	505/505	E 40

*Balancing rings

Included in delivery: ER toolholders come with Hi-Q®/ER clamping nut. ERA toolholders come with Hi-Q®/ERAX clamping nuts

H: Ready to accept balancing rings

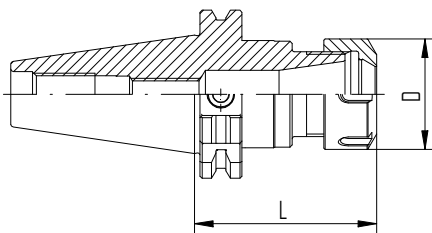

SK/ER (form A+AD)

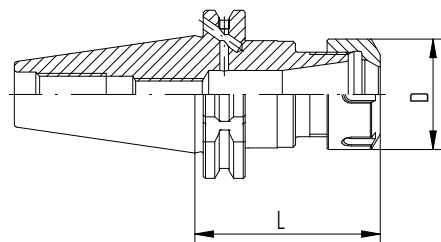

SK-B/ER (form AD+B)

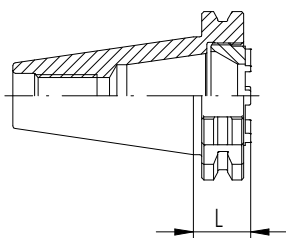

SK/ERA

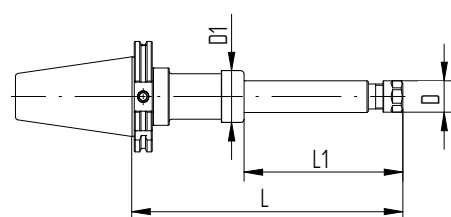

SK/ER XL (form A+AD)

SK toolholders

SK-B toolholders

SK	SK-B
DIN 69871	DIN 69871
DIN ISO 7388-1	DIN ISO 7388-1

Type	Part no.	Dimensions [mm]				Accessories	
		D	D1	L	L1	FWR*	Wrench
SK 50							
SK 50/ER 16 x 100 H	4250.11650	0.25	–	100	–	505	E 16 P
SK 50/ER 16 x 160 H	4250.11680	28	–	160	–	505/225	E 16 P
SK 50/ER 16 x 200 H	4250.11690	28	–	200	–	505/225	E 16 P
SK 50/ER 16 x 240 XL	8852.13070	28	46	240	140	–	E 16 P
SK 50/ER 16 x 300 XL	8852.13130	28	46	300	140	–	E 16 P
SK 50/ER 16 x 340 XL	8852.13170	28	46	340	240	–	E 16 P
SK 50/ER 16 x 400 XL	8852.13230	28	46	400	240	–	E 16 P
SK 50/ER 20 x 070 H	4250.12030	34	–	70	–	325	E 20 P
SK 50/ER 20 x 100 H	4250.12050	34	–	100	–	325	E 20 P
SK 50/ER 25 x 070 H	4250.12530	42	–	70	–	405	E 25
SK 50/ER 25 x 100 H	4250.12550	42	–	100	–	405	E 25
SK 50/ER 25 x 160 H	4250.12580	42	–	160	–	405/325	E 25
SK 50/ER 25 x 200 H	4250.12590	42	–	200	–	405/325	E 25
SK 50/ER 32 x 100 H	4250.13250	50	–	100	–	505	E 32
SK 50/ER 32 x 160 H	4250.13280	50	–	160	–	505/405	E 32
SK 50/ER 32 x 200 H	4250.13290	50	–	200	–	505/405	E 32
SK 50/ER 32 x 320 XL	8852.16150	50	55	320	240	–	E 32
SK 50/ER 40 x 100 H	4250.14050	63	–	100	–	505	E 40
SK 50/ER 40 x 160 H	4250.14080	63	–	160	–	505/505	E 40
SK 50/ER 40 x 200 H	4250.14090	63	–	200	–	505/505	E 40
SK 50/ER 50 x 100	2250.15050	78	–	100	–	–	E 50
SK-B 50							
SK-B 50/ER 16 x 100 H	4250.11653	28	–	100	–	505	E 16 P
SK-B 50/ER 16 x 160 H	4250.11683	28	–	160	–	505/225	E 16 P
SK-B 50/ER 16 x 200 H	4250.11693	28	–	200	–	505/225	E 16 P
SK-B 50/ER 20 x 070 H	4250.12033	34	–	70	–	325	E 20 P
SK-B 50/ER 20 x 100 H	4250.12053	34	–	100	–	325	E 20 P
SK-B 50/ER 25 x 070 H	4250.12533	42	–	70	–	405	E 25
SK-B 50/ER 25 x 100 H	4250.12553	42	–	100	–	405	E 25
SK-B 50/ER 25 x 160 H	4250.12583	42	–	160	–	405/325	E 25
SK-B 50/ER 25 x 200 H	4250.12593	42	–	200	–	405/325	E 25
SK-B 50/ER 32 x 100 H	4250.13253	50	–	100	–	505	E 32
SK-B 50/ER 32 x 160 H	4250.13283	50	–	160	–	505/405	E 32
SK-B 50/ER 32 x 200 H	4250.13293	50	–	200	–	505/405	E 32
SK-B 50/ER 40 x 100 H	4250.14053	63	–	100	–	505	E 40
SK-B 50/ER 40 x 160 H	4250.14083	63	–	160	–	505/505	E 40
SK-B 50/ER 40 x 200 H	4250.14093	63	–	200	–	505/505	E 40

*Balancing rings

Included in delivery: ER toolholders come with Hi-Q®/ER clamping nut. ERA toolholders come with Hi-Q®/ERAX clamping nuts

H: Ready to accept balancing rings

Steep taper toolholders BT

Universally suitable for different machining applications, the BT interface toolholders cater for different machining needs.

MAS 403 / JIS B 6339 / DIN ISO 7388-2

Features and benefits

Runout TIR $\leq 3 \mu\text{m}$

Measured from inner taper to outer taper.

Taper accuracy AT3

Better spindle-to-holder fit and accuracy.

Surface finish max. Ra 0.25

Achieve high clamping force and high transferable torque.

Balancing

100% balanced to G 2.5 @ 25,000 rpm / <1gmm.

XL toolholders

100% balanced to G 2.5 @ 5,000 rpm.
TIR from inner to outer taper <10 μm .

Hi-Q® balancing system

Ready to accept Hi-Q® balancing rings which allow for the offset of the imbalance introduced by the cutting tool up to 80,000 rpm depending on the balancing rings used. All toolholders with the additional type information "H" in the article name are designed for balancing rings.

Hi-Q® / ER clamping nut included in delivery

Guarantees highest clamping force and best balancing.

Vibration dampening

Our holders offer good vibration dampening to sustain a high surface finish and can help prevent chatter.

*Accessories are not included in delivery. HSK-A 125 available on request
Other XL sizes available on request*

Balancing specifications

BT 30	balanced to 30 000 min ⁻¹
BT 40	G 2.5 @ 25 000 min ⁻¹
BT 50	G 2.5 @ 25 000 min ⁻¹



BT toolholders

ERA Zero-Z[®] toolholders

BT

MAS 403

JIS B 6339

DIN ISO 7388-2

Type	Part no.	Dimensions [mm]				Accessories	
		D	D1	L	L1	FWR*	Wrench
BT 30							
BT 30/ER 11 x 050	2130.11110	19	–	50	–	–	E 11 P
BT 30/ER 11 x 100 H	4130.11150	19	–	100	–	225	E 11 P
BT 30/ER 16 x 050	2130.11610	28	–	50	–	–	E 16 P
BT 30/ER 16 x 080 H	4130.11640	28	–	80	–	285	E 16 P
BT 30/ER 16 x 100 H	4130.11650	28	–	100	–	285	E 16 P
BT 30/ERA 20 x 022	2130.12007	–	–	22	–	–	E 20 AX
BT 30/ER 20 x 050	2130.12010	34	–	50	–	–	E 20 P
BT 30/ER 20 x 070 H	4130.12030	34	–	70	–	325	E 20 P
BT 30/ER 20 x 100 H	4130.12050	34	–	100	–	325	E 20 P
BT 30/ER 25 x 060 H	4130.12520	42	–	60	–	325	E 25
BT 30/ER 25 x 100 H	4130.12550	42	–	100	–	325	E 25
BT 30/ER 32 x 060	2130.13220	50	–	60	–	–	E 32
BT 30/ER 32 x 100 H	4130.13250	50	–	100	–	405	E 32

BT 30 ERM**

BT 30/ERM 8 x 100	2130.10855	12	–	100	–	–	E 8 M
BT 30/ERM 11 x 100 H	4130.11155	16	–	100	–	225	E 11 M

*Balancing rings

Included in delivery: ER toolholders come with Hi-Q[®]/ER clamping nut. ERA toolholders come with Hi-Q[®]/ERAX clamping nuts

H: Ready to accept balancing rings

**USA only

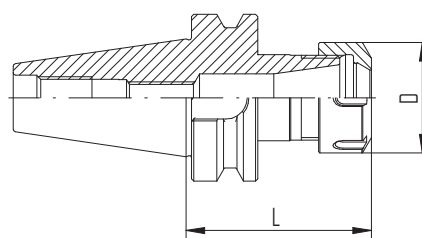

BT/ER (form A+AD)

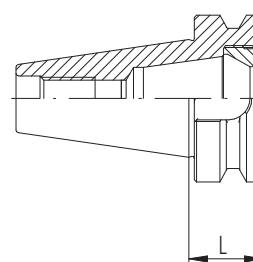

BT/ERA

BT toolholders

ERA Zero-Z[®] toolholders

BT
MAS 403
JIS B 6339
DIN ISO 7388-2

Type	Part no.	Dimensions [mm]				Accessories	
		D	D1	L	L1	FWR*	Wrench
BT 40							
BT 40/ER 11 x 100 H	4140.11150	19	–	100	–	285	E 11 P
BT 40/ER 11 x 160 H	4140.11180	19	–	160	–	285	E 11 P
BT 40/ER 16 x 070 H	4140.11630	28	–	70	–	285	E 16 P
BT 40/ER 16 x 100 H	4140.11650	28	–	100	–	285	E 16 P
BT 40/ER 16 x 160 H	4140.11680	28	–	160	–	285/225	E 16 P
BT 40/ER 16 x 220 XL	8841.13050	28	46	220	140	–	E 16 P
BT 40/ER 16 x 260 XL	8841.13090	28	46	260	140	–	E 16 P
BT 40/ER 16 x 300 XL	8841.13130	28	46	300	140	–	E 16 P
BT 40/ER 16 x 320 XL	8841.13150	28	46	320	240	–	E 16 P
BT 40/ER 16 x 360 XL	8841.13190	28	46	360	240	–	E 16 P
BT 40/ER 16 x 400 XL	8841.13230	28	46	400	240	–	E 16 P
BT 40/ER 20 x 070 H	4140.12030	34	–	70	–	325	E 20 P
BT 40/ER 20 x 100 H	4140.12050	34	–	100	–	285	E 20 P
BT 40/ER 20 x 160 H	4140.12080	34	–	160	–	405/285	E 20 P
BT 40/ER 25 x 070 H	4140.12530	42	–	70	–	325	E 25
BT 40/ER 25 x 100 H	4140.12550	42	–	100	–	405	E 25
BT 40/ER 25 x 160 H	4140.12580	42	–	160	–	405/325	E 25
BT 40/ERA 32 x 027	2140.13207	–	–	27	–	–	E 32 AX
BT 40/ER 32 x 070 H	4140.13230	50	–	70	–	405	E 32
BT 40/ER 32 x 100 H	4140.13250	50	–	100	–	405	E 32
BT 40/ER 32 x 160 H	4140.13280	50	–	160	–	405/405	E 32
BT 40/ER 32 x 226 XL	8841.16050	50	55	226	140	–	E 32
BT 40/ER 32 x 326 XL	8841.16150	50	55	326	240	–	E 32
BT 40/ER 40 x 080	2140.14040	63	–	80	–	–	E 40
BT 40/ER 40 x 100 H	4140.14050	63	–	100	–	505	E 40
BT 40/ER 40 x 160 H	4140.14080	63	–	160	–	505/505	E 40

*Balancing rings

Included in delivery: ER toolholders come with HI-Q[®]/ER clamping nut. ERA toolholders come with HI-Q[®]/ERAX clamping nuts

H: Ready to accept balancing rings

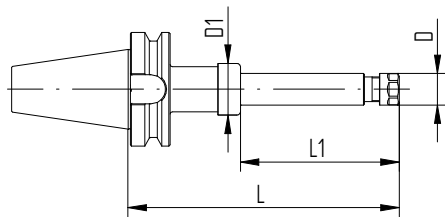

BT/ER XL

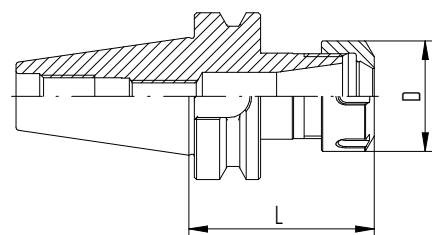

BT/ER (form A+AD)

BT/BT-B toolholders

BT
BT-B
MAS 403
JIS B 6339
DIN ISO 7388-2

Type	Part no.	Dimensions [mm]				Accessories	
		D	D1	L	L1	FWR*	Wrench
BT-B 40							
BT-B 40/ER 16 x 070 H	4140.11633	28	–	70	–	285	E 16 P
BT-B 40/ER 16 x 100 H	4140.11653	28	–	100	–	285	E 16 P
BT-B 40/ER 16 x 160 H	4140.11683	28	–	160	–	285/225	E 16 P
BT-B 40/ER 20 x 070 H	4140.12033	34	–	70	–	325	E 20 P
BT-B 40/ER 20 x 100 H	4140.12053	34	–	100	–	285	E 20 P
BT-B 40/ER 20 x 160 H	4140.12083	34	–	160	–	405/285	E 20 P
BT-B 40/ER 25 x 070 H	4140.12533	42	–	70	–	325	E 25
BT-B 40/ER 25 x 100 H	4140.12553	42	–	100	–	405	E 25
BT-B 40/ER 25 x 160 H	4140.12583	42	–	160	–	405/325	E 25
BT-B 40/ER 32 x 070 H	4140.13233	50	–	70	–	405	E 32
BT-B 40/ER 32 x 100 H	4140.13253	50	–	100	–	405	E 32
BT-B 40/ER 32 x 160 H	4140.13283	50	–	160	–	405/405	E 32
BT-B 40/ER 40 x 080	2140.14043	63	–	80	–	–	E 40
BT-B 40/ER 40 x 100 H	4140.14053	63	–	100	–	505	E 40
BT-B 40/ER 40 x 160 H	4140.14083	63	–	160	–	505/505	E 40
BT 50							
BT 50/ER 16 x 100 H	4150.11650	28	–	100	–	505	E 16 P
BT 50/ER 16 x 160 H	4150.11680	28	–	160	–	505/225	E 16 P
BT 50/ER 16 x 240 XL	8851.13070	28	46	240	140	–	E 16 P
BT 50/ER 16 x 260 XL	8851.13090	28	46	260	140	–	E 16 P
BT 50/ER 16 x 300 XL	8851.13130	28	46	300	140	–	E 16 P
BT 50/ER 16 x 340 XL	8851.13170	28	46	340	240	–	E 16 P
BT 50/ER 16 x 360 XL	8851.13190	28	46	360	240	–	E 16 P
BT 50/ER 16 x 400 XL	8851.13230	28	46	400	240	–	E 16 P
BT 50/ER 20 x 070	2150.12030	34	–	70	–	–	E 20 P
BT 50/ER 20 x 100 H	4150.12050	34	–	100	–	325	E 20 P
BT 50/ER 25 x 070	2150.12530	42	–	70	–	–	E 25
BT 50/ER 25 x 100 H	4150.12550	42	–	100	–	405	E 25
BT 50/ER 25 x 160 H	4150.12580	42	–	160	–	405/325	E 25
BT 50/ER 32 x 100 H	4150.13250	50	–	100	–	505	E 32
BT 50/ER 32 x 160 H	4150.13280	50	–	160	–	505/405	E 32
BT 50/ER 32 x 200 H	4150.13290	50	–	200	–	505/405	E 32
BT 50/ER 32 x 240 XL	8851.16070	50	55	240	140	–	E 32
BT 50/ER 32 x 340 XL	8851.16170	50	55	340	240	–	E 32
BT 50/ER 40 x 100 H	4150.14050	63	–	100	–	505	E 40
BT 50/ER 40 x 160 H	4150.14080	63	–	160	–	505/505	E 40
BT 50/ER 50 x 100	2150.15050	78	–	100	–	–	E 50

**Balancing rings*
Included in delivery: ER toolholders come with Hi-Q®/ER clamping nut. ERA toolholders come with Hi-Q®/ERAX clamping nuts
H: Ready to accept balancing rings

Type	Part no.	Dimensions [mm]				Accessories	
		D	D1	L	L1	FWR*	Wrench
BT-B 50							
BT-B 50/ER 16 x 100 H	4150.11653	28	–	100	–	505	E 16 P
BT-B 50/ER 16 x 160 H	4150.11683	28	–	160	–	505/225	E 16 P
BT-B 50/ER 20 x 070	2150.12033	34	–	70	–	–	E 20 P
BT-B 50/ER 20 x 100 H	4150.12053	34	–	100	–	325	E 20 P
BT-B 50/ER 25 x 070	2150.12533	42	–	70	–	–	E 25
BT-B 50/ER 25 x 100 H	4150.12553	42	–	100	–	405	E 25
BT-B 50/ER 25 x 160 H	4150.12583	42	–	160	–	405/325	E 25
BT-B 50/ER 32 x 100 H	4150.13253	50	–	100	–	505	E 32
BT-B 50/ER 32 x 160 H	4150.13283	50	–	160	–	505/405	E 32
BT-B 50/ER 40 x 100 H	4150.14053	63	–	100	–	505	E 40
BT-B 50/ER 40 x 160 H	4150.14083	63	–	160	–	505/505	E 40

*Balancing rings

Included in delivery: ER toolholders come with HI-Q®/ER clamping nut. ERA toolholders come with HI-Q®/ERAX clamping nuts

H: Ready to accept balancing rings

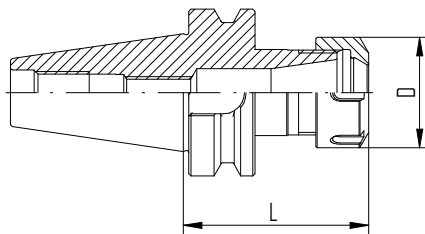

BT/ER (form A+AD)

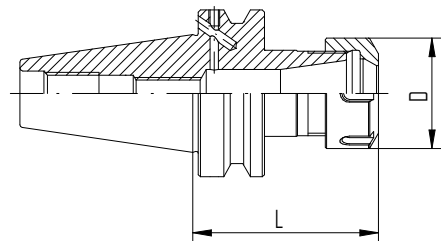

BT-B/ER (form AD+B)

Expert advice

What is the difference between form A+AD and AD+B?
 Form A+AD: coolant supply through the taper
 Form AD+B: coolant supply through the flange

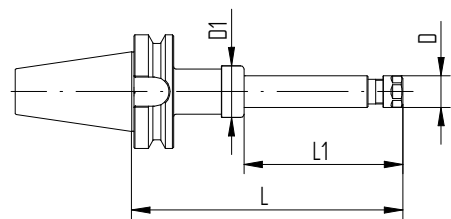

BT/ER XL

BT-OM toolholders

ERA Zero-Z® toolholder

BT-OM
 HAAS
 HURCO

Information

BT-OM/ER toolholders without drive slots

Applications

This special toolholder without drive slots is designed for use on HAAS and HURCO CNC-machining centers.

Special applications

When extra high clamping force is needed, e.g., when tapping with ER-GB, we recommend to use our friction-bearing clamping nuts Hi-Q®/ERB* and Hi-Q®/ERBC*.

**Not for use with ERA toolholders.*

Balancing

REGO-FIX BT-OM/ER(A) toolholders are balanced to G 2.5 @ 25,000 rpm/<1gmm. Type H toolholders are compatible with Hi-Q® balancing rings which allow precision balancing of the entire system including cutting tool up to 80,000 rpm depending on the balancing rings used.

Matched tooling system for best fit

For highest precision and best results the entire machining system counts. Therefore REGO-FIX components are carefully matched for optimum fit and accuracy. This guarantees the best runout and balance.

For the influence of runout on tool life, please refer to page 270.

Accessories are not included in delivery.

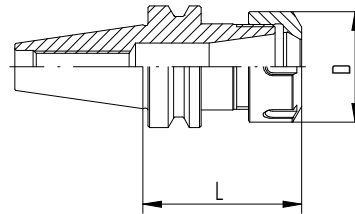

BT-OM/ER

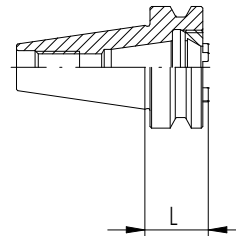

BT-OM/ERA

Type	Part no.	Dimensions [mm]				Accessories	
		D	D1	L	L1	FWR*	Wrench
BT-OM							
BT-OM 30/ER 16 x 080 H	4130.11648	28	–	80	–	285	E 16 P
BT-OM 30/ER 25 x 060 H	4130.12528	42	–	60	–	325	E 25
BT-OM 30/ER 32 x 060	2130.13228	50	–	60	–	–	E 32
BT-OM 30/ERA 20 x 022	2130.12008	–	–	22	–	–	E 20 AX

*Balancing rings

Included in delivery: ER toolholders come with Hi-Q®/ER clamping nut. ERA toolholders come with Hi-Q®/ERAX clamping nuts

H: Ready to accept balancing rings

REGO-FIX BT+ toolholders

Certified The BIG PLUS SYSTEM – licensed by BIG Daishowa – is manufactured at REGO-FIX in Switzerland under license according to BIG PLUS specifications.

Key advantages

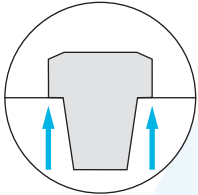

Higher toolholder stiffness due to taper (AT1) and face contact.

MAS 403 / JIS B 6339 / DIN ISO 7388-2

Features and benefits

Runout TIR $\leq 3 \mu\text{m}$

Measured from inner taper to outer taper.

Surface finish max. Ra 0.25

Better spindle-to-holder fit and accuracy.

Balancing

100% balanced to G 2.5 @ 25,000 rpm / <1gmm.

Hi-Q® balancing system

Ready to accept Hi-Q® balancing rings which allow for the offset of the imbalance introduced by the cutting tool up to 80,000 rpm depending on the balancing rings used. All toolholders with the additional type information "H" in the article name are designed for balancing rings.

Hi-Q®/ER clamping nut included in delivery

Guarantees highest clamping force and best balancing.

Vibration dampening

Our holders offer good vibration dampening to sustain a high surface finish and can help prevent chatter.



Accessories are not included in delivery. Form B available on request

Type	Part no.	Dimensions [mm]				Accessories	
		D	D1	L	L1	FWR*	Wrench
BT+ 30							
BT+ 30/ER 11 x 100 H	4130.11156	19	–	100	–	225	E 11 P
BT+ 30/ER 16 x 050	2130.11616	28	–	50	–	–	E 16 P
BT+ 30/ER 16 x 080 H	4130.11646	28	–	80	–	285	E 16 P
BT+ 30/ER 20 x 050	2130.12016	34	–	50	–	–	E 20 P
BT+ 30/ER 20 x 070 H	4130.12036	34	–	70	–	325	E 20 P
BT+ 30/ER 25 x 060 H	4130.12526	42	–	60	–	325	E 25
BT+ 30/ER 32 x 060	2130.13226	50	–	60	–	–	E 32
BT+ 40							
BT+ 40/ER 16 x 070 H	4140.11636	28	–	70	–	285	E 16 P
BT+ 40/ER 16 x 100 H	4140.11656	28	–	100	–	285	E 16 P
BT+ 40/ER 20 x 070 H	4140.12036	34	–	70	–	325	E 20 P
BT+ 40/ER 25 x 070 H	4140.12536	42	–	70	–	325	E 25
BT+ 40/ER 32 x 070 H	4140.13236	50	–	70	–	405	E 32
BT+ 40/ER 32 x 100 H	4140.13256	50	–	100	–	405	E 32
BT+ 40/ER 32 x 160 H	4140.13286	50	–	160	–	405/405	E 32
BT+ 50							
BT+ 50/ER 32 x 100 H	4150.13256	50	–	100	–	505	E 32
BT+ 50/ER 32 x 160 H	4150.13286	50	–	160	–	505/405	E 32

*Balancing rings H: Ready to accept balancing rings

Included in delivery: toolholders come with HI-Q®/ER clamping nut

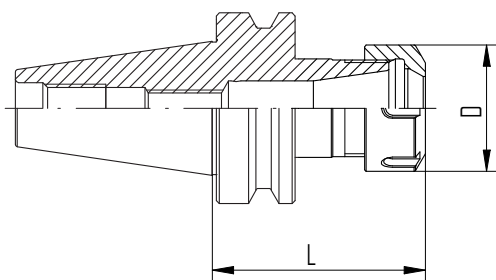

BT+ /ER (A+AD)

Steep taper toolholders CAT

Universally suitable for different machining applications.

ASME B5.50

Features and benefits

Runout $\leq 3 \mu\text{m}$

Measured from inner taper to outer taper.

Taper accuracy AT3

Better spindle-to-holder fit and accuracy.

Surface finish max. Ra 0.25

Achieve high clamping force and high transferable torque.

Balancing

100% balanced to G 2.5 @ 25,000 rpm.

Balancing in XL toolholders

100% balanced to G 2.5 @ 5,000 rpm.

Hi-Q® balancing system

Ready to accept Hi-Q® balancing rings which allow for the offset of the imbalance introduced by the cutting tool up to 80,000 rpm depending on the balancing rings used. All toolholders with the additional type information "H" in the article name are designed for balancing rings.

Hi-Q®/ER clamping nut included in delivery

Guarantees highest clamping force and best balancing.

Vibration dampening

Our holders offer good vibration dampening to sustain a high surface finish and can help prevent chatter.

Accessories are not included in delivery. Form B available on request



CAT toolholders

ERA Zero-Z[®] toolholder

CAT

ASME B5.50

Type	Part no.	Dimensions				Accessories	
		D [mm]	D1 [mm]	L [inch]	L1 [inch]	FWR*	Wrench
CAT 40							
CAT 40/ER 11 x 3" H	4340.11131	19	–	3	–	325	7112.11010
CAT 40/ER 11 x 6" H	4340.11171	19	–	6	–	325	7112.11010
CAT 40/ER 16 x 3" H	4340.11631	28	–	3	–	325	7112.16010
CAT 40/ER 16 x 4" H	4340.11651	28	–	4	–	285	7112.16010
CAT 40/ER 16 x 6" H	4340.11671	28	–	6	–	325/225	7112.16010
CAT 40/ER 16 x 8" XL	8843.13031	28	42	8	4	–	7112.16010
CAT 40/ER 16 x 10" XL	8843.13101	28	42	10	4	–	7112.16010
CAT 40/ER 16 x 12" XL	8843.13131	28	42	12	8	–	7112.16010
CAT 40/ER 16 x 14" XL	8843.13181	28	42	14	8	–	7112.16010
CAT 40/ER 20 x 3" H	4340.12031	34	–	3	–	285	7112.20010
CAT 40/ER 20 x 4" H	4340.12051	34	–	4	–	325	7112.20010
CAT 40/ER 20 x 6" H	4340.12071	34	–	6	–	405/285	7112.20010
CAT 40/ER 25 x 4" H	4340.12551	42	–	4	–	325	7111.25000
CAT 40/ER 25 x 6" H	4340.12571	42	–	6	–	405/325	7111.25000
CAT 40/ERA 32 x 019 mm	2340.13200	35	–	19 mm	–	–	7111.32000
CAT 40/ER 32 x 3" H	4340.13231	50	–	3	–	405	7111.32000
CAT 40/ER 32 x 4" H	4340.13251	50	–	4	–	405	7111.32000
CAT 40/ER 32 x 5" H	4340.13261	50	–	5	–	405	7111.32000
CAT 40/ER 32 x 6" H	4340.13271	50	–	6	–	405/405	7111.32000
CAT 40/ER 32 x 10" XL	8843.16081	50	52	10	4	–	7111.32000
CAT 40/ER 32 x 14" XL	8843.16141	50	52	14	8	–	7111.32000
CAT 40/ER 40 x 3.5" H	4340.14041	63	–	3.5	–	505	7111.40000
CAT 40/ER 40 x 6" H	4340.14071	63	–	6	–	505/505	7111.40000

*Balancing rings

Included in delivery: ER toolholders come with Hi-Q[®]/ER clamping nut. ERA toolholders come with Hi-Q[®]/ERA clamping nuts

H: Ready to accept balancing rings

Type	Part no.	Dimensions				Accessories	
		D [mm]	D1 [mm]	L [inch]	L1 [inch]	FWR*	Wrench
CAT-B 40							
CAT-B 40/ER 11 x 3" H	4340.11134	19	-	3	-	325	7112.11010
CAT-B 40/ER 11 x 6" H	4340.11174	19	-	6	-	325	7112.11010
CAT-B 40/ER 16 x 3" H	4340.11634	28	-	3	-	325	7112.16010
CAT-B 40/ER 16 x 4" H	4340.11654	28	-	4	-	285	7112.16010
CAT-B 40/ER 16 x 6" H	4340.11674	28	-	6	-	325/225	7112.16010
CAT-B 40/ER 20 x 3" H	4340.12034	34	-	3	-	285	7112.20010
CAT-B 40/ER 20 x 4" H	4340.12054	34	-	4	-	325	7112.20010
CAT-B 40/ER 20 x 6" H	4340.12074	34	-	6	-	405/285	7112.20010
CAT-B 40/ER 25 x 4" H	4340.12554	42	-	4	-	325	7111.25000
CAT-B 40/ER 25 x 6" H	4340.12574	42	-	6	-	405/325	7111.25000
CAT-B 40/ER 32 x 3" H	4340.13234	50	-	3	-	405	7111.32000
CAT-B 40/ER 32 x 4" H	4340.13254	50	-	4	-	405	7111.32000
CAT-B 40/ER 32 x 5" H	4340.13264	50	-	5	-	405	7111.32000
CAT-B 40/ER 32 x 6" H	4340.13274	50	-	6	-	405/405	7111.32000
CAT-B 40/ER 40 x 3.5" H	4340.14044	63	-	3.5	-	505	7111.40000
CAT-B 40/ER 40 x 6" H	4340.14074	63	-	6	-	505/505	7111.40000

*Balancing rings

Included in delivery: ER toolholders come with Hi-Q®/ER clamping nut. ERA toolholders come with Hi-Q®/ERA clamping nuts

H: Ready to accept balancing rings

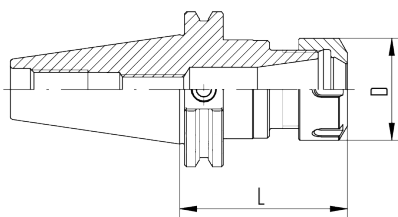

CAT/ER (Form A+AD)

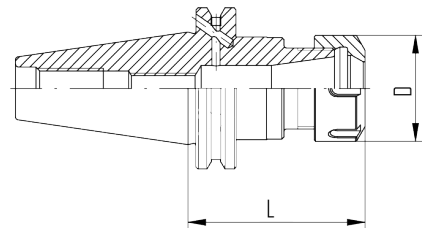

CAT-B/ER (Form AD+B)

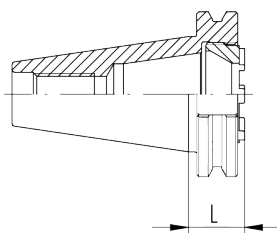

CAT/ERA

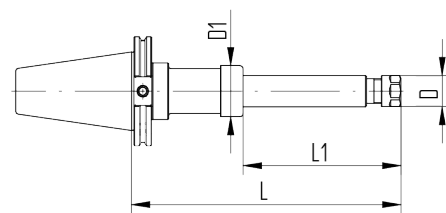

CAT/ER XL (Form A+AD)

CAT toolholders

CAT-B toolholders

CAT

CAT-B

Type	Part no.	Dimensions				Accessories	
		D [mm]	D1 [mm]	L [inch]	L1 [inch]	FWR*	Wrench
CAT 50							
CAT 50/ER 16 x 4" H	4350.11651	28		4		505	7112.16010
CAT 50/ER 16 x 6" H	4350.11671	28		6		505/225	7112.16010
CAT 50/ER 16 x 8" XL	8853.13031	28	42	8	4		7112.16010
CAT 50/ER 16 x 10" XL	8853.13081	28	42	10	4		7112.16010
CAT 50/ER 16 x 12" XL	8853.13131	28	42	12	8		7112.16010
CAT 50/ER 16 x 14" XL	8853.13181	28	42	14	8		7112.16010
CAT 50/ER 20 x 4" H	4350.12051	34		4		505	7112.20010
CAT 50/ER 20 x 6" H	4350.12071	34		6		505/285	7112.20010
CAT 50/ER 25 x 4" H	4350.12551	42		4		505	7111.25000
CAT 50/ER 25 x 6" H	4350.12571	42		6		505/325	7111.25000
CAT 50/ER 32 x 4" H	4350.13251	50		4		505	7111.32000
CAT 50/ER 32 x 6" H	4350.13271	50		6		505/405	7111.32000
CAT 50/ER 32 x 10" XL	8853.16081	50	52	10	4		7111.32000
CAT 50/ER 32 x 14" XL	8853.16181	50	52	14	8		7111.32000
CAT 50/ERA 40 x 019 mm	2350.14007	44		19 mm			7117.40000
CAT 50/ER 40 x 4" H	4350.14051	63		4		505	7111.40000
CAT 50/ER 40 x 6" H	4350.14071	63		6		505/505	7111.40000
CAT-B 50							
CAT-B 50/ER 16 x 4" H	4350.11654	28		4		505	7112.16010
CAT-B 50/ER 16 x 6" H	4350.11674	28		6		505/225	7112.16010
CAT-B 50/ER 20 x 4" H	4350.12054	34		4		505	7112.20010
CAT-B 50/ER 20 x 6" H	4350.12074	34		6		505/285	7112.20010
CAT-B 50/ER 25 x 4" H	4350.12554	42		4		505	7111.25000
CAT-B 50/ER 25 x 6" H	4350.12574	42		6		505/325	7111.25000
CAT-B 50/ER 32 x 4" H	4350.13254	50		4		505	7111.32000
CAT-B 50/ER 32 x 6" H	4350.13274	50		6		505/405	7111.32000
CAT-B 50/ER 40 x 4" H	4350.14054	63		4		505	7111.40000
CAT-B 50/ER 40 x 6" H	4350.14074	63		6		505/505	7111.40000

*Balancing rings

Included in delivery: ER toolholders come with Hi-Q®/ER clamping nut. ERA toolholders come with Hi-Q®/ERA clamping nuts

H: Ready to accept balancing rings

Expert advice

For additional technical drawings and details, see the REGO-FIX website at www.rego-fix.com.

REGO-FIX CAT+ toolholders

Certified The BIG PLUS SYSTEM – licensed by BIG Daishowa – is manufactured at REGO-FIX in Switzerland under license according to BIG PLUS specifications.

Key advantages

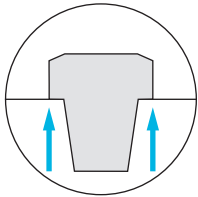

Higher toolholder stiffness due to taper (AT1) and face contact

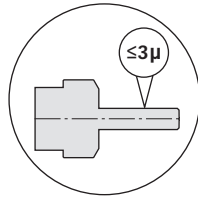

Improved machining accuracy and better surface finish

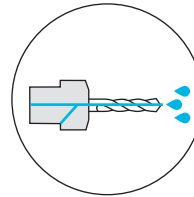

Form AD+B as standard configuration

Type	Part no. AD+B	Dimensions				Accessories	
		D [mm]	D1	L [inch]	L1	FWR*	Wrench
CAT+ 40**							
CAT+ 40/ER 11 x 3" H	4340.11136	19	–	3	–	285	7112.11010
CAT+ 40/ER 16 x 3" H	4340.11636	28	–	3	–	325	7112.16010
CAT+ 40/ER 16 x 6" H	4340.11676	28	–	6	–	325/225	7112.16010
CAT+ 40/ER 20 x 3" H	4340.12036	34	–	3	–	285	7112.20010
CAT+ 40/ER 20 x 6" H	4340.12076	34	–	6	–	405/285	7112.20010
CAT+ 40/ER 25 x 4" H	4340.12556	42	–	4	–	325	7111.25000
CAT+ 40/ER 25 x 6" H	4340.12576	42	–	6	–	405/325	7111.25000
CAT+ 40/ER 32 x 3" H	4340.13236	50	–	3	–	405	7111.32000
CAT+ 40/ER 32 x 6" H	4340.13276	50	–	6	–	405/405	7111.32000
CAT+ 50**							
CAT+ 50/ER 16 x 4" H	4350.11656	28	–	4	–	505	7112.16010
CAT+ 50/ER 16 x 6" H	4350.11676	28	–	6	–	505/225	7112.16010
CAT+ 50/ER 20 x 4" H	4350.12056	34	–	4	–	505	7112.20010
CAT+ 50/ER 25 x 4" H	4350.12556	42	–	4	–	505	7111.25000
CAT+ 50/ER 32 x 4" H	4350.13256	50	–	4	–	505	7111.32000
CAT+ 50/ER 32 x 6" H	4350.13276	50	–	6	–	505/405	7111.32000
CAT+ 50/ER 40 x 4" H	4350.14056	63	–	4	–	505	7111.40000

*Balancing rings

Included in delivery: ER toolholders come with Hi-Q®/ER clamping nut. ERA toolholders come with Hi-Q®/ERA clamping nuts

**USA only

H: Ready to accept balancing rings



REGO-FIX CAPTO toolholders

These self-centering and balanced toolholders enable high-torque transmission and show a high-bending strength.

ISO 12164

Features and benefits

Runout TIR $\leq 3 \mu\text{m}$

Measured from inner taper to outer taper.

Surface finish max. Ra 0.25

Achieve high clamping force and high transferable torque.

Balancing

100% balanced to G 2.5 @ 25,000 rpm / <1gmm.

XL toolholders

100% balanced to G 2.5 @ 5,000 rpm.
TIR from inner to outer taper <10 μm .

Hi-Q® balancing system

Ready to accept Hi-Q® balancing rings which allow for the offset of the imbalance introduced by the cutting tool up to 80,000 rpm depending on the balancing rings used. All toolholders with the additional type information "H" in the article name are designed for balancing rings.

Hi-Q®/ER clamping nut included in delivery

Guarantees highest clamping force and best balancing.

Vibration dampening

Our holders offer good vibration dampening to sustain a high surface finish and can help prevent chatter.

Certified REGO-FIX CAPTO – licensed by Sandvik Coromant – is manufactured at REGO-FIX Switzerland under license according to CAPTO specifications.



*Accessories are not included in delivery. Other XL sizes available on request
All REGO-FIX CAPTO toolholders are available with chip hole on request*

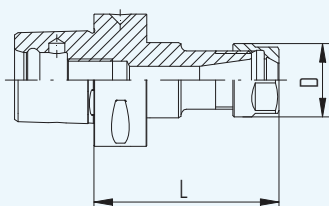

C/ER

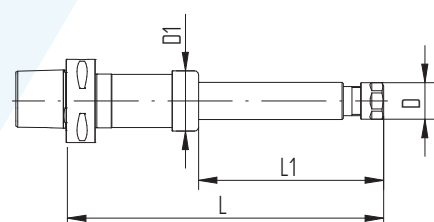

C/ER XL

Type	Part no.	Dimensions [mm]				Accessories	
		D	D1	L	L1	FWR*	Wrench
C3							
C3/ER 16 x 045	2803.11610	28	–	45	–	–	E 16 P
C3/ER 20 x 045	2803.12010	34	–	45	–	–	E 20 P
C4							
C4/ER 16 x 070	2804.11630	28	–	70	–	–	E 16 P
C4/ER 20 x 052	2804.12010	34	–	52	–	–	E 20 P
C4/ER 25 x 052	2804.12510	42	–	52	–	–	E 25
C4/ER 32 x 054	2804.13210	50	–	54	–	–	E 32
C5							
C5/ER 16 x 070 H	4805.11630	28	–	70	–	285	E 16 P
C5/ER 16 x 100 H	4805.11650	28	–	100	–	285	E 16 P
C5/ER 20 x 055	2805.12010	34	–	55	–	–	E 20 P
C5/ER 20 x 100 H	4805.12050	34	–	100	–	325	E 20 P
C5/ER 25 x 055	2805.12510	42	–	55	–	–	E 25
C5/ER 25 x 100 H	4805.12550	42	–	100	–	405	E 25
C5/ER 32 x 057	2805.13210	50	–	57	–	–	E 32
C5/ER 32 x 070 H	4805.13230	50	–	70	–	405	E 32
C5/ER 32 x 100H	4805.13250	50	–	100	–	405	E 32
C6							
C6/ER 11 x 150 H	4806.11170	19	–	150	–	325	E 11 P
C6/ER 16 x 070 H	4806.11630	28	–	70	–	325	E 16 P
C6/ER 16 x 100 H	4806.11650	28	–	100	–	325	E 16 P
C6/ER 16 x 150 H	4806.11670	28	–	150	–	325	E 16 P
C6/ER 16 x 225 XL	8886.13050	28	46	225	140	–	E 16 P
C6/ER 16 x 240 XL	8886.13070	28	46	240	140	–	E 16 P
C6/ER 16 x 260 XL	8886.13090	28	46	260	140	–	E 16 P
C6/ER 16 x 300 XL	8886.13130	28	46	300	140	–	E 16 P
C6/ER 16 x 325 XL	8886.13150	28	46	325	240	–	E 16 P
C6/ER 16 x 340 XL	8886.13170	28	46	340	240	–	E 16 P
C6/ER 16 x 360 XL	8886.13190	28	46	360	240	–	E 16 P
C6/ER 16 x 400 XL	8886.13230	28	46	400	240	–	E 16 P
C6/ER 20 x 060	2806.12020	34	–	60	–	–	E 20 P

*Balancing rings H: Ready to accept balancing rings

Included in delivery: toolholders come with HI-Q®/ER clamping nut

All REGO-FIX CAPTO toolholders are available with chip hole on request.

Type	Part no.	Dimensions [mm]				Accessories	
		D	D1	L	L1	FWR*	Wrench
C6 continued							
C6/ER 25 x 060	2806.12520	42	–	60	–	–	E 25
C6/ER 25 x 100 H	4806.12550	42	–	100	–	405	E 25
C6/ER 25 x 130 H	4806.12560	42	–	130	–	405	E 25
C6/ER 32 x 060	2806.13220	50	–	60	–	–	E 32
C6/ER 32 x 070 H	4806.13230	50	–	70	–	405	E 32
C6/ER 32 x 100 H	4806.13250	50	–	100	–	505	E 32
C6/ER 32 x 230 XL	8886.16060	50	55	230	140	–	E 32
C6/ER 32 x 330 XL	8886.16160	50	55	330	240	–	E 32
C6/ER 40 x 065	2806.14020	63	–	65	–	–	E 40

C8							
C8/ER 16 x 232 XL	8888.13060	28	46	232	140	–	E 16 P
C8/ER 16 x 332 XL	8888.13160	28	46	332	240	–	E 16 P
C8/ER 25 x 070	2808.12530	42	–	70	–	–	E 25
C8/ER 32 x 070	2808.13230	50	–	70	–	–	E 32
C8/ER 32 x 230 XL	8888.16060	50	55	230	140	–	E 32
C8/ER 32 x 330 XL	8888.16160	50	55	330	240	–	E 32
C8/ER 40 x 070	2808.14030	63	–	70	–	–	E 40
C8/ER 50 x 080	2808.15040	78	–	80	–	–	E 50

*Balancing rings H: Ready to accept balancing rings

Included in delivery: toolholders come with Hi-Q®/ER clamping nut

All REGO-FIX CAPTO toolholders are available with chip hole on request



Expert advice

We recommend tightening the clamping nuts with our TORCO-BLOCK or torque wrench. Get the best accuracy by respecting the suitable tightening forces.

For more information on TORCO-BLOCK, see page 262.

For tightening torque recommendations, please refer to page 293.

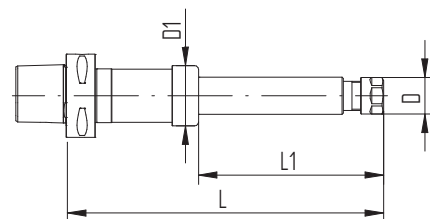



Cylindrical shank toolholders CYL

CYL/CYLF/CYDF

Features and benefits

Runout TIR $\leq 3 \mu\text{m}$ for CYL/ERM and CYL/ERMX

Measured from inner taper to outer shank.

Runout TIR $\leq 5 \mu\text{m}$ for CYLF/ERM and CYLF/ERMX

Measured from inner taper to outer shank.

Runout TIR $\leq 5 \mu\text{m}$ for CYDF/ERM and CYDF/ERMX

Measured from inner taper to outer shank.

Surface finish max. Ra 0.25

Achieve high clamping force and high transferable torque.

Sizes

ER 8–ER 40
h6 tolerance on shanks.

Types

- // With or without clamping flat
- // Double ER holders

Accessories are not included in delivery

Expert advice

We recommend tightening the clamping nuts with our torque wrench.

For tightening torque recommendations, please refer to page 293.



Available CYL toolholders and their key characteristics

Cylindrical REGO-FIX toolholders are designed for automatic turning machines and can also be utilized as extensions. We offer many different product types to fit your machining needs.

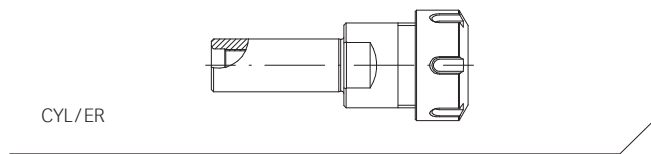

CYL/ER The short versions are particularly used on turret lathes, where a short overhang is often required.
For technical dimensions, please refer to page 100.

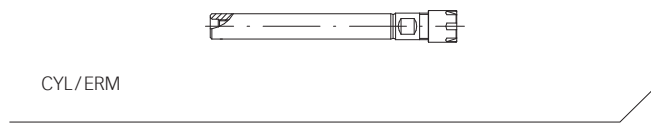

CYL/ERM This type is suited for Swiss automatic machines, machining centers and conventional machines. Can be used as extension.
For technical dimensions, please refer to page 102.



CYL/ERMX This type is suited for Swiss automatic machines, machining centers and conventional machines. The slip-off proof mini clamping nut intRlox® prevents injuries caused by slipping off while tightening the nut. Can be used as extension.
For technical dimensions, please refer to page 102.

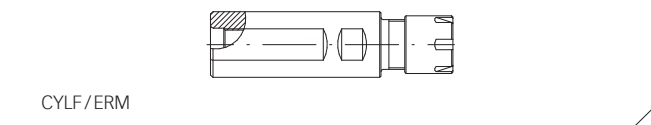

CYLF/ERM The line of cylindrical toolholders with clamping flat is particularly designed for Swiss automatic CNC machines, e.g., Citizen, Manurhin, Star or Tornos. Cannot be used as extension.
For technical dimensions, please refer to page 104.

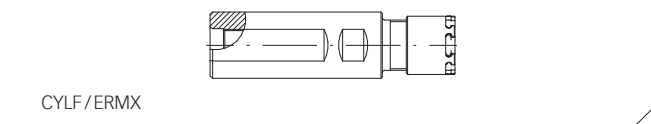

CYLF/ERMX The line of cylindrical toolholders with clamping flat is particularly designed for Swiss automatic CNC machines, e.g., Citizen, Manurhin, Star or Tornos. The slip-off proof mini clamping nut intRlox® prevents injuries caused by slipping off while tightening the nut. Cannot be used as extension.
For technical dimensions, please refer to page 104.

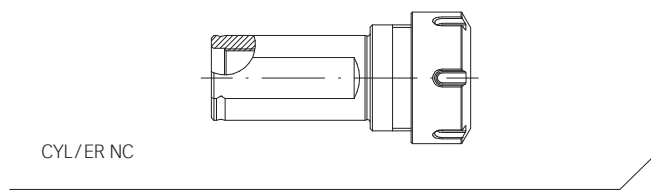

CYL/ER NC These toolholders are particularly suitable on Swiss automatic CNC turning machines, but can also be used on other turning machines.
For technical dimensions, please refer to page 107.

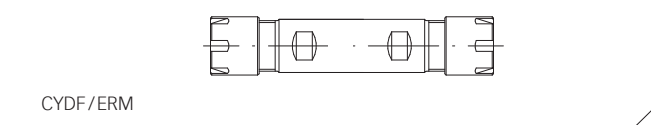

CYDF/ERM The line of double toolholders with clamping flat has been designed for Swiss automatic CNC machines, e.g., Citizen, Manurhin, Star or Tornos and offers the possibility to hold two cutting tools on the same toolholder.
For technical dimensions, please refer to page 108.

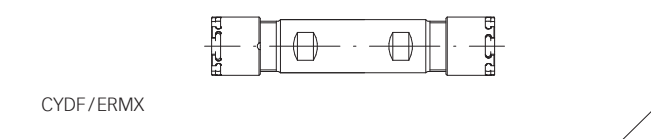

CYDF/ERMX The line of double toolholders with clamping flat has been designed for Swiss Automatic CNC machines, e.g., Citizen, Manurhin, Star or Tornos, and offers the possibility to hold two cutting tools on the same toolholder. The slip-off proof mini clamping nut intRlox® prevents injuries caused by slipping off while tightening the nut.
For technical dimensions, please refer to page 108.

Type	Part no.	Dimensions [mm]						Accessory	
		D	D1 h6	L	L1	G1	G2	Wrench	
CYL 1/2 [inch]									
CYL 1/2" x 070/ER 11	2613.11141	19	12.7	70	28.5	M 6	M 6	E 11 P	
CYL 1/2" x 100/ER 16	2613.11661	28	12.7	100	36	M 6	M 6	E 16 P	
CYL 1/2" x 100/ER 20	2613.12061	34	12.7	100	44.5	M 6	M 6	E 20 P	
CYL 14 [mm]									
CYL 14 x 060/ER 16	2614.11630	28	14	60	36.5	M 6	M 6	E 16 P	
CYL 16 [mm]									
CYL 16 x 060/ER 16	2616.11630	28	16	60	36.5	M 8 x 1	–	E 16 P	
CYL 5/8 [inch]									
CYL 5/8" x 060/ER 16	2616.11631	28	15.875	60	36.5	M 8 x 1	–	E 16 P	
CYL 5/8" x 100/ER 20	2616.12061	34	15.875	100	44.5	M 8 x 1	M 8 x 1	E 20 P	
CYL 3/4 [inch]									
CYL 3/4" x 050/ER 16	2619.11621	28	19.05	50	30.5	M 12 x 1	–	E 16 P	
CYL 3/4" x 100/ER 16	2619.11661	28	19.05	100	30.5	M 12 x 1	M 11 x 1	E 16 P	
CYL 3/4" x 060/ER 20	2619.12031	34	19.05	60	36.5	M 12 x 1	–	E 20 P	
CYL 3/4" x 050/ER 25	2619.12521	42	19.05	50	47	M 12 x 1	–	E 25	
CYL 20 [mm]									
CYL 20 x 050/ER 16	2620.11620	28	20	50	30.5	M 12 x 1	–	E 16 P	
CYL 20 x 100/ER 16	2620.11660	28	20	100	30.5	M 12 x 1	M 11 x 1	E 16 P	
CYL 20 x 030/ER 20	2620.12010	34	20	30	36.5	M 12 x 1	–	E 20 P	
CYL 20 x 060/ER 20	2620.12030	34	20	60	36.5	M 12 x 1	–	E 20 P	
CYL 20 x 050/ER 25	2620.12520	42	20	50	47	M 12 x 1	–	E 25	
CYL 20 x 100/ER 25	2620.12560	42	20	100	47	M 12 x 1	M 12 x 1	E 25	
CYL 20 x 050/ER 32	2620.13220	50	20	50	54	M 12 x 1	–	E 32	
CYL 20 x 100/ER 32	2620.13260	50	20	100	54	M 12 x 1	M 12 x 1	E 32	
CYL 25 [mm]									
CYL 25 x 050/ER 25	2625.12520	42	25	50	47	M 18 x 1.5	–	E 25	
CYL 25 x 100/ER 25	2625.12560	42	25	100	47	M 18 x 1.5	M 18 x 1.5	E 25	
CYL 25 x 050/ER 32	2625.13220	50	25	50	54	M 18 x 1.5	–	E 32	
CYL 25 x 050/ER 40	2625.14020	63	25	50	60	M 18 x 1.5	–	E 40	

Included in delivery: toolholders come with HI-Q®/ER clamping nut and back-up screw

Type	Part no.	Dimensions [mm]						Accessory	
		D	D1 h6	L	L1	G1	G2	Wrench	
CYL 1 [inch]									
CYL 1" x 100/ER 20	2625.12061	34	25.4	100	39.5	M 14 x 1	M 14 x 1	E 20 P	
CYL 1" x 050/ER 25	2625.12521	42	25.4	50	47	M 18 x 1.5	–	E 25	
CYL 1" x 100/ER 25	2625.12561	42	25.4	100	47	M 18 x 1.5	M 18 x 1.5	E 25	
CYL 1" x 050/ER 32	2625.13221	50	25.4	50	53	M 18 x 1.5	–	E 32	
CYL 1" x 050/ER 40	2625.14021	63	25.4	50	60	M 18 x 1.5	–	E 40	
CYL 30 [mm]									
CYL 30 x 050/ER 25	2630.12520	42	30	50	42	M 18 x 1.5	–	E 25	
CYL 1 1/4 [inch]									
CYL 1 1/4" x 060/ER 32	2632.13231	50	31.75	60	53	M 22 x 1.5	–	E 32	

Included in delivery: toolholders come with Hi-Q®/ER clamping nut and back-up screw



CYL/ER

Coolant adapters*

CGA M 12 x 1 / 1/8" NPT	7239.12181
CGA M 14 x 1 / 1/4" NPT	7239.14141
CGA M 18 x 1.5 / 1/4" NPT	7239.18141
CGA M 22 x 1.5 / 1/4" NPT	7239.22141

Converts back-up screw threads to coolant port for through coolant applications
*USA only

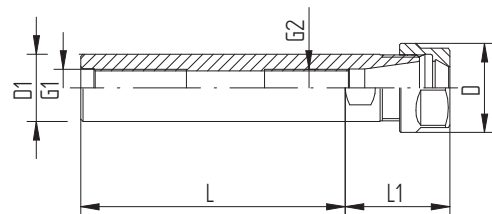

CYL/ER

CYL/ERM toolholders (mini clamping nut)

CYL

CYL/ERMX toolholders with intrRlox® (slip-off proof mini clamping nut)

Type	Part no.	Dimensions [mm]					G1	G2	Slip-off proof	Accessory
		D	D1 h6	L	L1	Wrench				
CYL 6 [mm]										
CYL 6 x 045/ERM 11	2606.21120	16	6	45	26.5	–	–	–	E 11 M	
CYL 6 x 045/ERMX 11	4606.21120	16	6	45	26.5	–	–	•	E 11 MX	
CYL 7 [mm]										
CYL 7 x 045/ERM 11	2607.21120	16	7	45	26.5	–	–	–	E 11 M	
CYL 7 x 045/ERMX 11	4607.21120	16	7	45	26.5	–	–	•	E 11 MX	
CYL 8 [mm]										
CYL 8 x 080/ERM 8	2608.20850	12	8	80	26	M 5	–	–	E 8 M	
CYL 8 x 080/ERMX 8	4608.20850	12	8	80	26	M 5	–	•	E 8 MX	
CYL 8 x 056/ERM 11	2608.21130	16	8	56	26.5	M 5	–	–	E 11 M	
CYL 8 x 056/ERMX 11	4608.21130	16	8	56	26.5	M 5	–	–	E 11 MX	
CYL 3/8 [inch]										
CYL 3/8" x 070/ERM 8	2609.20841	12	9.525	70	23	M 5	M 5	–	E 8 M	
CYL 3/8" x 070/ERMX 8	4609.20841	12	9.525	70	23	M 5	M 5	•	E 8 MX	
CYL 10 [mm]										
CYL 10 x 060/ERM 16	2610.21630	22	10	60	38.5	M 5	–	–	E 16 M	
CYL 10 x 060/ERMX 16	4610.21630	22	10	60	38.5	M 5	–	•	E 16 MX	
CYL 12 [mm]										
CYL 12 x 080/ERM 8	2612.20850	12	12	80	17	M 5	–	–	E 8 M	
CYL 12 x 080/ERMX 8	4612.20850	12	12	80	17	M 5	–	•	E 8 MX	
CYL 12 x 080/ERM 16	2612.21650	22	12	80	38.5	M 5	–	–	E 16 M	
CYL 12 x 080/ERMX 16	4612.21650	22	12	80	38.5	M 5	–	•	E 16 MX	
CYL 1/2 [inch]										
CYL 1/2" x 140/ERM 11	2613.21191	16	12.7	140	29.5	M 6	M 6	–	E 11 M	
CYL 1/2" x 140/ERMX 11	4613.21191	16	12.7	140	29.5	M 6	M 6	•	E 11 MX	
CYL 1/2" x 140/ERM 16	2613.21691	22	12.7	140	37	M 6	M 6	–	E 16 M	
CYL 1/2" x 140/ERMX 16	4613.21691	22	12.7	140	37	M 6	M 6	•	E 16 MX	
CYL 16 [mm]										
CYL 16 x 150/ERM 11	2616.21190	16	16	150	21	M 8 x 1	M 8 x 1	–	E 11 M	
CYL 16 x 150/ERMX 11	4616.21190	16	16	150	21	M 8 x 1	M 8 x 1	•	E 11 MX	
CYL 16 x 100/ERM 20	2616.22060	28	16	100	42.5	M 8 x 1	–	–	E 20 M	
CYL 16 x 100/ERMX 20	4616.22060	28	16	100	42.5	M 8 x 1	–	•	E 20 MX	

CYL/ERM toolholders (mini clamping nut)

CYL

CYL/ERMX toolholders with intRlox® (slip-off proof mini clamping nut)

Type	Part no.	Dimensions [mm]					G1	G2	Slip-off proof	Accessory Wrench
		D	D1 h6	L	L1					
CYL 5/8 [inch]										
CYL 5/8" x 150/ERM 11	2616.21191	16	15.875	150	19.5	M 8 x 1	M 8 x 1	–	E 11 M	
CYL 5/8" x 150/ERMX 11	4616.21191	16	15.875	150	19.5	M 8 x 1	M 8 x 1	•	E 11 MX	
CYL 3/4 [inch]										
CYL 3/4" x 155/ERM 16	2619.21691	22	19.05	155	26.5	M 12 x 1	–	–	E 16 M	
CYL 3/4" x 155/ERMX 16	4619.21691	22	19.05	155	26.5	M 12 x 1	–	•	E 16 MX	
CYL 3/4" x 100/ERM 25	2619.22561	35	19.05	100	47	M 12 x 1	M 12 x 1	–	E 25 M	
CYL 3/4" x 100/ERMX 25	4619.22561	35	19.05	100	47	M 12 x 1	M 12 x 1	•	E 25 MX	
CYL 20 [mm]										
CYL 20 x 155/ERM 16	2620.21690	22	20	155	25.5	M 12 x 1	M 11 x 1	–	E 16 M	
CYL 20 x 155/ERMX 16	4620.21690	22	20	155	25.5	M 12 x 1	M 11 x 1	•	E 16 MX	
CYL 25 [mm]										
CYL 25 x 155/ERM 20	2625.22090	28	25	155	27	M 14 x 1	M 14 x 1	–	E 20 M	
CYL 25 x 155/ERMX 20	4625.22090	28	25	155	27	M 14 x 1	M 14 x 1	•	E 20 MX	
CYL 1 [inch]										
CYL 1" x 155/ERM 20	2625.22091	28	25.4	155	27	M 14 x 1	M 14 x 1	–	E 20 M	
CYL 1" x 155/ERMX 20	4625.22091	28	25.4	155	27	M 14 x 1	M 14 x 1	•	E 20 MX	

Included in delivery: toolholders come with Hi-Q®/ERM or Hi-Q®/ERMX clamping nut and back-up screw

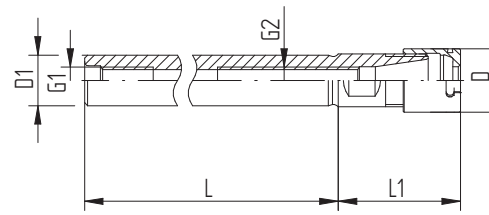
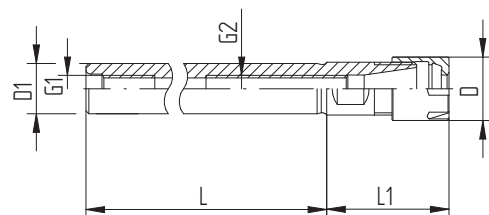

CYLF/ERM toolholders (mini clamping nut)

CYLF

CYLF/ERMX toolholders with intRlox® (slip-off proof mini clamping nut)

Type	Part no.	Dimensions [mm]					G1	G2	Slip-off proof	Accessory
		D	D1 h6	L	L1	Wrench				
CYLF 12 [mm]										
CYLF 12 x 043/ERM 8	2612.20822	12	12	43	17	M 5	–	–	E 8 M	
CYLF 12 x 043/ERMX 8	4612.20822	12	12	43	17	M 5	–	•	E 8 MX	
CYLF 5/8 [inch]										
CYLF 5/8" x 043/ERM 8	2616.20811	12	15.875	43	15.5	M 5	M 5	–	E 8 M	
CYLF 5/8" x 043/ERMX 8	4616.20811	12	15.875	43	15.5	M 5	M 5	•	E 8 MX	
CYLF 16 [mm]										
CYLF 16 x 038/ERM 11	2616.21112	16	16	38	19.5	M 8 x 1	–	–	E 11 M	
CYLF 16 x 038/ERMX 11	4616.21112	16	16	50	16	M 8 x 1	–	•	E 11 MX	
CYLF 16 x 050/ERM 11	2616.21122	16	16	50	16	M 8 x 1	–	–	E 11 M	
CYLF 16 x 050/ERMX 11	4616.21122	16	16	50	16	M 8 x 1	–	•	E 11 MX	
CYFL 16 x 140/ERM 11	2616.21192	16	16	140	19.5	M 8 x 1	M 8 x 1	–	E 11 M	
CYFL 16 x 140/ERMX 11	4616.21192	16	16	140	19.5	M 8 x 1	M 8 x 1	•	E 11 MX	
CYLF 16 x 035/ERM 16	2616.21612	22	16	35	36	M 8 x 1	–	–	E 16 M	
CYLF 16 x 035/ERMX 16	4616.21612	22	16	35	36	M 8 x 1	–	•	E 16 MX	
CYLF 3/4 [inch]										
CYLF 3/4" x 115/ERM 11	2619.21173	16	19.05	115	19.5	M 8 x 1	M 8 x 1	–	E 11 M	
CYLF 3/4" x 115/ERMX 11	4619.21173	16	19.05	115	19.5	M 8 x 1	M 8 x 1	•	E 11 MX	
CYLF 3/4" x 038/ERM 16	2619.21613	22	19.05	38	27.5	M 12 x 1	–	–	E 16 M	
CYLF 3/4" x 038/ERMX 16	4619.21613	22	19.05	38	27.5	M 12 x 1	–	•	E 16 MX	
CYLF 3/4" x 050/ERM 16	2619.21623	22	19.05	50	25	M 12 x 1	–	–	E 16 M	
CYLF 3/4" x 050/ERMX 16	4619.21623	22	19.05	50	25	M 12 x 1	–	•	E 16 MX	
CYLF 3/4" x 070/ERM 16	2619.21643	22	19.05	70	29.5	M 12 x 1	–	–	E 16 M	
CYLF 3/4" x 070/ERMX 16	4619.21643	22	19.05	70	29.5	M 12 x 1	–	•	E 16 MX	
CYLF 3/4" x 120/ERM 16	2619.21683	22	19.05	120	27.5	M 12 x 1	M 11 x 1	–	E 16 M	
CYLF 3/4" x 120/ERMX 16	4619.21683	22	19.05	120	27.5	M 12 x 1	M 11 x 1	•	E 16 MX	
CYLF 3/4" x 140/ERM 16	2619.21693	22	19.05	140	27.5	M 12 x 1	M 11 x 1	–	E 16 M	
CYLF 3/4" x 140/ERMX 16	4619.21693	22	19.05	140	27.5	M 12 x 1	M 11 x 1	•	E 16 MX	

Included in delivery: toolholders come with Hi-Q®/ERM or Hi-Q®/ERMX clamping nut and back-up screw

CYLF/ERM toolholders (mini clamping nut)

CYLF

CYLF/ERMX toolholders with intrRlox® (slip-off proof mini clamping nut)

Type	Part no.	Dimensions [mm]					G1	G2	Slip-off proof	Accessory Wrench
		D	D1 h6	L	L1					
CYLF 20 [mm]										
CYLF 20 x 060/ERM 11	2620.21132	16	20	60	19.5	M 8 x 1	–	–	–	E 11 M
CYLF 20 x 060/ERMX 11	4620.21132	16	20	60	19.5	M 8 x 1	–	•	–	E 11 MX
CYLF 20 x 038/ERM 16	2620.21612	22	20	38	26.5	M 12 x 1	–	–	–	E 16 M
CYLF 20 x 038/ERMX 16	4620.21612	22	20	38	26.5	M 12 x 1	–	•	–	E 16 MX
CYLF 20 x 050/ERM 16	2620.21622	22	20	50	27.5	M 12 x 1	–	–	–	E 16 M
CYLF 20 x 050/ERMX 16	4620.21622	22	20	50	27.5	M 12 x 1	–	•	–	E 16 MX
CYLF 20 x 070/ERM 16	2620.21642	22	20	70	27.5	M 12 x 1	–	–	–	E 16 M
CYLF 20 x 070/ERMX 16	4620.21642	22	20	70	27.5	M 12 x 1	–	•	–	E 16 MX
CYLF 20 x 120/ERM 16	2620.21682	22	20	120	27.5	M 12 x 1	M 11 x 1	–	–	E 16 M
CYLF 20 x 120/ERMX 16	4620.21682	22	20	120	27.5	M 12 x 1	M 11 x 1	•	–	E 16 MX
CYLF 20 x 140/ERM 16	2620.21692	22	20	140	27.5	M 12 x 1	M 11 x 1	–	–	E 16 M
CYLF 20 x 140/ERMX 16	4620.21692	22	20	140	27.5	M 12 x 1	M 11 x 1	•	–	E 16 MX
CYLF 22 [mm]										
CYLF 22 x 038/ERM 16	2622.21612	22	22	38	27.5	M 12 x 1	–	–	–	E 16 M
CYLF 22 x 038/ERMX 16	4622.21612	22	22	38	27.5	M 12 x 1	–	–	–	E 16 MX
CYLF 22 x 070/ERM 16	2622.21642	22	22	70	27.5	M 12 x 1	–	–	–	E 16 M
CYLF 22 x 070/ERMX 16	4622.21642	22	22	70	27.5	M 12 x 1	–	–	–	E 16 MX
CYLF 22 x 100/ERM 16	2622.21662	22	22	100	27.5	M 12 x 1	M 11 x 1	–	–	E 16 M
CYLF 22 x 100/ERMX 16	4622.21662	22	22	100	27.5	M 12 x 1	M 11 x 1	•	–	E 16 MX
CYLF 22 x 080/ERM 20	2622.22052	28	22	80	39	M 12 x 1	M 12 x 1	–	–	E 20 M
CYLF 22 x 080/ERMX 20	4622.22052	28	22	80	39	M 12 x 1	M 12 x 1	•	–	E 20 MX
CYLF 22 x 070/ERM 25	2622.22542	35	22	70	47	M 12 x 1	M 12 x 1	–	–	E 25 M

Included in delivery: toolholders come with Hi-Q®/ERM or Hi-Q®/ERMX clamping nut and sealing back-up screw

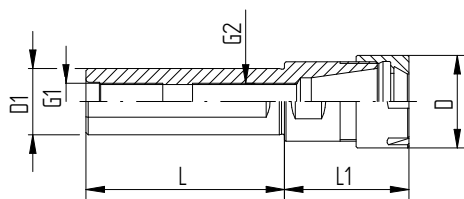

CYLF/ERM

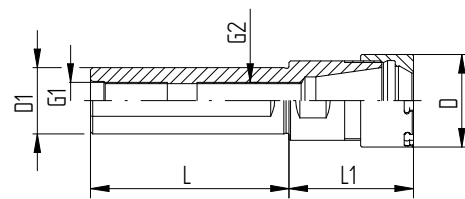

CYLF/ERMX

CYLF/ERM toolholders (mini clamping nut)

CYLF

CYLF/ERMX toolholders with intrRlox® (slip-off proof mini clamping nut)

Type	Part no.	Dimensions [mm]					G1	G2	Slip-off proof	Accessory Wrench
		D	D1 h6	L	L1					
CYLF 25 [mm]										
CYLF 25 x 065/ERM 16	2625.21642	22	25	65	27.5	M 12 x 1	-	-	E 16 M	
CYLF 25 x 065/ERMX 16	4625.21642	22	25	65	27.5	M 12 x 1	-	•	E 16 MX	
CYLF 25 x 100/ERM 20	2625.22062	28	25	100	28	M 14 x 1	M 14 x 1	-	E 20 M	
CYLF 25 x 100/ERMX 20	4625.22062	28	25	100	28	M 14 x 1	M 14 x 1	•	E 20 MX	
CYLF 25 x 154/ERM 20	2625.22002	28	25	154	28	M 14 x 1	M 14 x 1	-	E 20 M	
CYLF 25 x 154/ERMX 20	4625.22002	28	25	154	28	M 14 x 1	M 14 x 1	•	E 20 MX	
CYLF 25 x 075/ERM 25	2625.22552	35	25	75	47	M 14 x 1	M 14 x 1	-	E 25 M	
CYLF 25 x 075/ERMX 25	4625.22552	35	25	75	47	M 14 x 1	M 14 x 1	•	E 25 MX	
CYLF 25 x 145/ERM 25	2625.22592	35	25	145	36	M 14 x 1	M 14 x 1	-	E 25 M	
CYLF 25 x 145/ERMX 25	4625.22592	35	25	145	36	M 14 x 1	M 14 x 1	•	E 25 MX	
CYLF 1 [inch]										
CYLF 1" x 033/ERM 16	2625.21613	22	25.4	33	28	M 12 x 1	-	-	E 16 M	
CYLF 1" x 033/ERMX 16	4625.21613	22	25.4	33	28	M 12 x 1	-	•	E 16 MX	
CYLF 1" x 065/ERM 16	2625.21643	22	25.4	65	27.5	M 12 x 1	-	-	E 16 M	
CYLF 1" x 065/ERMX 16	4625.21643	22	25.4	65	27.5	M 12 x 1	-	•	E 16 MX	
CYLF 1" x 075/ERM 16	2625.21653	22	25.4	75	27.5	M 12 x 1	-	-	E 16 M	
CYLF 1" x 075/ERMX 16	4625.21653	22	25.4	75	27.5	M 12 x 1	-	•	E 16 MX	
CYLF 1" x 100/ERM 16	2625.21663	22	25.4	100	27.5	M 12 x 1	M 11 x 1	-	E 16 M	
CYLF 1" x 100/ERMX 16	4625.21663	22	25.4	100	27.5	M 12 x 1	M 11 x 1	•	E 16 MX	
CYLF 1" x 100/ERM 20	2625.22063	28	25.4	100	27.5	M 14 x 1	M 14 x 1	-	E 20 M	
CYLF 1" x 100/ERMX 20	4625.22063	28	25.4	100	27.5	M 14 x 1	M 14 x 1	•	E 20 MX	
CYLF 1" x 140/ERM 20	2625.22093	28	25.4	140	27.5	M 14 x 1	M 14 x 1	-	E 20 M	
CYLF 1" x 140/ERMX 20	4625.22093	28	25.4	140	27.5	M 14 x 1	M 14 x 1	•	E 20 MX	
CYLF 32 [mm]										
CYLF 32 x 070/ERM 25	2632.22542	35	32	70	30	M 18 x 1.5	-	-	E 25 M	
CYLF 32 x 070/ERMX 25	4632.22542	35	32	70	30	M 18 x 1.5	-	•	E 25 MX	

Included in delivery: toolholders come with Hi-Q®/ERM or Hi-Q®/ERMX clamping nut and back-up screw

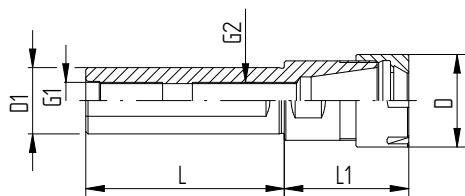

CYLF/ERM

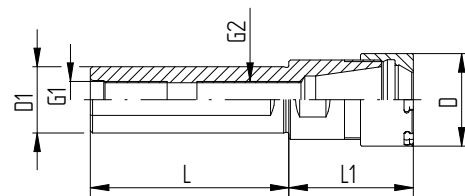

CYLF/ERMX

Type	Part no.	Dimensions [mm]					Accessory	
		D	D1 h6	L	L1	G	Wrench	
CYL 1 1/4 [inch]*								
CYL 1 1/4" x 060/ER NC 25	2632.12533	42	31.75	60	32	M 18 x 1.5	E 25	
CYL 1 1/4" x 060/ER NC 32	2632.13233	50	31.75	60	38	M 22 x 1.5	E 32	
CYL 32 [mm]								
CYL 32 x 060/ER NC 25	2632.12532	42	32	60	32	M 18 x 1.5	E 25	
CYL 32 x 060/ER NC 32	2632.13232	50	32	60	38	M 22 x 1.5	E 32	
CYL 1 1/2 [inch]*								
CYL 1 1/2" x 080/ER NC 32	2638.13253	50	38.1	80	33	M 22 x 1.5	E 32	
CYL 1 1/2" x 075/ER NC 40	2638.14053	63	38.1	75	55	M 22 x 1.5	E 40	
CYL 40 [mm]								
CYL 40 x 080/ER NC 32	2640.13252	50	40	80	39	M 22 x 1.5	E 32	
CYL 40 x 075/ER NC 40	2640.14052	63	40	75	55	M 22 x 1.5	E 40	

Included in delivery: toolholders come with Hi-Q®/ER clamping nut and back-up screw

*USA only

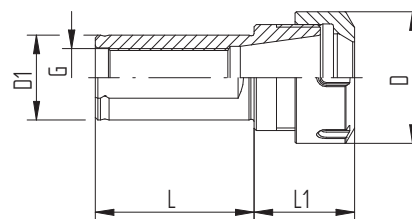

CYDF/ERM toolholders (mini clamping nut)

CYDF

CYDF/ERMX toolholders with intrRlox® (slip-off proof mini clamping nut)

Type	Part no.	Dimensions [mm]					Slip-off proof	Accessory Wrench
		D	D1 h6	L	L1	G		
CYDF 12 [mm]								
CYDF 12 x 015/ERM 8	2612.20804	12	12	15	46	–	–	E 8 M
CYDF 12 x 015/ERMX 8	4612.20804	12	12	15	46	–	•	E 8 MX
CYDF 12 x 025/ERM 8	2612.20814	12	12	25	56	–	–	E 8 M
CYDF 12 x 025/ERMX 8	4612.20814	12	12	25	56	–	•	E 8 MX
CYDF 5/8 [inch]								
CYDF 5/8" x 015/ERM 8	2616.20805	12	15.875	15	46	–	–	E 8 M
CYDF 5/8" x 025/ERM 8	2616.20895	12	15.875	25	56	–	–	E 8 M
CYDF 5/8" x 025/ERMX 8	4616.20895	12	15.875	25	56	–	•	E 8 MX
CYDF 16 [mm]								
CYDF 16 x 040/ERM 11	2616.21114	16	16	40	79	–	–	E 11 M
CYDF 16 x 040/ERMX 11	4616.21114	16	16	40	79	–	•	E 11 MX
CYDF 16 x 050/ERM 11	2616.21124	16	16	50	89	–	–	E 11 M
CYDF 16 x 050/ERMX 11	4616.21124	16	16	50	89	–	•	E 11 MX
CYDF 3/4 [inch]								
CYDF 3/4" x 040/ERM 11	2619.21125	16	19.05	40	79	–	–	E 11 M
CYDF 3/4" x 040/ERMX 11	4619.21125	16	19.05	40	79	–	•	E 11 MX
CYDF 3/4" x 070/ERM 11	2619.21145	16	19.05	70	109	–	–	E 11 M
CYDF 3/4" x 070/ERMX 11	4619.21145	16	19.05	70	109	–	•	E 11 MX
CYDF 3/4" x 090/ERM 11	2619.21165	16	19.05	90	129	–	–	E 11 M
CYDF 3/4" x 090/ERMX 11	4619.21165	16	19.05	90	129	–	•	E 11 MX
CYDF 3/4" x 055/ERM 16	2619.21635	22	19.05	55	107	–	–	E 16 M
CYDF 3/4" x 055/ERMX 16	4619.21635	22	19.05	55	107	–	•	E 16 MX
CYDF 20 [mm]								
CYDF 20 x 030/ERM 11	2620.21114	16	20	30	69	–	–	E 11 M
CYDF 20 x 030/ERMX 11	4620.21114	16	20	30	69	–	•	E 11 MX
CYDF 20 x 050/ERM 11	2620.21124	16	20	50	89	–	–	E 11 M
CYDF 20 x 050/ERMX 11	4620.21124	16	20	50	89	–	•	E 11 MX
CYDF 20 x 055/ERM 16	2620.21634	22	20	55	107	–	–	E 16 M
CYDF 20 x 055/ERMX 16	4620.21634	22	20	55	107	–	•	E 16 MX

Included in delivery: toolholders come with two Hi-Q®/ERM or Hi-Q®/ERMX clamping nuts and back-up screw

CYDF/ERM toolholders (mini clamping nut)

CYDF

CYDF/ERMX toolholders with intrRlox® (slip-off proof mini clamping nut)

Type	Part no.	Dimensions [mm]					Slip-off proof	Accessory Wrench
		D	D1 h6	L	L1	G		
CYDF 22 [mm]								
CYDF 22 x 150/ERM 11	2622.21194	16	22	150	189	–	–	E 11 M
CYDF 22 x 040/ERM 16	2622.21624	22	22	40	80	–	–	E 16 M
CYDF 22 x 055/ERM 16	2622.21634	22	22	55	110	–	–	E 16 M
CYDF 22 x 055/ERMX 16	4622.21634	22	22	55	110	–	•	E 16 MX
CYDF 22 x 075/ERM 16	2622.21654	22	22	75	130	–	–	E 16 M
CYDF 22 x 075/ERMX 16	4622.21654	22	22	75	130	–	•	E 16 MX
CYDF 25 [mm]								
CYDF 25 x 062/ERM 16	2625.21634	22	25	62	117	–	–	E 16 M
CYDF 25 x 062/ERMX 16	4625.21634	22	25	62	117	–	•	E 16 MX
CYDF 1 [inch]								
CYDF 1" x 030/ERM 16	2625.21615	22	25.4	30	86	–	–	E 16 M
CYDF 1" x 030/ERMX 16	4625.21615	22	25.4	30	86	–	•	E 16 MX
CYDF 1" x 062/ERM 16	2625.21635	22	25.4	62	117	–	–	E 16 M
CYDF 1" x 062/ERMX 16	4625.21635	22	25.4	62	117	–	•	E 16 MX
CYDF 32 [mm]								
CYDF 32 x 055/ERM 20	2632.22034	28	32	55	110	–	–	E 20 M
CYDF 32 x 055/ERMX 20	4632.22034	28	32	55	110	–	•	E 20 MX
CYDF 32 x 075/ERM 20	2632.22054	28	32	75	130	–	–	E 20 M
CYDF 32 x 075/ERMX 20	4632.22054	28	32	75	130	–	•	E 20 MX

Included in delivery: toolholders come with two Hi-Q®/ERM or Hi-Q®/ERMX clamping nuts and back-up screw

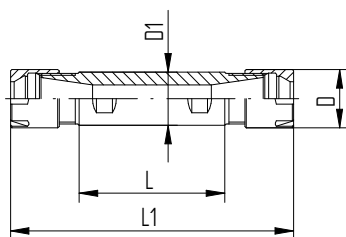

CYDF/ERM

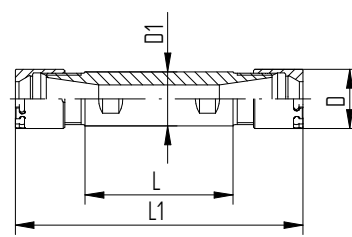

CYDF/ERMX

Morse taper toolholders MK



Applications Morse taper toolholders are designed for drawbar thread application. They can be used on milling or combined drilling-milling machines as well as on boring machines. For drilling machines we supply the corresponding tangs (ATL) on request.

Special applications When extra high clamping force is needed, e.g., when tapping with ER-GB, we recommend the use of our friction-bearing clamping nuts Hi-Q®/ERB and Hi-Q®/ERBC.

Matched tooling system for best fit For highest precision and best results the whole system counts. Therefore REGO-FIX components are carefully matched for optimum fit and accuracy. This guarantees the best runout and balance.

For the influence of runout on tool life see the graph page 270.

Accessories are not included in delivery.

Expert advice

We recommend tightening the clamping nuts with our torque wrench.

For tightening torque recommendations, please refer to page 293.

Type	Dimensions [mm]	
	D	A
MK		
MK 1	12.06	3.5
MK 2	17.78	5.0
MK 3	23.82	5.0
MK 4	31.26	6.5
MK 5	44.39	6.5

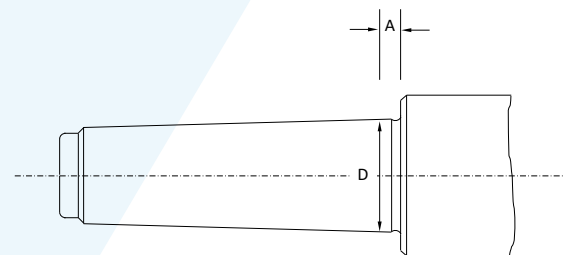

MK 1 – 5

Morse taper toolholders MK

MK

DIN 228-A

Tangs ATL

Type	Part no.	Dimensions [mm]				Accessory
		D	L	G	SW	Wrench
MK 1						
MK 1/ER 16 x 041	2701.11600	28	93.5	M 6	17	E 16 P
MK 2						
MK 2/ER 20 x 049	2702.12000	34	111.5	M 10	22	E 20 P
MK 2/ER 25 x 052	2702.12500	42	115	M 10	27	E 25
MK 2/ER 32 x 060	2702.13200	50	123	M 10	32	E 32
MK 3						
MK 3/ER 25 x 052	2703.12500	42	132	M 12	27	E 25
MK 3/ER 32 x 070	2703.13200	50	150	M 12	32	E 32
MK 4						
MK 4/ER 32 x 060	2704.13200	50	161.5	M 16	32	E 32
MK 4/ER 40 x 082	2704.14000	63	183	M 16	41	E 40
MK 5						
MK 5/ER 40 x 064	2705.14000	63	192	M 20	41	E 40
MK 5/ER 50 x 086	2705.15900	78	214	M 20	50	E 50

Included in delivery: toolholders come with Hi-Q®/ER clamping nut and back-up screw

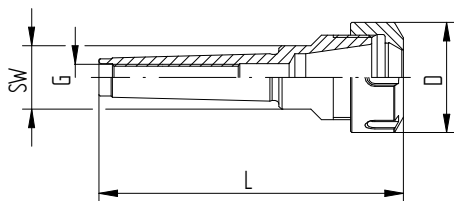

MK/ER

Type	Part no.	G	Dimensions [mm]	
			D	L
Tangs ATL				
ATL 6/MK 1	7221.01000	M 6	8.5	21.5
ATL 10/MK 2	7221.02000	M 10	13.5	30.5
ATL 12/MK 3	7221.03000	M 12	18.5	35
ATL 16/MK 4	7221.04000	M 16	24.5	41
ATL 20/MK 5	7221.05000	M 20	35	52

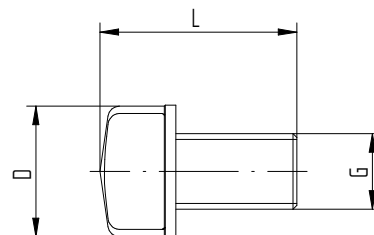

ATL/MK

Automotive shank toolholders SH



Applications Automotive shank toolholders with trapezoidal thread are supplied with a setting nut. With this type of toolholder, ER, ER-GB and PCM ET1 collets can be used.

Special applications A quick-change setting nut according to system BILZ is available as an option. This option must be ordered separately. When extra high clamping force is needed, e.g., when tapping with ER-GB, we recommend the use of our friction-bearing clamping nuts Hi-Q®/ERB and Hi-Q®/ERBC.

Matched tooling system for best fit For highest precision and best results the whole system counts. Therefore REGO-FIX components are carefully matched for optimum fit and accuracy. This guarantees the best runout and balance.

For the influence of runout on tool life see the graph on page 270.

Accessories are not included in delivery.

Expert advice

We recommend tightening the clamping nuts with our torque wrench.

For tightening torque recommendations, please refer to page 293.

Automotive shank toolholders SH

SH

DIN 6327-C

Type	Part no.	Dimensions [mm]			G	G1	SW	Accessory
		D	L1	L2				Wrench
SH 12								
SH 12 x 050/ER 11	2612.11104	19	50	46.6	Tr 12 x 1.5	M 5	12	E 11 P
SH 16								
SH 16 x 073/ER 16	2616.11604	28	73	53.5	Tr 16 x 1.5	M 6	19	E 16 P
SH 20								
SH 20 x 076/ER 20	2620.12004	34	76	59.5	Tr 20 x 2	M 8	22	E 20 P
SH 28								
SH 28 x 083/ER 25	2628.12504	42	83	57	Tr 28 x 2	M 18 x 2	28	E 25

Included in delivery: toolholders come with Hi-Q®/ER clamping nut, back-up screw, setting nut and Woodruff-key

Save time with our quick-change setting nut.

Type	Part no.	Dimensions [mm]			G
		D	D1	L	
Quick-change setting nut (System BILZ)					
SSM 12	7238.12000	22	16.4	18	Tr 12 x 1.5
SSM 16	7238.16000	26	19.9	18.5	Tr 16 x 1.5
SSM 20	7238.20000	33	25.4	20	Tr 20 x 2
SSM 28	7238.28000	42	33.9	22	Tr 28 x 2

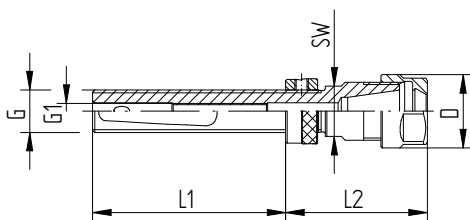

SH/ER

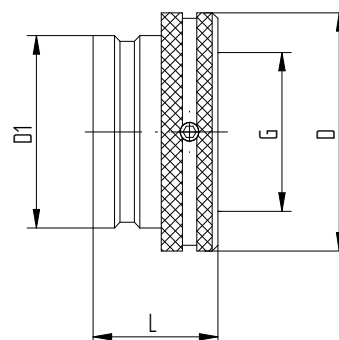

SSM

ISO 20 toolholders



Applications The REGO-FIX ISO 20 toolholders are designed to work with the HAAS Office Mill. To utilize the full potential of your machine, use the REGO-FIX brand of holders and collets to see the difference quality can achieve in your machining operations.

Balancing

// 100% balanced to 50,000 rpm.

Matched tooling system for best fit For highest precision and best results the whole system counts. Therefore REGO-FIX components are carefully matched for optimum fit and accuracy. This guarantees the best runout and balance.

For the influence of runout on tool life see the graph on page 270.

Accessories are not included in delivery.

Expert advice

We recommend tightening the clamping nuts with our torque wrench.

For tightening torque recommendations, please refer to page 293.

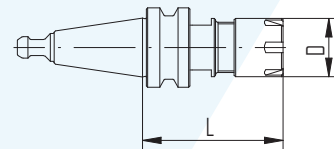

ISO / ERM HAAS

Type	Part no.	Dimensions [mm]		Accessory
		D	L	Wrench
ISO 20				
ISO 20/ERM 11 x 048 HAAS	2420.11116	16	48	E 11 M
ISO 20/ERM 16 x 053 HAAS	2420.11616	22	53	E 16 M
ISO 20/ERM 20 x 055 HAAS	2420.12016	28	55	E 20 M

Included in delivery: ISO toolholder comes with Hi-Q®/ERM mini clamping nut and integral pull stud



ER thread-cutting solutions

CYL SSY/HSK-A SSY Softsynchro® tapping holder

- // With **minimum length compensation**
- // Eliminates small synchronization errors of machines (Rigid Tapping)

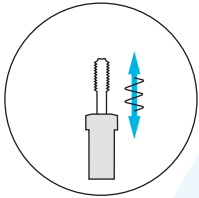

Applications

- // Machines for direct thread cutting
- // For all tapping tools with h9 shanks
- // The turning movement of the spindles can be offset with the feed axis and thus synchronized
- // Synchronization errors are created by the dynamics of the spindle and linear drives. The tapping holder is equipped with the minimum length compensation and compensates the synchronization errors
- // Guides coolant with up to 50 bar of pressure to the tap, without compromising length compensation
- // Depending on the application, the service life for the customer can be increased by up to 150%

Comparative axial force testing

Occurring axial forces with thread forms M10 in St37. Speed 500 rpm
Source: In-house testing

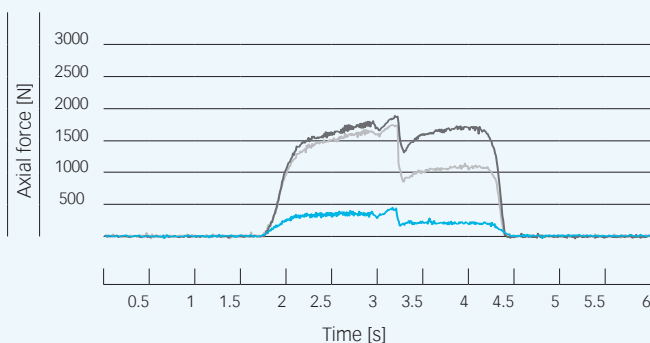

Summary The axial forces increase with increasing speed. With a rigid toolholder, the forces occurring when forming threads are considerably higher than with the Softsynchro® tapping holder. This allows for the optimum use of the synchronous spindle with the best possible service life and thread surface quality.

CYL GSF tapping holder

- // With **length compensation**
- // For machines without a tapping option

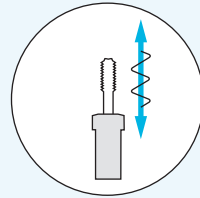

Applications

- // Used on machines in which the feed movement is not synchronized with the thread pitch during processing
- // Ensures the compensation of differences between the thread pitch and spindle feed
- // Features a pressure-point mechanism
- // Safe tap cutting
- // Uniform, reproducible thread depths
- // Guides coolant with up to 50 bar of pressure to the tap, without compromising length compensation
- // Universal use thanks to its compact design and low gauge length

Comparative axial force testing

Occurring axial forces with thread forms M10 in St37. Speed 2.000 rpm
Source: In-house testing

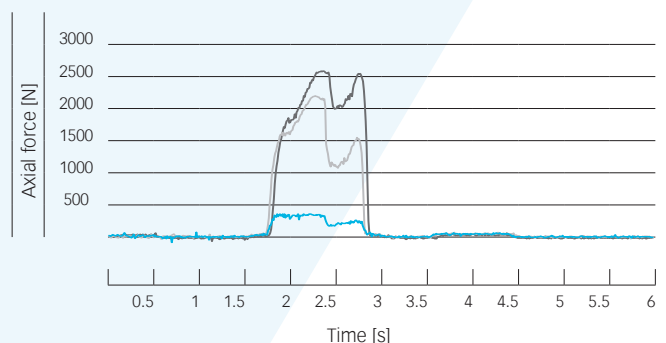

- REGO-FIX Softsynchro® tapping holders
- Competitor synchronous toolholder
- Rigid synchronous toolholder

ER tapping holders

HSK-A SSY

CYL SSY

CYL GSF

69893-A

DIN 1835 B+E

DIN 1835 B+E

ISO 12164

Type	Part no.	Dimensions [mm]		Compression	Tension	SW	Accessory
		D	L	[mm]	[mm]		Wrench
HSK-A 63 SSY							
HSK-A 63 SSY / ERC 20	2563.62000	34	95.5	0.5	0.5	19	E 20 P
HSK-A 63 SSY / ERC 32	2563.63200	50	108.8	0.5	0.5	32	E 32

Included in delivery: Tapping holder comes with Hi-Q® / ERC clamping nut

Type	Part no.	Dimensions [mm]				Compression	Tension	SW	Accessory
		D	D1	L	L1	[mm]	[mm]		Wrench
CYL 25 SSY									
CYL 25 SSY / ERC 20	2625.62000	34	25	73	57	0.5	0.5	19	E 20 P
CYL 25 SSY / ERC 32	2625.63200	50	25	87.5	57	0.5	0.5	32	E 32

Included in delivery: Tapping holder comes with Hi-Q® / ERC clamping nut

Type	Part no.	Dimensions [mm]				Compression	Tension	SW	Accessory
		D	D1	L	L1	[mm]	[mm]		Wrench
CYL 25 GSF									
CYL 25 GSF / ERMC 20	2625.62001	28	25	85	57	5	7.5	28	E 20 M
CYL 25 GSF / ERC 32	2625.63201	50	25	115	57	7	10	34	E 32

Included in delivery: Tapping holder comes with Hi-Q® / ERC or Hi-Q® / ERMC clamping nut

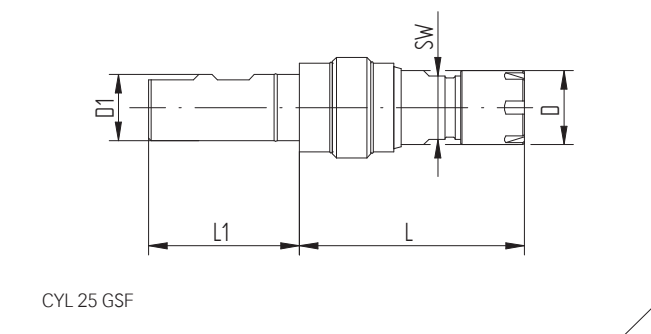
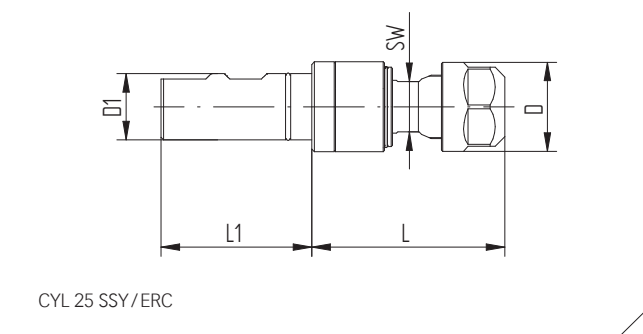
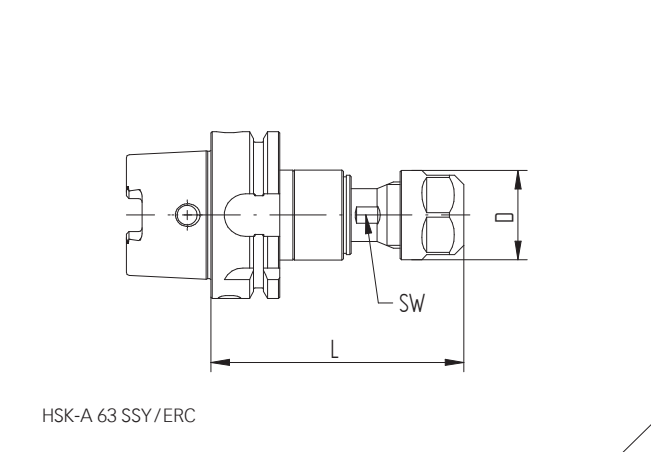

ER floating chucks

When using reamers on lathes it is often necessary to compensate for axis error between the chuck and the bore to be machined. This error can be corrected by using a self-centering floating chuck.

PH/PHC/PHC-C/MPH

Features and benefits

Adjustable floating resistance

Continuously adjustable between auto-centering and free-floating. No restriction of the floating movement.

Adjustment for tool weight

Optimal setup by adjustment of floating resistance is possible.

Vertical and horizontal application

Adjustable self-centering keeps the tool at the center of the floating chuck, even in the horizontal position. Prevents chatter marks and extends tool life.

Combined ball- and friction-bearing

Combined ball and friction-bearing for easy floating:

- // Ball bearing for smooth reaming at low load applications
- // Friction-bearing to withstand high pressures at high load applications

Double sealing against dirt

Prevents coolant and chips from entering the floating chuck.

Excellent bore quality

Only parallel floatation of tool possible.

Floating chuck PH/ER

Features REGO-FIX floating chucks are excellent tools for reaming and tapping:

- // They are specially designed so the tool is self-centering in a vertical and horizontal position
- // The self-centering feature allows very precise positioning of the reaming or tapping tool. This is especially important in horizontal applications, where on ordinary floating chucks the weight of the tool tends to dislocate the tool from the rotational axis
- // The float is always parallel to the rotational axis and the rotation is both clockwise and counter clockwise

Floating chuck PHC/ER for coolant through tools

Features Floating chucks PHC/ER for coolant through tools are especially designed for internal cooling and have the same advantages as the PH/ER floating chucks.

Floating chuck PHC-C/ER REGO-FIX CAPTO

Features These REGO-FIX CAPTO floating chucks are manufactured with polygon interface – licensed by Sandvik Coromant.

Floating chuck MPH/ERMX for tight spaces

Application REGO-FIX MPH/ERMX floating chucks are an efficient solution for tight space applications.

MPHC/ERMXC for tight spaces with internal cooling

Application The MPHC floating chuck is the mini version with internal cooling, common with modern reaming applications.

PH floating chucks for non coolant through tools

PH

Type	Part no.	Dimensions [mm]						Accessory	
		D	D1 h6	D2	L	L1	G	Wrench	
PH 5/8 [inch]									
PH 5/8" / ER 11	2616.91102	22	15.88	38	36	34	0.8	E 11 AX	
PH 16 [mm]									
PH 16/ER 11	2616.91100	22	16	38	36	34	0.8	E 11 AX	
PH 3/4 [inch]									
PH 3/4" / ER 11	2619.91102	22	19.05	38	36	34	0.8	E 11 AX	
PH 20 [mm]									
PH 20/ER 11	2620.91100	22	20	38	36	34	0.8	E 11 AX	
PH 22 [mm]									
PH 22/ER 11	2622.91100	22	22	38	36	34	0.8	E 11 AX	

Included in delivery: Floating holder comes with HI-Q®/ER clamping nut and wrench

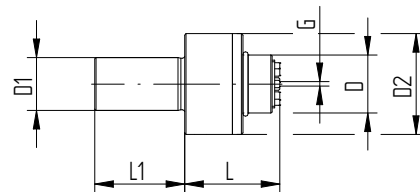

PH/ER

ER

PHC floating chucks for coolant through tools

PHC

Type	Part no.	Dimensions [mm]						Accessory	
		D	D1 h6	D2	L	L1	G	Wrench	
PHC 5/8 [inch]									
PHC 5/8" / ER 20	2616.92004	33	15.88	56	53.5	38	1	E 20 AX	
PHC 16									
PHC 16/ER 20	2616.92003	33	16	56	53.5	38	1	E 20 AX	
PHC 3/4 [inch]									
PHC 3/4" / ER 20	2619.92004	33	19.05	56	53.5	38	1	E 20 AX	
PHC 3/4" / ER 32	2619.93204	46	19.05	70	64.5	46	1.5	E 32 AX	
PHC 20 [mm]									
PHC 20/ER 20	2620.92003	33	20	56	53.5	38	1	E 20 AX	
PHC 20/ER 32	2620.93203	46	20	70	64.5	46	1.5	E 32 AX	
PHC 22 [mm]									
PHC 22/ER 20	2622.92003	33	22	56	53.5	38	1	E 20 AX	
PHC 22/ER 32	2622.93203	46	22	70	64.5	46	1.5	E 32 AX	
PHC 25 [mm]									
PHC 25/ER 20	2625.92003	33	25	56	53.5	38	1	E 20 AX	
PHC 25/ER 32	2625.93203	46	25	70	64.5	46	1.5	E 32 AX	
PHC 1 [inch]									
PHC 1" / ER 20	2625.92004	33	25.4	56	53.5	38	1	E 20 AX	
PHC 1" / ER 32	2625.93204	46	25.4	70	64.5	46	1.5	E 32 AX	
PHC 1 1/4 [inch]									
PHC 1 1/4" / ER 32	2632.93204	46	31.75	70	64.5	46	1.5	E 32 AX	
PHC 32 [mm]									
PHC 32/ER 32	2632.93203	46	32	70	64.5	46	1.5	E 32 AX	
PHC 1 3/4 [inch]									
PHC 1 3/4" / ER 32	2644.93204	46	44.45	70	64.5	46	1.5	E 32 AX	

Included in delivery: Floating holder comes with Hi-Q®/ERAX clamping nut, wrench and adjusting key

Expert advice

When using coolant through tools please order Hi-Q®/ERAXC clamping nuts and the corresponding sealing disks.

PHC floating chucks for coolant through tools with REGO-FIX CAPTO interface

PHC-C

Type	Part no.	Dimensions [mm]					G	Accessory
		D	D2	L	L1	Wrench		
PHC-C3								
PHC-C3/ER 20	2803.92003	33	56	91	53.5	0.8	E 20 AX	
PHC-C4								
PHC-C4/ER 20	2804.92003	33	56	91	56.5	0.8	E 20 AX	
PHC-C4/ER 32	2804.93203	46	70	100	64	0.8	E 32 AX	

Included in delivery: Floating holder comes with Hi-Q®/ERAX clamping nut and wrench

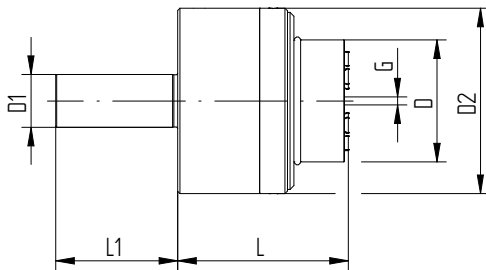

PHC/ER

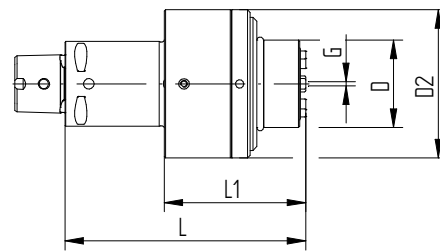

PHC-C/ER

Certified REGO-FIX CAPTO – licensed by Sandvik Coromant – is manufactured at REGO-FIX Switzerland under license according to CAPTO specifications.

MPH mini floating chucks with intrRlox®

MPH

(slip-off proof mini clamping nut)

Type	Part no.	Dimensions [mm]						Accessory	
		D	D1 h6	D2	L	L1	G	Wrench	
MPH 8 [mm]									
MPH 8/ERMX 11	4608.91107	16	8	25	35.5	42	0.5	E 11 MX	
MPH 10 [mm]									
MPH 10/ERMX 11	4610.91107	16	10	25	35.5	42	0.5	E 11 MX	
MPH 16 [mm]									
MPH 16/ERMX 11	4616.91107	16	16	25	35.5	42	0.5	E 11 MX	
MPH 3/4 [inch]									
MPH 3/4" /ERMX 11	4619.91108	16	19.05	25	35.5	70	0.5	E 11 MX	
MPH 20 [mm]									
MPH 20/ERMX 11	4620.91107	16	20	25	35.5	42	0.5	E 11 MX	
MPH 22 [mm]									
MPH 22/ERMX 11	4622.91107	16	22	25	35.5	42	0.5	E 11 MX	
MPH 25 [mm]									
MPH 25/ERMX 11	4625.91107	16	25	25	35.5	42	0.5	E 11 MX	
MPH 1 [inch]									
MPH 1" /ERMX 11	4625.91108	16	25.4	25	35.5	42	0.5	E 11 MX	

Included in delivery: Floating holder comes with Hi-Q®/ERMX clamping nut and wrench

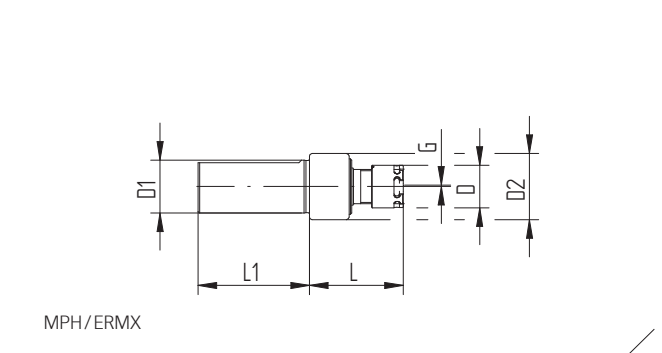

MPHC mini floating chucks with intrRlox®

MPHC

(slip-off proof mini clamping nut)

Type	Part no.	Dimensions [mm]						Accessory	
		D	D1 h6	D2	L	L1	G	Wrench	
MPHC 8 [mm]									
MPHC 8/ERMX 11	4608.91105	16	8	25	35.5	42	0.5	E 11 MX	
MPHC 10 [mm]									
MPHC 10/ERMX 11	4610.91105	16	10	25	35.5	42	0.5	E 11 MX	
MPHC 10/ERMX 16	4610.91605	22	10	31	47	42	0.5	E 16 MX	
MPHC 16 [mm]									
MPHC 16/ERMX 16	4616.91605	22	16	31	47	42	0.5	E 16 MX	
MPHC 3/4 [inch]									
MPHC 3/4"/ERMX 11	4619.91106	16	19.05	25	35.5	42	0.5	E 11 MX	
MPHC 3/4"/ERMX 16	4619.91606	22	19.05	31	47	42	0.5	E 16 MX	
MPHC 20 [mm]									
MPHC 20/ERMX 11	4620.91105	16	20	25	35.5	42	0.5	E 11 MX	
MPHC 20/ERMX 16	4620.91605	22	20	31	47	42	0.5	E 16 MX	
MPHC 22 [mm]									
MPHC 22/ERMX 16	4622.91605	22	22	31	47	42	0.5	E 16 MX	
MPHC 25 [mm]									
MPHC 25/ERMX 16	4625.91605	22	25	31	47	42	0.5	E 16 MX	
MPHC 1 [inch]									
MPH 1"/ERMX 16	4625.91606	22	25.4	31	47	42	0.5	E 16 MX	

Included in delivery: Floating holder comes with Hi-Q®/ERMX clamping nut and wrench

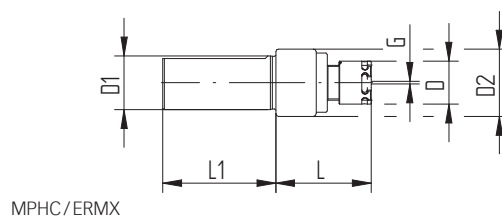

Maintenance instructions for floating chucks

There are two main versions of floating chucks

MPHC



With 2 screws on the side of the flange.

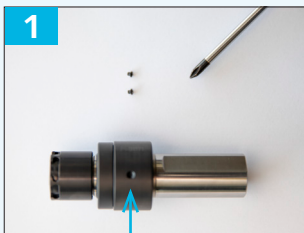

1 Take both screws out with a fitting screwdriver (PH0). Blow out with dry pressurised air.

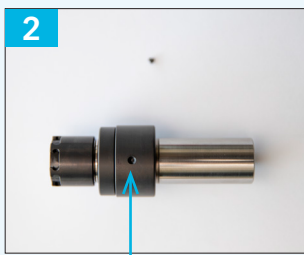

2 Put one screw back. Fill with 10 drops of thin oil.



3 Put the second screw back.

MPH



With one screw in the cylindrical shaft on the back of the floating chuck.

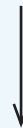

1 Take the screw in the cylinder out with a fitting screwdriver (flat-head1). Blow out with dry pressurised air. Fill with 10 drops of thin oil.

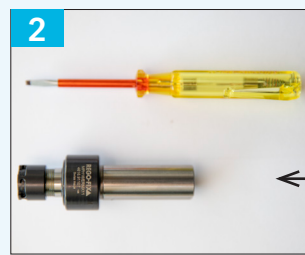

2 Put the screw back in the back (do not forget the spring). Re-adjust the spring tension in the cylinder shaft.



Collet reductions

ER/ERM ERM/ERM ER/ERMX ERMX/ERMX

Features and benefits

Surface finish max. Ra 0.25

Higher clamping force and higher transferable torque.

Applications

The collet reductions are mainly used on Swiss machines with live tooling.

Quick change system

Best suited for quick tool change as the cutting tools can be preinstalled

Length presetting

Tools can be preset outside of the machine.

Minimal external dimensions

Achieve minimal external dimensions by using Hi-Q®/ERM or Hi-Q®/ERMX clamping nuts.

Accessories are not included in delivery



Expert advice

We recommend tightening the clamping nuts with our torque wrench.

For tightening torque recommendations, please refer to page 293.

Collet reductions

ER/ERM

ERM/ERM

Type	Part no.	Dimensions [mm]				Accessory
		D	D1	L	L1	Wrench
ER 11						
ER 11/ERM 8	7162.11080	12	19	33	16.5	E 11 P/E 8 M
ER 16						
ER 16/ERM 11	7162.16110	16	28	42.5	18.5	E 16 P/E 11 M
ER 20						
ER 20/ERM 11*	7162.20110	16	34	42	16.5	E 20 P/E 11 M
ER 20/ERM 16	7162.20160	22	34	55.5	28	E 20 P/E 16 M
ER 25						
ER 25/ERM 11*	7162.25110	16	42	54.4	16.5	E 25/E 11 M
ER 25/ERM 16	7162.25160	22	42	60.5	28	E 25/E 16 M
ER 25/ERM 20	7162.25200	28	42	60.5	28	E 25/E 20 M
ERM 11						
ERM 11/ERM 8	7161.11080	12	16	33	16.5	E 11 M/E 8 M
ERM 16						
ERM 16/ERM 11	7161.16110	16	23	42.5	18.5	E 16 M/E 11 M
ERM 20						
ERM 20/ERM 16	7161.20160	22	28	55.5	28	E 20 M/E 16 M
ERM 25						
ERM 25/ERM 11*	7161.25110	16	35	54.5	22	E 25 M/E 11 M
ERM 25/ERM 16	7161.25160	22	35	60.5	28	E 25 M/E 16 M
ERM 25/ERM 20	7161.25200	28	35	60.5	28	E 25 M/E 20 M
ER 32*						
ER 32/ER 16	7160.32160	28	50	56	29.5	E 32/E 16 P
ER 32/ER 20	7160.32200	34	50	69.5	32.5	E 32/E 20 P

*USA only

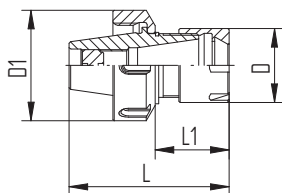

ER/ERM

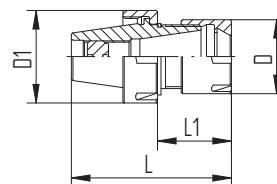

ERM/ERM

Collet reductions with intRlox®

ER/ERMX

ERMX/ERMX

(slip-off proof mini clamping nut)

Type	Part no.	Dimensions [mm]				Accessory
		D	D1	L	L1	Wrench
ER 11						
ER 11/ERMX 8	7165.11080	12	19	33	16.5	E 11 P/E 8 MX
ER 16						
ER 16/ERMX 11	7165.16110	16	28	42.5	18.5	E 16 P/E 11 MX
ER 20						
ER 20/ERMX 11*	7165.20110	16	34	42	16.5	E 20 P/E 11 MX
ER 20/ERMX 16	7165.20160	22	34	55.5	28	E 20 P/E 16 MX
ER 25						
ER 25/ERMX 11*	7165.25110	16	42	54.4	16.5	E 25/E 11 MX
ER 25/ERMX 16	7165.25160	22	42	60.5	28	E 25/E 16 MX
ER 25/ERMX 20	7165.25200	28	42	60.5	28	E 25/E 20 MX
ERMX 11						
ERMX 11/ERMX 8	7164.11080	12	16	33	16.5	E 11 MX/E 8 MX
ERMX 16						
ERMX 16/ERMX 11	7164.16110	16	23	42.5	18.5	E 16 MX/E 11 MX
ERMX 20						
ERMX 20/ERMX 16	7164.20160	22	28	55.5	28	E 20 MX/E 16 MX
ERMX 25						
ERMX 25/ERMX 11*	7164.25110	16	35	54.5	22	E 25 MX/E 11 MX
ERMX 25/ERMX 16	7164.25160	22	35	60.5	28	E 25 MX/E 16 MX

*USA only

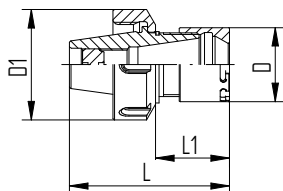

ER/ERMX

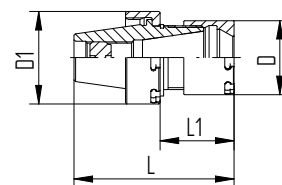

ERMX/ERMX



swissQuick powRgrip® adapter



What is it? The swissQuick ER-to-PG adapter is a short “mini-holder” with a solid ER body profile on the back, with a powRgrip collet cavity on the front. This unique design allows for quick tool changes with an ER fixture while still receiving the benefits of the powRgrip system.

Locking ring The swissQuick is configured with a special locking ring to ensure that the collet body is removed with the nut.

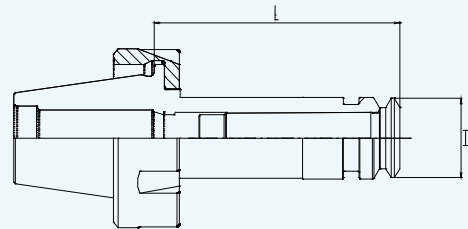







ER-to-PG swissQuick

Type	Part no.	Dimensions [mm]		
		D	L	ER nut thread
ER/PG*				
ER 20/PG 10 swissQuick	7660.20100	16	35.5	M 25 x 1.5
ER 25/PG 15 swissQuick	7660.25150	24	36	M 32 x 1.5
ERM/PG*				
ERM 20/PG 10 swissQuick	7661.20100	16	35.5	M 24 x 1
ERM 25/PG 15 swissQuick	7661.25150	24	36	M 30 x 1

*USA only



Micro-machining	Standard and ultraprecision	micRun®	Metallic sealed	Pullout protection secuRgrip®	Collets for tapping	
ER-MB	ER-Standard/ ER-UP	MR	ER-DM	ER-SG	ER-GB	PCM ET1
						
page 134	page 135	page 199	page 144	page 149	page 150	page 154



Swiss quality ER collets



MB

microbore



Std.

standard



UP

ultra-precision



MR

micRun®



DM

metallic sealed



SG

secuRgrip®



GB

tapping collet



PCM ET1

tapping collet

Main machining use	micro-machining	all	high precision	high precision	internal cooling	heavy machining	rigid tapping	rigid tapping with length compensation
DIN ISO 15488: form ...	A	B	B	B	B	B	A	A
ER size	8–16	8–50	8–50	11–32	11–40	32–40	11–50	11–40
Shaft diameter range	0.2–0.9	1.0–36.0	1.0–36.0	1.0–20.9	3.0–26.0	10.0–25.4	2.5–32.0	1.4–17.0
Clamping range (mm) or tolerance	h7	1	1	h11	0.5	h6	h9	h9
Runout (max)*	6 µm	10 µm	5 µm	2 µm	6 µm	5 µm	10 µm	10 µm
Anti-corrosion coating	–	available on request	available on request	–	available on request	–	available on request	–
Metallic sealed	–	–	–	–	•	–	–	–
Internal square	–	–	–	–	–	–	•	•
Length compensation	–	–	–	–	–	–	–	•
secuRgrip® thread to prevent tool pullout	–	–	–	–	–	•	–	–
Collet-locking system	–	•	•	•	•	•	•	–

*For information about our measuring values, please refer to page 271

Expert advice

Please note that DM collets are not compatible with Weldon or Whistle notch shafts. To achieve internal cooling with Weldon or Whistle notch shafts, use the REGO-FIX sealing disks ER/DS with your REGO-FIX ER collet.

Type	Part no.	Clamping capacity h7	
		[mm]	[decimal inch]
ER 8-MB			
Ø 0.2 mm	1308.00200	0.2	0.0079
Ø 0.3 mm	1308.00300	0.3	0.0118
Ø 0.4 mm	1308.00400	0.4	0.0157
Ø 0.5 mm	1308.00500	0.5	0.0197
Ø 0.6 mm	1308.00600	0.6	0.0236
Ø 0.7 mm	1308.00700	0.7	0.0276
Ø 0.8 mm	1308.00800	0.8	0.0315
Ø 0.9 mm	1308.00900	0.9	0.0354

ER 11-MB			
Ø 0.2 mm	1311.00200	0.2	0.0079
Ø 0.3 mm	1311.00300	0.3	0.0118
Ø 0.4 mm	1311.00400	0.4	0.0157
Ø 0.5 mm	1311.00500	0.5	0.0197
Ø 0.6 mm	1311.00600	0.6	0.0236
Ø 0.7 mm	1311.00700	0.7	0.0276
Ø 0.8 mm	1311.00800	0.8	0.0315
Ø 0.9 mm	1311.00900	0.9	0.0354

ER 16-MB			
Ø 0.2 mm	1316.00200	0.2	0.0079
Ø 0.3 mm	1316.00300	0.3	0.0118
Ø 0.4 mm	1316.00400	0.4	0.0157
Ø 0.5 mm	1316.00500	0.5	0.0197
Ø 0.6 mm	1316.00600	0.6	0.0236
Ø 0.7 mm	1316.00700	0.7	0.0276
Ø 0.8 mm	1316.00800	0.8	0.0315
Ø 0.9 mm	1316.00900	0.9	0.0354

For further technical information, please refer to page 300

Expert advice

Microbore collets have a runout of $\leq 6\mu\text{m}$. They have been developed by REGO-FIX especially for smallest tool shank diameters.

For tool shanks with nominal diameter h7 tolerance only.



ER standard collets and ultraprecision collets ER-UP

ER std.	ER-UP
DIN 6499-B	DIN 6499-B
ISO 15488	ISO 15488

Type	Part no.		Clamping range		Ø [inch]	Included in set
	ER standard	ER-UP	[mm]	[decimal inch]		
ER 8 [mm]						
SET ER 8	1108.00000	1108.00001	0.5–5.0	0.0197–0.1969	–	–
Ø 1.0 mm	1108.01000	1108.01001	1.0–0.5	0.0394–0.0197	1/32"	•
Ø 1.5 mm	1108.01500	1108.01501	1.5–1.0	0.0591–0.0394	–	•
Ø 2.0 mm	1108.02000	1108.02001	2.0–1.5	0.0787–0.0591	1/16"*	•
Ø 2.5 mm	1108.02500	1108.02501	2.5–2.0	0.0984–0.0787	3/32"	•
Ø 3.0 mm	1108.03000	1108.03001	3.0–2.5	0.1181–0.0984	–	•
Ø 3.5 mm	1108.03500	1108.03501	3.5–3.0	0.1378–0.1181	1/8"*	•
Ø 4.0 mm	1108.04000	1108.04001	4.0–3.5	0.1575–0.1378	5/32"	•
Ø 4.5 mm	1108.04500	1108.04501	4.5–4.0	0.1772–0.1575	–	•
Ø 5.0 mm	1108.05000	1108.05001	5.0–4.5	0.1969–0.1772	3/16"*	•
ER 8 [inch]						
INCH SET ER 8	1108.00002	1108.00003	1.09–4.76	0.0429–0.1875	–	–
Ø 1/16"	1108.01592	1108.01593	1.59–1.09	0.0625–0.0429	–	•
Ø 1/8"	1108.03182	1108.03183	3.18–2.68	0.125–0.1055	–	•
Ø 3/16"	1108.04762	1108.04763	4.76–4.25	0.1875–0.1675	–	•
ER 11 [mm]						
SET ER 11	1111.00000	1111.00001	0.5–7.0	0.0197–0.2756	–	–
Ø 1.0 mm	1111.01000	1111.01001	1.0–0.5	0.0394–0.0197	1/32"	•
Ø 1.5 mm	1111.01500	1111.01501	1.5–1.0	0.0591–0.0394	–	•
Ø 2.0 mm	1111.02000	1111.02001	2.0–1.5	0.0787–0.0591	1/16"*	•
Ø 2.5 mm	1111.02500	1111.02501	2.5–2.0	0.0984–0.0787	3/32"*	•
Ø 3.0 mm	1111.03000	1111.03001	3.0–2.5	0.1181–0.0984	–	•
Ø 3.5 mm	1111.03500	1111.03501	3.5–3.0	0.1378–0.1181	1/8"*	•
Ø 4.0 mm	1111.04000	1111.04001	4.0–3.5	0.1575–0.1378	5/32"*	•
Ø 4.5 mm	1111.04500	1111.04501	4.5–4.0	0.1772–0.1575	–	•
Ø 5.0 mm	1111.05000	1111.05001	5.0–4.5	0.1969–0.1772	3/16"*	•
Ø 5.5 mm	1111.05500	1111.05501	5.5–5.0	0.2165–0.1969	–	•
Ø 6.0 mm	1111.06000	1111.06001	6.0–5.5	0.2362–0.2165	7/32"*	•
Ø 6.5 mm	1111.06500	1111.06501	6.5–6.0	0.2559–0.2362	1/4"*	•
Ø 7.0 mm	1111.07000	1111.07001	7.0–6.5	0.2756–0.2559	–	•

Included in the ER sets are all marked collets within that size and the matching collet tray ZWT

*Approx. inch sizing

For further technical information, please refer to page 295

Expert advice

Various ER collets are available on request with an anti-corrosion coating for improved collet lifetime.

ER standard collets and ultraprecision collets ER-UP

ER std.	ER-UP
DIN 6499-B	DIN 6499-B
ISO 15488	ISO 15488

Type	Part no.		Clamping range		Ø [inch]	Included in set
	ER standard	ER-UP	[mm]	[decimal inch]		
ER 11 [inch]						
INCH SET ER 11	1111.00002	1111.00003	1.09–6.35	0.0429–0.25	–	–
Ø 1/16"	1111.01592	1111.01593	1.59–1.09	0.0625–0.0429	1/16"	•
Ø 3/32"	1111.02382	1111.02383	2.38–1.87	0.0938–0.0738	3/32"	•
Ø 1/8"	1111.03182	1111.03183	3.18–2.67	0.125–0.105	1/8"	•
Ø 5/32"	1111.03972	1111.03973	3.97–3.46	0.1563–0.1363	5/32"	•
Ø 3/16"	1111.04762	1111.04763	4.76–4.25	0.1875–0.1675	3/16"	•
Ø 7/32"	1111.05562	1111.05563	5.56–5.04	0.2188–0.1988	7/32"	•
Ø 1/4"	1111.06352	1111.06353	6.35–5.84	0.25–0.23	1/4"	•

ER 16 [mm]						
SET ER 16	1116.00000	1116.00001	0.5–10.0	0.0197–0.3937	–	–
Ø 1.0 mm	1116.01000	1116.01001	1.0–0.5	0.0394–0.0197	1/32"	•
Ø 1.5 mm	1116.01500	1116.01501	1.5–1.0	0.0591–0.0394	–	–
Ø 2.0 mm	1116.02000	1116.02001	2.0–1.0	0.0787–0.0394	1/16"*	•
Ø 2.5 mm	1116.02500	1116.02501	2.5–1.5	0.0984–0.0591	3/32"*	–
Ø 3.0 mm	1116.03000	1116.03001	3.0–2.0	0.1181–0.0787	–	•
Ø 3.5 mm	1116.03500	1116.03501	3.5–2.5	0.1378–0.0984	1/8"*	–
Ø 4.0 mm	1116.04000	1116.04001	4.0–3.0	0.1575–0.1181	5/32"*	•
Ø 4.5 mm	1116.04500	1116.04501	4.5–3.5	0.1772–0.1378	–	–
Ø 5.0 mm	1116.05000	1116.05001	5.0–4.0	0.1969–0.1575	3/16"*	•
Ø 5.5 mm	1116.05500	1116.05501	5.5–4.5	0.2165–0.1772	–	–
Ø 6.0 mm	1116.06000	1116.06001	6.0–5.0	0.2362–0.1969	7/32"*	•
Ø 6.5 mm	1116.06500	1116.06501	6.5–5.5	0.2559–0.2165	1/4"*	–
Ø 7.0 mm	1116.07000	1116.07001	7.0–6.0	0.2756–0.2362	–	•
Ø 7.5 mm	1116.07500	1116.07501	7.5–6.5	0.2953–0.2559	9/32"*	–
Ø 8.0 mm	1116.08000	1116.08001	8.0–7.0	0.315–0.2756	5/16"*	•
Ø 8.5 mm	1116.08500	1116.08501	8.5–7.5	0.3346–0.2953	–	–
Ø 9.0 mm	1116.09000	1116.09001	9.0–8.0	0.3543–0.315	11/32"*	•
Ø 9.5 mm	1116.09500	1116.09501	9.5–8.5	0.374–0.3346	–	–
Ø 10.0 mm	1116.10000	1116.10001	10.0–9.0	0.3937–0.3543	3/8"*	•

ER 16 [inch]						
INCH SET ER 16	1116.00002	1116.00003	1.09–10.32	0.0429–0.4063	–	–
Ø 1/16"	1116.01592	1116.01593	1.59–1.09	0.0625–0.0429	1/16"	•
Ø 3/32"	1116.02382	1116.02383	2.38–1.87	0.0938–0.0738	3/32"	•
Ø 1/8"	1116.03182	1116.03183	3.18–2.16	0.125–0.085	1/8"	•
Ø 5/32"	1116.03972	1116.03973	3.97–2.95	0.1563–0.1163	5/32"	•
Ø 3/16"	1116.04762	1116.04763	4.76–3.75	0.1875–0.1475	3/16"	•

Included in the ER sets are all marked collets within that size and the matching collet tray ZWT

*Approx. inch sizing

ER standard collets and ultraprecision collets ER-UP

ER std.	ER-UP
DIN 6499-B	DIN 6499-B
ISO 15488	ISO 15488

Type	Part no.		Clamping range		Ø [inch]	Included in set
	ER standard	ER-UP	[mm]	[decimal inch]		
Ø 7/32"	1116.05562	1116.05563	5.56–4.54	0.2188–0.1788	7/32"	•
Ø 1/4"	1116.06352	1116.06353	6.35–5.33	0.25–0.21	1/4"	•
Ø 9/32"	1116.07142	1116.07143	7.15–6.13	0.2813–0.2413	9/32"	•
Ø 5/16"	1116.07942	1116.07943	7.94–6.92	0.3125–0.2725	5/16"	•
Ø 11/32"	1116.08732	1116.08733	8.73–7.72	0.3438–0.3038	11/32"	•
Ø 3/8"	1116.09532	1116.09533	9.53–8.51	0.375–0.335	3/8"	•
Ø 13/32"	1116.10322	1116.10323	10.32–9.3	0.4063–0.3663	13/32"	•

ER 20 [mm]						
SET ER 20	1120.00000	1120.00001	1.0–13.0	0.0394–0.5118	–	–
Ø 1.0 mm	1120.01000	1120.01001	1.0–0.5	0.0394–0.0197	1/32"	–
Ø 1.5 mm	1120.01500	1120.01501	1.5–1.0	0.0591–0.0394	–	–
Ø 2.0 mm	1120.02000	1120.02001	2.0–1.0	0.0787–0.0394	1/16"	•
Ø 2.5 mm	1120.02500	1120.02501	2.5–1.5	0.0984–0.0591	3/32"	–
Ø 3.0 mm	1120.03000	1120.03001	3.0–2.0	0.1181–0.0787	–	•
Ø 3.5 mm	1120.03500	1120.03501	3.5–2.5	0.1378–0.0984	1/8"	–
Ø 4.0 mm	1120.04000	1120.04001	4.0–3.0	0.1575–0.1181	5/32"	•
Ø 4.5 mm	1120.04500	1120.04501	4.5–3.5	0.1772–0.1378	–	–
Ø 5.0 mm	1120.05000	1120.05001	5.0–4.0	0.1969–0.1575	3/16"	•
Ø 5.5 mm	1120.05500	1120.05501	5.5–4.5	0.2165–0.1772	–	–
Ø 6.0 mm	1120.06000	1120.06001	6.0–5.0	0.2362–0.1969	7/32"	•
Ø 6.5 mm	1120.06500	1120.06501	6.5–5.5	0.2559–0.2165	1/4"	–
Ø 7.0 mm	1120.07000	1120.07001	7.0–6.0	0.2756–0.2362	–	•
Ø 7.5 mm	1120.07500	1120.07501	7.5–6.5	0.2953–0.2559	9/32"	–
Ø 8.0 mm	1120.08000	1120.08001	8.0–7.0	0.315–0.2756	5/16"	•
Ø 8.5 mm	1120.08500	1120.08501	8.5–7.5	0.3346–0.2953	–	–
Ø 9.0 mm	1120.09000	1120.09001	9.0–8.0	0.3543–0.315	11/32"	•
Ø 9.5 mm	1120.09500	1120.09501	9.5–8.5	0.374–0.3346	–	–
Ø 10.0 mm	1120.10000	1120.10001	10.0–9.0	0.3937–0.3543	3/8"	•
Ø 10.5 mm	1120.10500	1120.10501	10.5–9.5	0.4134–0.374	13/32"	–
Ø 11.0 mm	1120.11000	1120.11001	11.0–10.0	0.4331–0.3937	–	•
Ø 11.5 mm	1120.11500	1120.11501	11.5–10.5	0.4528–0.4134	7/16"	–
Ø 12.0 mm	1120.12000	1120.12001	12.0–11.0	0.4724–0.433	15/32"	•
Ø 12.5 mm	1120.12500	1120.12501	12.5–11.5	0.4921–0.4528	–	–
Ø 13.0 mm	1120.13000	1120.13001	13.0–12.0	0.5118–0.4724	1/2"	•

Included in the ER sets are all marked collets within that size and the matching collet tray ZWT

*Approx. inch sizing

For further technical information, please refer to page 295

ER standard collets and ultraprecision collets ER-UP

ER std.	ER-UP
DIN 6499-B	DIN 6499-B
ISO 15488	ISO 15488

Type	Part no.		Clamping range		Ø [inch]	Included in set
	ER standard	ER-UP	[mm]	[decimal inch]		
ER 20 [inch]						
INCH SET ER 20	1120.00002	1120.00003	2.16–12.7	0.085–0.5	–	–
Ø 1/8"	1120.03182	1120.03183	3.18–2.18	0.125–0.085	1/8"	•
Ø 3/16"	1120.04762	1120.04763	4.76–3.76	0.1875–0.1475	3/16"	•
Ø 1/4"	1120.06352	1120.06353	6.35–5.35	0.25–0.21	1/4"	•
Ø 5/16"	1120.07942	1120.07943	7.94–6.94	0.3125–0.2725	5/16"	•
Ø 3/8"	1120.09532	1120.09533	9.53–8.53	0.375–0.335	3/8"	•
Ø 7/16"	1120.11112	1120.11113	11.11–10.11	0.4375–0.3975	7/16"	•
Ø 1/2"	1120.12702	1120.12703	12.7–11.7	0.5–0.46	1/2"	•
ER 25 [mm]						
SET ER 25	1125.00000	1125.00001	2.0–16.0	0.0787–0.6299	–	–
Ø 1.0 mm	1125.01000	1125.01001	1.0–0.5	0.0394–0.0197	1/32"	–
Ø 1.5 mm	1125.01500	1125.01501	1.5–1.0	0.0591–0.0394	–	–
Ø 2.0 mm	1125.02000	1125.02001	2.0–1.0	0.0787–0.0394	1/16"	•
Ø 2.5 mm	1125.02500	1125.02501	2.5–1.5	0.0984–0.0591	3/32"	–
Ø 3.0 mm	1125.03000	1125.03001	3.0–2.0	0.1181–0.0787	–	•
Ø 3.5 mm	1125.03500	1125.03501	3.5–2.5	0.1378–0.0984	1/8"*	–
Ø 4.0 mm	1125.04000	1125.04001	4.0–3.0	0.1575–0.1181	5/32"	•
Ø 4.5 mm	1125.04500	1125.04501	4.5–3.5	0.1772–0.1378	–	–
Ø 5.0 mm	1125.05000	1125.05001	5.0–4.0	0.1969–0.1575	3/16"*	•
Ø 5.5 mm	1125.05500	1125.05501	5.5–4.5	0.2165–0.1772	–	–
Ø 6.0 mm	1125.06000	1125.06001	6.0–5.0	0.2362–0.1969	7/32"	•
Ø 6.5 mm	1125.06500	1125.06501	6.5–5.5	0.2559–0.2165	1/4"*	–
Ø 7.0 mm	1125.07000	1125.07001	7.0–6.0	0.2756–0.2362	–	•
Ø 7.5 mm	1125.07500	1125.07501	7.5–6.5	0.2953–0.2559	9/32"	–
Ø 8.0 mm	1125.08000	1125.08001	8.0–7.0	0.315–0.2756	5/16"*	•
Ø 8.5 mm	1125.08500	1125.08501	8.5–7.5	0.3346–0.2953	–	–
Ø 9.0 mm	1125.09000	1125.09001	9.0–8.0	0.3543–0.315	11/32"	•
Ø 9.5 mm	1125.09500	1125.09501	9.5–8.5	0.374–0.3346	–	–
Ø 10.0 mm	1125.10000	1125.10001	10.0–9.0	0.3937–0.3543	3/8"*	•
Ø 10.5 mm	1125.10500	1125.10501	10.5–9.5	0.4134–0.374	13/32"	–
Ø 11.0 mm	1125.11000	1125.11001	11.0–10.0	0.4331–0.3937	–	•
Ø 11.5 mm	1125.11500	1125.11501	11.5–10.5	0.4528–0.4134	7/16"*	–
Ø 12.0 mm	1125.12000	1125.12001	12.0–11.0	0.4724–0.4331	15/32"	•
Ø 12.5 mm	1125.12500	1125.12501	12.5–11.5	0.4921–0.4528	–	–
Ø 13.0 mm	1125.13000	1125.13001	13.0–12.0	0.5118–0.4724	1/2"*	•
Ø 13.5 mm	1125.13500	1125.13501	13.5–12.5	0.5315–0.4921	17/32"	–
Ø 14.0 mm	1125.14000	1125.14001	14.0–13.0	0.5512–0.5118	–	•

Included in the ER sets are all marked collets within that size and the matching collet tray ZWT

*Approx. inch sizing

ER standard collets and ultraprecision collets ER-UP

ER std.	ER-UP
DIN 6499-B	DIN 6499-B
ISO 15488	ISO 15488

Type	Part no.		Clamping range		Ø [inch]	Included in set
	ER standard	ER-UP	[mm]	[decimal inch]		
Ø 14.5 mm	1125.14500	1125.14501	14.5–13.5	0.5709–0.5315	9/16"*	–
Ø 15.0 mm	1125.15000	1125.15001	15.0–14.0	0.5906–0.5512	–	•
Ø 15.5 mm	1125.15500	1125.15501	15.5–14.5	0.6102–0.5709	19/32"	–
Ø 16.0 mm	1125.16000	1125.16001	16.0–15.0	0.6299–0.5905	5/8"*	•
Ø 17.0 mm	1125.17000	1125.17001	17.0–16.0	0.6693–0.6299	21/32"	–

ER 25 [inch]						
INCH SET ER 25	1125.00002	1125.00003	2.16–15.88	0.085–0.625	–	–
Ø 1/8"	1125.03182	1125.03183	3.18–2.16	0.125–0.085	1/8"	•
Ø 3/16"	1125.04762	1125.04763	4.76–3.75	0.1875–0.1475	3/16"	•
Ø 1/4"	1125.06352	1125.06353	6.35–5.33	0.25–0.21	1/4"	•
Ø 5/16"	1125.07942	1125.07943	7.94–6.92	0.3125–0.2725	5/16"	•
Ø 3/8"	1125.09532	1125.09533	9.53–8.51	0.375–0.335	3/8"	•
Ø 7/16"	1125.11112	1125.11113	11.11–10.11	0.4375–0.3975	7/16"	•
Ø 1/2"	1125.12702	1125.12703	12.70–11.68	0.5–0.46	1/2"	•
Ø 9/16"	1125.14292	1125.14293	14.29–13.27	0.5625–0.5225	9/16"	•
Ø 5/8"	1125.15882	1125.15883	15.88–14.78	0.625–0.582	5/8"	•

ER 32 [mm]						
SET ER 32	1132.00000	1132.00001	2.0–20.0	0.0787–0.7874	–	–
Ø 2.0 mm	1132.02000	1132.02001	2.0–1.0	0.0787–0.0394	1/16"	–
Ø 2.5 mm	1132.02500	1132.02501	2.5–1.5	0.0984–0.0591	3/32"	–
Ø 3.0 mm	1132.03000	1132.03001	3.0–2.0	0.1181–0.0787	–	•
Ø 3.5 mm	1132.03500	1132.03501	3.5–2.5	0.1378–0.0984	1/8"*	–
Ø 4.0 mm	1132.04000	1132.04001	4.0–3.0	0.1575–0.1181	5/32"	•
Ø 4.5 mm	1132.04500	1132.04501	4.5–3.5	0.1772–0.1378	–	–
Ø 5.0 mm	1132.05000	1132.05001	5.0–4.0	0.1969–0.1575	3/16"*	•
Ø 5.5 mm	1132.05500	1132.05501	5.5–4.5	0.2165–0.1772	–	–
Ø 6.0 mm	1132.06000	1132.06001	6.0–5.0	0.2362–0.1969	7/32"	•
Ø 6.5 mm	1132.06500	1132.06501	6.5–5.5	0.2559–0.2165	1/4"*	–
Ø 7.0 mm	1132.07000	1132.07001	7.0–6.0	0.2756–0.2362	–	•
Ø 7.5 mm	1132.07500	1132.07501	7.5–6.5	0.2953–0.2559	9/32"	–
Ø 8.0 mm	1132.08000	1132.08001	8.0–7.0	0.315–0.2756	5/16"*	•
Ø 8.5 mm	1132.08500	1132.08501	8.5–7.5	0.3346–0.2953	–	–
Ø 9.0 mm	1132.09000	1132.09001	9.0–8.0	0.3543–0.315	11/32"	•
Ø 9.5 mm	1132.09500	1132.09501	9.5–8.5	0.374–0.3346	–	–
Ø 10.0 mm	1132.10000	1132.10001	10.0–9.0	0.3937–0.3543	3/8"*	•
Ø 10.5 mm	1132.10500	1132.10501	10.5–9.5	0.4134–0.374	13/32"	–
Ø 11.0 mm	1132.11000	1132.11001	11.0–10.0	0.4331–0.3937	–	•

Included in the ER sets are all marked collets within that size and the matching collet tray ZWT

*Approx. inch sizing

For further technical information, please refer to page 295

ER standard collets and ultraprecision collets ER-UP

ER std.	ER-UP
DIN 6499-B	DIN 6499-B
ISO 15488	ISO 15488

Type	Part no.		Clamping range		Ø [inch]	Included in set
	ER standard	ER-UP	[mm]	[decimal inch]		
ER 32 [mm] continued						
Ø 11.5 mm	1132.11500	1132.11501	11.5–10.5	0.4528–0.4134	7/16"*	–
Ø 12.0 mm	1132.12000	1132.12001	12.0–11.0	0.4724–0.4331	15/32"	•
Ø 12.5 mm	1132.12500	1132.12501	12.5–11.5	0.4921–0.4528	–	–
Ø 13.0 mm	1132.13000	1132.13001	13.0–12.0	0.5118–0.4724	1/2"*	•
Ø 13.5 mm	1132.13500	1132.13501	13.5–12.5	0.5315–0.4921	17/32"	–
Ø 14.0 mm	1132.14000	1132.14001	14.0–13.0	0.5512–0.5118	–	•
Ø 14.5 mm	1132.14500	1132.14501	14.5–13.5	0.5709–0.5315	9/16"*	–
Ø 15.0 mm	1132.15000	1132.15001	15.0–14.0	0.5906–0.5512	–	•
Ø 15.5 mm	1132.15500	1132.15501	15.5–14.5	0.6102–0.5709	19/32"	–
Ø 16.0 mm	1132.16000	1132.16001	16.0–15.0	0.63299–0.5906	5/8"*	•
Ø 16.5 mm	1132.16500	1132.16501	16.5–15.5	0.6496–0.6102	–	–
Ø 17.0 mm	1132.17000	1132.17001	17.0–16.0	0.6693–0.6299	21/32"	•
Ø 17.5 mm	1132.17500	1132.17501	17.5–16.5	0.689–0.6496	11/16"*	–
Ø 18.0 mm	1132.18000	1132.18001	18.0–17.0	0.7087–0.6693	–	•
Ø 18.5 mm	1132.18500	1132.18501	18.5–17.5	0.7283–0.689	23/32"	–
Ø 19.0 mm	1132.19000	1132.19001	19.0–18.0	0.748–0.7078	–	•
Ø 19.5 mm	1132.19500	1132.19501	19.5–18.5	0.7677–0.7284	3/4"*	–
Ø 20.0 mm	1132.20000	1132.20001	20.0–19.0	0.7874–0.748	25/32"	•
Ø 21.0 mm	1132.21000	1132.21001	21.0–20.0	0.8268–0.7874	13/16"*	–
Ø 22.0 mm	1132.22000	1132.22001	22.0–21.0	0.8661–0.8268	–	–

ER 32 [inch]						
INCH SET ER 32	1132.00002	1132.00003	2.16–20.64	0.085–0.8125	–	–
Ø 1/8"	1132.03182	1132.03183	3.18–2.16	0.125–0.085	1/8"	•
Ø 3/16"	1132.04762	1132.04763	4.76–3.75	0.1875–0.1475	3/16"	•
Ø 1/4"	1132.06352	1132.06353	6.35–5.33	0.25–0.21	1/4"	•
Ø 5/16"	1132.07942	1132.07943	7.94–6.92	0.3125–0.2725	5/16"	•
Ø 3/8"	1132.09532	1132.09533	9.53–8.51	0.375–0.335	3/8"	•
Ø 7/16"	1132.11112	1132.11113	11.11–10.1	0.4375–0.3975	7/16"	•
Ø 1/2"	1132.12702	1132.12703	12.7–11.68	0.5–0.46	1/2"	•
Ø 9/16"	1132.14292	1132.14293	14.29–13.27	0.5625–0.5225	9/16"	•
Ø 5/8"	1132.15882	1132.15883	15.88–14.86	0.625–0.585	5/8"	•
Ø 11/16"	1132.17462	1132.17463	17.46–16.45	0.6875–0.6475	11/16"	•
Ø 3/4"	1132.19052	1132.19053	19.05–18.03	0.75–0.71	3/4"	•
Ø 13/16"	1132.20642	1132.20643	20.64–19.62	0.8125–0.7725	13/16"	•

Included in the ER sets are all marked collets within that size and the matching collet tray ZWT

*Approx. inch sizing

ER standard collets and ultraprecision collets ER-UP

ER std.	ER-UP
DIN 6499-B	DIN 6499-B
ISO 15488	ISO 15488

Type	Part no.		Clamping range		Ø [inch]	Included in set
	ER standard	ER-UP	[mm]	[decimal inch]		
ER 40 [mm]						
SET ER 40	1140.00000	1140.00001	3.0–26.0	0.1181–1.0236	–	–
Ø 3.0 mm	1140.03000	1140.03001	3.0–2.0	0.1181–0.0787	3/32"	–
Ø 3.5 mm	1140.03500	1140.03501	3.5–2.5	0.1378–0.0984	1/8"*	–
Ø 4.0 mm	1140.04000	1140.04001	4.0–3.0	0.1575–0.1181	5/32"	•
Ø 4.5 mm	1140.04500	1140.04501	4.5–3.5	0.1772–0.1378	–	–
Ø 5.0 mm	1140.05000	1140.05001	5.0–4.0	0.1969–0.1575	3/16"*	•
Ø 5.5 mm	1140.05500	1140.05501	5.5–4.5	0.2165–0.1772	–	–
Ø 6.0 mm	1140.06000	1140.06001	6.0–5.0	0.2362–0.1969	7/32"	•
Ø 6.5 mm	1140.06500	1140.06501	6.5–5.5	0.2559–0.2165	1/4"*	–
Ø 7.0 mm	1140.07000	1140.07001	7.0–6.0	0.2756–0.2362	–	•
Ø 7.5 mm	1140.07500	1140.07501	7.5–6.5	0.2953–0.2559	9/32"	–
Ø 8.0 mm	1140.08000	1140.08001	8.0–7.0	0.315–0.2756	5/16"*	•
Ø 8.5 mm	1140.08500	1140.08501	8.5–7.5	0.3346–0.2953	–	–
Ø 9.0 mm	1140.09000	1140.09001	9.0–8.0	0.3543–0.315	–	•
Ø 9.5 mm	1140.09500	1140.09501	9.5–8.5	0.374–0.3346	11/32"	–
Ø 10.0 mm	1140.10000	1140.10001	10.0–9.0	0.3937–0.3543	3/8"*	•
Ø 10.5 mm	1140.10500	1140.10501	10.5–9.5	0.4134–0.374	13/32"	–
Ø 11.0 mm	1140.11000	1140.11001	11.0–10.0	0.4331–0.3937	–	•
Ø 11.5 mm	1140.11500	1140.11501	11.5–10.5	0.4528–0.4134	7/16"*	–
Ø 12.0 mm	1140.12000	1140.12001	12.0–11.0	0.4724–0.4331	15/32"	•
Ø 12.5 mm	1140.12500	1140.12501	12.5–11.5	0.4921–0.4528	–	–
Ø 13.0 mm	1140.13000	1140.13001	13.0–12.0	0.5118–0.4724	1/2"*	•
Ø 13.5 mm	1140.13500	1140.13501	13.5–12.5	0.5315–0.4921	17/32"	–
Ø 14.0 mm	1140.14000	1140.14001	14.0–13.0	0.5512–0.5118	–	•
Ø 14.5 mm	1140.14500	1140.14501	14.5–13.5	0.5709–0.5315	9/16"*	–
Ø 15.0 mm	1140.15000	1140.15001	15.0–14.0	0.5906–0.5512	–	•
Ø 15.5 mm	1140.15500	1140.15501	15.5–14.5	0.6102–0.5709	19/32"	–
Ø 16.0 mm	1140.16000	1140.16001	16.0–15.0	0.6299–0.5906	5/8"*	•
Ø 16.5 mm	1140.16500	1140.16501	16.5–15.5	0.6496–0.6102	–	–
Ø 17.0 mm	1140.17000	1140.17001	17.0–16.0	0.6693–0.6299	21/32"	•
Ø 17.5 mm	1140.17500	1140.17501	17.5–16.5	0.689–0.6496	11/16"*	–
Ø 18.0 mm	1140.18000	1140.18001	18.0–17.0	0.7078–0.6693	–	•
Ø 18.5 mm	1140.18500	1140.18501	18.5–17.5	0.7283–0.689	23/32"	–
Ø 19.0 mm	1140.19000	1140.19001	19.0–18.0	0.748–0.7078	–	•
Ø 19.5 mm	1140.19500	1140.19501	19.5–18.5	0.7677–0.7283	3/4"*	–
Ø 20.0 mm	1140.20000	1140.20001	20.0–19.0	0.7874–0.748	25/32"	•
Ø 20.5 mm	1140.20500	1140.20501	20.5–19.5	0.8071–0.7677	–	–
Ø 21.0 mm	1140.21000	1140.21001	21.0–20.0	0.8268–0.7874	13/16"*	•

Included in the ER sets are all marked collets within that size and the matching collet tray ZWT

*Approx. inch sizing

For further technical information, please refer to page 295

ER standard collets and ultraprecision collets ER-UP

ER std.	ER-UP
DIN 6499-B	DIN 6499-B
ISO 15488	ISO 15488

Type	Part no.		Clamping range		Ø [inch]	Included in set
	ER standard	ER-UP	[mm]	[decimal inch]		
ER 40 [mm] continued						
Ø 21.5 mm	1140.21500	1140.21501	21.5–20.5	0.8465–0.8071	27/32"	–
Ø 22.0 mm	1140.22000	1140.22001	22.0–21.0	0.8661–0.8268	–	•
Ø 22.5 mm	1140.22500	1140.22501	22.5–21.5	0.8858–0.8465	7/8"*	–
Ø 23.0 mm	1140.23000	1140.23001	23.0–22.0	0.9055–0.8661	–	•
Ø 23.5 mm	1140.23500	1140.23501	23.5–22.5	0.9252–0.8858	29/32"	–
Ø 24.0 mm	1140.24000	1140.24001	24.0–23.0	0.9449–0.9055	15/16"	•
Ø 24.5 mm	1140.24500	1140.24501	24.5–23.5	0.9646–0.9252	–	–
Ø 25.0 mm	1140.25000	1140.25001	25.0–24.0	0.9843–0.9449	31/32"	•
Ø 25.5 mm	1140.25500	1140.25501	25.5–24.5	1.0039–0.9646	1"*	–
Ø 26.0 mm	1140.26000	1140.26001	26.0–25.0	1.0236–0.9843	–	•
Ø 27.0 mm	1140.27000	1140.27001	27.0–26.0	1.063–1.0236	1 ¹ / ₁₆ "	–
Ø 28.0 mm	1140.28000	1140.28001	28.0–27.0	1.1024–1.063	1 ³ / ₃₂ "	–
Ø 29.0 mm	1140.29000	1140.29001	29.0–28.0	1.1417–1.1024	1 ¹ / ₈ "	–
Ø 30.0 mm	1140.30000	1140.30001	30.0–29.0	1.1811–1.1417	1 ⁵ / ₃₂ "	–

ER 40 [inch]						
INCH SET ER 40	1140.00002	1140.00003	2.16–25.4	0.085–1.0	–	–
Ø 1/8"	1140.03182	1140.03183	3.18–2.16	0.125–0.085	1/8"	•
Ø 3/16"	1140.04762	1140.04763	4.76–3.75	0.1875–0.1475	3/16"	•
Ø 1/4"	1140.06352	1140.06353	6.35–5.33	0.25–0.21	1/4"	•
Ø 5/16"	1140.07942	1140.07943	7.94–6.92	0.3125–0.2725	5/16"	•
Ø 3/8"	1140.09532	1140.09533	9.53–8.51	0.375–0.335	3/8"	•
Ø 7/16"	1140.11112	1140.11113	11.11–10.1	0.4375–0.3975	7/16"	•
Ø 1/2"	1140.12702	1140.12703	12.70–11.68	0.5–0.46	1/2"	•
Ø 9/16"	1140.14292	1140.14293	14.29–13.27	0.5625–0.5225	9/16"	•
Ø 5/8"	1140.15882	1140.15883	15.88–14.86	0.625–0.585	5/8"	•
Ø 11/16"	1140.17462	1140.17463	17.46–16.45	0.6875–0.6475	11/16"	•
Ø 3/4"	1140.19052	1140.19053	19.05–18.03	0.75–0.71	3/4"	•
Ø 13/16"	1140.20642	1140.20643	20.64–19.62	0.8125–0.7725	13/16"	•
Ø 7/8"	1140.22232	1140.22233	22.23–21.21	0.875–0.835	7/8"	•
Ø 1"	1140.25402	1140.25403	25.40–24.38	1.0–0.96	1"	•

Included in the ER sets are all marked collets within that size and the matching collet tray ZWT

*Approx. inch sizing

ER standard collets and ultraprecision collets ER-UP

ER std.	ER-UP
DIN 6499-B	DIN 6499-B
ISO 15488	ISO 15488

Type	Part no.		Clamping range		Ø [inch]	Included in set
	ER standard	ER-UP	[mm]	[decimal inch]		
ER 50 [mm]						
SET ER 50	1150.00000	1150.00001	10.0–34.0	0.2362–1.3386	–	–
Ø 6.0 mm	1150.06000	1150.06001	6.0–4.0	0.2362–0.1575	3/16"	–
Ø 8.0 mm	1150.08000	1150.08001	8.0–6.0	0.315–0.2362	1/4"	–
Ø 10.0 mm	1150.10000	1150.10001	10.0–8.0	0.3937–0.315	3/8"	–
Ø 12.0 mm	1150.12000	1150.12001	12.0–10.0	0.4724–0.3937	7/16"	•
Ø 14.0 mm	1150.14000	1150.14001	14.0–12.0	0.5512–0.4724	1/2"	•
Ø 16.0 mm	1150.16000	1150.16001	16.0–14.0	0.63–0.5512	5/8"	•
Ø 18.0 mm	1150.18000	1150.18001	18.0–16.0	0.7087–0.6299	11/16"	•
Ø 20.0 mm	1150.20000	1150.20001	20.0–18.0	0.7874–0.7087	3/4"	•
Ø 22.0 mm	1150.22000	1150.22001	22.0–20.0	0.8661–0.7874	13/16"	•
Ø 24.0 mm	1150.24000	1150.24001	24.0–22.0	0.9449–0.8661	7/8"	•
Ø 25.0 mm	1150.25000	1150.25001	25.0–23.0	0.9843–0.9055	31/32"	–
Ø 26.0 mm	1150.26000	1150.26001	26.0–24.0	1.0236–0.9449	1"	•
Ø 28.0 mm	1150.28000	1150.28001	28.0–26.0	1.1024–1.0236	1 1/16"	•
Ø 30.0 mm	1150.30000	1150.30001	30.0–28.0	1.1811–1.1024	1 1/8"	•
Ø 32.0 mm	1150.32000	1150.32001	32.0–30.0	1.2598–1.1811	1 1/4"	•
Ø 34.0 mm	1150.34000	1150.34001	34.0–32.0	1.3386–1.2598	1 5/16"	•
Ø 36.0 mm	1150.36000	1150.36001	36.0–34.0	1.4173–1.3386	1 3/8"	–

Included in the ER sets are all marked collets within that size and the matching collet tray ZWT

*Approx. inch sizing

For further technical information, please refer to page 295



Type	Part no.	Clamping range		Ø [inch]	Included in set
		[mm]	[decimal inch]		
ER 11-DM [mm]					
Ø 3.0 mm	1211.03000	3.0–2.75	0.1181–0.1083	–	–
Ø 4.0 mm	1211.04000	4.0–3.75	0.1575–0.1476	–	–
Ø 5.0 mm	1211.05000	5.0–4.75	0.1969–0.187	–	–
Ø 6.0 mm	1211.06000	6.0–5.75	0.2362–0.2264	–	–
Ø 7.0 mm	1211.07000	7.0–6.75	0.2756–0.2657	–	–
ER 11-DM [inch]					
Ø 1/8"	1211.03182	3.18–2.93	0.125–0.1154	1/8"	–
Ø 3/16"	1211.04762	4.76–4.51	0.1875–0.1776	3/16"	–
Ø 7/32"	1211.05562	5.56–5.31	0.2188–0.2091	7/32"	–
Ø 1/4"	1211.06352	6.35–6.1	0.25–0.2402	1/4"	–
ER 16-DM [mm]					
SET ER 16-DM	1216.00000	3.0–10.0	0.1181–0.3937	–	–
Ø 3.0 mm	1216.03000	3.0 h9	0.1181 h9	–	•
Ø 4.0 mm	1216.04000	4.0 h9	0.1575 h9	–	•
Ø 5.0 mm	1216.05000	5.0–4.5	0.1969–0.1772	–	•
Ø 6.0 mm	1216.06000	6.0–5.5	0.2362–0.2165	–	•
Ø 7.0 mm	1216.07000	7.0–6.5	0.2756–0.2559	–	•
Ø 8.0 mm	1216.08000	8.0–7.5	0.315–0.2953	–	•
Ø 9.0 mm	1216.09000	9.0–8.5	0.3543–0.3346	–	•
Ø 10.0 mm	1216.10000	10.0–9.5	0.3937–0.374	–	•

For further technical information, please refer to page 295



Expert advice

Please note that the ER-DM collets are not suitable for use with reCool®.

Type	Part no.	Clamping range			Ø [inch]	Included in set
		[mm]	[decimal inch]			
ER 16-DM [inch]						
INCH SET ER 16-DM	1216.00002	3.18–10.32	0.125–0.4063	–	–	
Ø 1/8"	1216.03182	3.18 h9	0.125 h9	1/8"	•	
Ø 5/32"	1216.03972	3.97 h9	0.1563 h9	5/32"	–	
Ø 3/16"	1216.04762	4.76 h9	0.1875 h9	3/16"	•	
Ø 7/32"	1216.05562	5.56–5.06	0.2188–0.1991	7/32"	–	
Ø 1/4"	1216.06352	6.35–5.85	0.25–0.2303	1/4"	•	
Ø 9/32"	1216.07142	7.14–6.64	0.2813–0.2616	9/32"	–	
Ø 5/16"	1216.07942	7.94–7.44	0.3125–0.2928	5/16"	•	
Ø 11/32"	1216.08732	8.73–8.23	0.3438–0.3241	11/32"	–	
Ø 3/8"	1216.09532	9.53–9.02	0.375–0.3553	3/8"	•	
Ø 13/32"	1216.10322	10.32–9.82	0.4063–0.3866	13/32"	–	
ER 20-DM [mm]						
SET ER 20-DM	1220.00000	3.0–13.0	0.1181–0.5118	–	–	
Ø 3.0 mm	1220.03000	3.0 h9	0.1181 h9	–	•	
Ø 4.0 mm	1220.04000	4.0 h9	0.1575 h9	–	•	
Ø 5.0 mm	1220.05000	5.0 h9	0.1969 h9	–	•	
Ø 6.0 mm	1220.06000	6.0 h9	0.2362 h9	–	•	
Ø 7.0 mm	1220.07000	7.0–6.5	0.2756–0.2559	–	•	
Ø 8.0 mm	1220.08000	8.0–7.5	0.315–0.2953	–	•	
Ø 9.0 mm	1220.09000	9.0–8.5	0.3543–0.3346	–	•	
Ø 10.0 mm	1220.10000	10.0–9.5	0.3937–0.374	–	•	
Ø 11.0 mm	1220.11000	11.0–10.5	0.4331–0.4134	–	•	
Ø 12.0 mm	1220.12000	12.0–11.5	0.4724–0.4528	–	•	
Ø 13.0 mm	1220.13000	13.0–12.5	0.5118–0.4921	–	•	
ER 20-DM [inch]						
INCH SET ER 20-DM	1220.00002	3.18–12.7	0.125–0.5	–	–	
Ø 1/8"	1220.03182	3.18 h9	0.125 h9	1/8"	•	
Ø 5/32"	1220.03972	3.97 h9	0.1563 h9	5/32"	–	
Ø 3/16"	1220.04762	4.76 h9	0.1875 h9	3/16"	•	
Ø 7/32"	1220.05562	5.56 h9	0.2188 h9	7/32"	–	
Ø 1/4"	1220.06352	6.35 h9	0.25 h9	1/4"	•	
Ø 9/32"	1220.07142	7.14–6.64	0.2813–0.2616	9/32"	–	
Ø 5/16"	1220.07942	7.94–7.44	0.3125–0.2928	5/16"	•	
Ø 11/32"	1220.08732	8.73–8.23	0.3438–0.3241	11/32"	–	
Ø 3/8"	1220.09532	9.53–9.02	0.375–0.3553	3/8"	•	
Ø 13/32"	1220.10322	10.32–9.82	0.4063–0.3866	13/32"	–	
Ø 7/16"	1220.11112	11.11–10.61	0.4375–0.4178	7/16"	•	
Ø 15/32"	1220.11912	11.91–11.41	0.4687–0.4491	15/32"	–	
Ø 1/2"	1220.12702	12.7–12.2	0.5–0.4803	1/2"	•	

Type	Part no.	Clamping range		Ø [inch]	Included in set
		[mm]	[decimal inch]		
ER 25-DM [mm]					
SET ER 25-DM	1225.00000	6.0–16.0	0.2362–0.6299	–	–
Ø 6.0 mm	1225.06000	6.0 h9	0.2362 h9	–	•
Ø 7.0 mm	1225.07000	7.0 h9	0.2756 h9	–	–
Ø 8.0 mm	1225.08000	8.0–7.5	0.315–0.2953	–	•
Ø 9.0 mm	1225.09000	9.0–8.5	0.3543–0.3347	–	–
Ø 10.0 mm	1225.10000	10.0–9.5	0.3937–0.374	–	•
Ø 11.0 mm	1225.11000	11.0–10.5	0.4331–0.4134	–	–
Ø 12.0 mm	1225.12000	12.0–11.5	0.4724–0.4528	–	•
Ø 13.0 mm	1225.13000	13.0–12.5	0.5118–0.4921	–	–
Ø 14.0 mm	1225.14000	14.0–13.5	0.5512–0.5315	–	•
Ø 15.0 mm	1225.15000	15.0–14.5	0.5906–0.5709	–	–
Ø 16.0 mm	1225.16000	16.0–15.5	0.6299–0.6102	–	•
ER 25-DM [inch]					
INCH SET ER 25-DM	1225.00002	6.35–15.88	0.25–0.625	–	–
Ø 7/32"	1225.05562	5.56 h9	0.2188 h9	7/32"	–
Ø 1/4"	1225.06352	6.35 h9	0.2500 h9	1/4"	•
Ø 9/32"	1225.07142	7.14 h9	0.2813 h9	9/32"	–
Ø 5/16"	1225.07942	7.94–7.44	0.3125–0.2928	5/16"	•
Ø 11/32"	1225.08732	8.73–8.23	0.3438–0.3241	11/32"	–
Ø 3/8"	1225.09532	9.53–9.02	0.375–0.3553	3/8"	•
Ø 13/32"	1225.10322	10.32–9.82	0.4063–0.3866	13/32"	–
Ø 7/16"	1225.11112	11.11–10.61	0.4375–0.4178	7/16"	•
Ø 15/32"	1225.11912	11.91–11.41	0.4687–0.4491	15/32"	–
Ø 1/2"	1225.12702	12.7–12.2	0.5–0.4803	1/2"	•
Ø 17/32"	1225.13492	13.49–12.99	0.5313–0.5116	17/32"	–
Ø 9/16"	1225.14292	14.29–13.79	0.5625–0.5428	9/16"	•
Ø 19/32"	1225.15082	15.08–14.58	0.5934–0.5741	19/32"	–
Ø 5/8"	1225.15882	15.88–15.38	0.625–0.6055	5/8"	•
ER 32-DM [mm]					
SET ER 32-DM	1232.00000	6.0–20.0	0.2362–0.7874	–	–
Ø 6.0 mm	1232.06000	6.0 h9	0.2362 h9	–	•
Ø 7.0 mm	1232.07000	7.0 h9	0.2756 h9	–	–
Ø 8.0 mm	1232.08000	8.0–7.5	0.315–0.2953	–	•
Ø 9.0 mm	1232.09000	9.0–8.5	0.3543–0.3346	–	–
Ø 10.0 mm	1232.10000	10.0–9.5	0.3937–0.374	–	•
Ø 11.0 mm	1232.11000	11.0–10.5	0.4331–0.4134	–	–

Type	Part no.	Clamping range		Ø [inch]	Included in set
		[mm]	[decimal inch]		
Ø 12.0 mm	1232.12000	12.0–11.5	0.4724–0.4528	–	•
Ø 13.0 mm	1232.13000	13.0–12.5	0.5118–0.4921	–	–
Ø 14.0 mm	1232.14000	14.0–13.5	0.5512–0.5315	–	•
Ø 15.0 mm	1232.15000	15.0–14.5	0.5906–0.5709	–	–
Ø 16.0 mm	1232.16000	16.0–15.5	0.6299–0.6102	–	•
Ø 17.0 mm	1232.17000	17.0–16.5	0.6693–0.6496	–	–
Ø 18.0 mm	1232.18000	18.0–17.5	0.7087–0.689	–	•
Ø 19.0 mm	1232.19000	19.0–18.5	0.748–0.7283	–	–
Ø 20.0 mm	1232.20000	20.0–19.5	0.7874–0.7677	–	•

ER 32-DM [inch]

INCH SET ER 32-DM	1232.00002	6.35–19.05	0.25–0.75	–	–
Ø 1/4"	1232.06352	6.35 h9	0.25 h9	1/4"	•
Ø 9/32"	1232.07142	7.15 h9	0.2813 h9	9/32"	–
Ø 5/16"	1232.07942	7.94–7.44	0.3125–0.2928	5/16"	•
Ø 11/32"	1232.08732	8.73–8.23	0.3438–0.3241	11/32"	–
Ø 3/8"	1232.09532	9.53–9.02	0.375–0.3553	3/8"	•
Ø 13/32"	1232.10322	10.32–9.82	0.4063–0.3866	13/32"	–
Ø 7/16"	1232.11112	11.11–10.61	0.4375–0.4178	7/16"	•
Ø 15/32"	1232.11912	11.91–11.41	0.4687–0.4491	15/32"	–
Ø 1/2"	1232.12702	12.7–12.2	0.5–0.4803	1/2"	•
Ø 17/32"	1232.13492	13.5–12.99	0.5313–0.5116	17/32"	–
Ø 9/16"	1232.14292	14.29–13.79	0.5625–0.5428	9/16"	•
Ø 19/32"	1232.15082	15.07–14.58	0.5934–0.5741	19/32"	–
Ø 5/8"	1232.15882	15.88–15.38	0.625–0.6055	5/8"	•
Ø 21/32"	1232.16672	16.67–16.17	0.6563–0.6366	21/32"	–
Ø 11/16"	1232.17462	17.46–16.96	0.6875–0.6678	11/16"	•
Ø 23/32"	1232.18262	18.26–17.76	0.7188–0.6991	23/32"	–
Ø 3/4"	1232.19052	19.05–18.55	0.75–0.7303	3/4"	•

ER 40-DM [mm]

Ø 6.0 mm	1240.06000	6.0 h9	0.2362 h9	–	–
Ø 8.0 mm	1240.08000	8.0 h9	0.3150 h9	–	–
Ø 10.0 mm	1240.10000	10.0–9.5	0.3937–0.374	–	–
Ø 11.0 mm	1240.11000	11.0–10.5	0.4331–0.4134	–	–
Ø 12.0 mm	1240.12000	12.0–11.5	0.4724–0.4528	–	–
Ø 13.0 mm	1240.13000	13.0–12.5	0.5118–0.4921	–	–
Ø 14.0 mm	1240.14000	14.0–13.5	0.5512–0.5315	–	–
Ø 15.0 mm	1240.15000	15.0–14.5	0.5906–0.5709	–	–

For further technical information, please refer to page 295

Type	Part no.	Clamping range		Ø [inch]	Included in set
		[mm]	[decimal inch]		
ER 40-DM [mm] continued					
Ø 16.0 mm	1240.16000	16.0–15.5	0.6299–0.6102	–	–
Ø 17.0 mm	1240.17000	17.0–16.5	0.6693–0.6496	–	–
Ø 18.0 mm	1240.18000	18.0–17.5	0.7087–0.689	–	–
Ø 19.0 mm	1240.19000	19.0–18.5	0.748–0.7283	–	–
Ø 20.0 mm	1240.20000	20.0–19.5	0.7874–0.7677	–	–
Ø 21.0 mm	1240.21000	21.0–20.5	0.8268–0.8071	–	–
Ø 22.0 mm	1240.22000	22.0–21.5	0.8661–0.8465	–	–
Ø 23.0 mm	1240.23000	23.0–22.5	0.9055–0.8858	–	–
Ø 24.0 mm	1240.24000	24.0–23.5	0.9449–0.9252	–	–
Ø 25.0 mm	1240.25000	25.0–24.5	0.9843–0.9646	–	–
Ø 26.0 mm	1240.26000	26.0–25.5	1.0236–1.0039	–	–
ER 40-DM [inch]					
Ø 1/4"	1240.06352	6.35 h9	0.25 h9	1/4"	–
Ø 5/16"	1240.07942	7.94 h9	0.3125 h9	5/16"	–
Ø 3/8"	1240.09532	9.53–9.02	0.375–0.3553	3/8"	–
Ø 7/16"	1240.11112	11.11–10.61	0.4375–0.4178	7/16"	–
Ø 1/2"	1240.12702	12.7–12.2	0.5–0.4803	1/2"	–
Ø 9/16"	1240.14292	14.29–13.79	0.5625–0.5428	9/16"	–
Ø 5/8"	1240.15882	15.88–15.38	0.62–0.6055	5/8"	–
Ø 11/16"	1240.17462	17.46–16.96	0.6875–0.6678	11/16"	–
Ø 3/4"	1240.19052	19.05–18.55	0.75–0.7303	3/4"	–
Ø 13/16"	1240.20642	20.64–20.14	0.8123–0.7928	13/16"	–
Ø 7/8"	1240.22232	22.23–21.72	0.875–0.8553	7/8"	–
Ø 1"	1240.25402	25.4–24.9	1.0–0.9803	1"	–

For further technical information, please refer to page 295.

Expert advice

Please note that DM collets are not compatible with Weldon or Whistle notch shafts. To achieve internal cooling with Weldon or Whistle notch shafts, use the REGO-FIX sealing disks ER/DS with your REGO-FIX ER collet.

secuRgrip® collets ER-SG

ER-SG

DIN 6499

ISO 15488

Type	Part no.	[mm]	Ø [inch]
ER 32-SG [mm]			
Ø 10.0 mm	1332.10004	10	–
Ø 12.0 mm	1332.12004	12	–
Ø 16.0 mm	1332.16004	16	–

ER 32-SG [inch]			
Ø 1/2"	1332.12704	12.7	1/2"
Ø 5/8"	1332.15884	15.88	5/8"

ER 40-SG [mm]			
Ø 16.0 mm	1340.16004	16	–
Ø 20.0 mm	1340.20004	20	–
Ø 25.0 mm	1340.25004	25	–

ER 40-SG [inch]			
Ø 5/8"	1340.15884	15.88	5/8"
Ø 3/4"	1340.19054	19.05	3/4"
Ø 1"	1340.25404	25.4	1"

Threaded insert SGI [mm]	
Ø 10.0 mm	7694.10000
Ø 12.0 mm	7694.12000
Ø 14.0 mm	7694.14000
Ø 16.0 mm	7694.16000
Ø 18.0 mm	7694.18000
Ø 20.0 mm	7694.20000
Ø 25.0 mm	7694.25000

Threaded insert SGI [inch]	
Ø 1/2"	7694.12700
Ø 5/8"	7694.15880
Ø 3/4"	7694.19050
Ø 1"	7694.25400

[Learn more](#)

For further information on secuRgrip®, please refer to page 277.



ER tapping collets ER-GB

Manufactured with a form-fitting internal square, the ER-GB collets successfully prevent the tap from slipping.

Tapping collets without axial compensation

Swiss quality

Made in Switzerland to ISO 9001 / ISO 14001.

Marking

Type and size (reduced collet selection errors).

Traceability

Lot number marking on all products for traceability through the entire manufacturing process.

Original REGO-FIX

Our long-lasting machining experience results in a well-engineered system. When buying REGO-FIX products pay attention to our quality seal: The triangle is our seal for outstanding quality made in Switzerland.

Interchangeable

With standard ER collet DIN 6499 / ISO 15488. No additional toolholders and clamping nuts necessary.

Wide product range

Sizes: ER-GB 11 to 50.
Standards: DIN, ISO, JIS, ANSI.

Strength: Square for tight grip of tap

Eliminates tap slippage in collets.

Matched tooling system for best fit

The compatibility of the entire system results in maximum precision, balance and tool life.

Tapping collets ER-GB These rigid tapping collets are compatible with taps per DIN, ISO, JIS and ANSI standards. The REGO-FIX ER-GB tapping collets are manufactured with an internal square. They are intended for use on CNC machines that have synchronized machine spindle speed and feed rate. Machines that have such rigid tapping capabilities require only minimal compensation. We recommend the use of our SSY Softsynchro® tapping holders. They compensate minimal synchronizing differences of CNC machines.

For machines without tapping option we recommend the use of our axial compensating GSF tapping holders. Please refer to page 116 for more information. For additional technical information and dimensions of taps on ER-GB, please refer to pages 299 and 336.

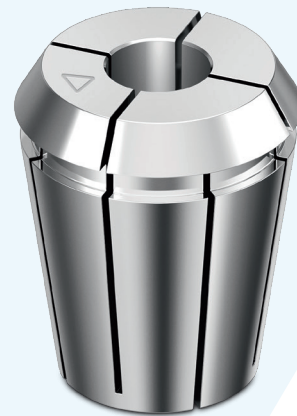

ER-GB

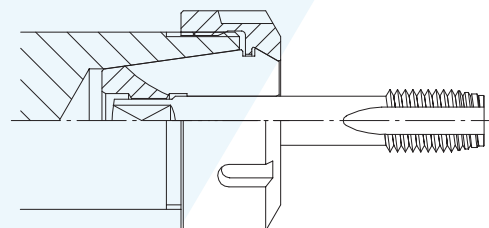

ER-GB

ER tapping collets

ER-GB

ER-GB [mm]

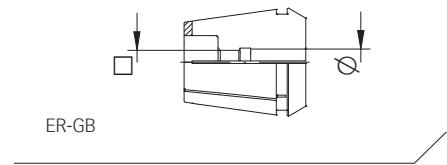

Dimensions [mm]		ER-GB								
Ø	□	11	16	20	25	32	40	50	Standard	
2.5	2.1/2.0	1411.02500	-	-	-	-	-	-	DIN / ISO	
2.8	2.1	1411.02800	1416.02800	-	-	-	-	-	DIN	
3.5	2.7	1411.03500	1416.03500	1420.03500	-	-	-	-	DIN	
4.0	3.0	1411.04000	-	-	-	-	-	-	DIN	
4.0	3.15/3.2	1411.04002	1416.04002	1420.04002	1425.04002	1432.04002	-	-	ISO / JIS	
4.5	3.4	1411.04500	1416.04500	1420.04500	1425.04500	1432.04500	-	-	DIN	
5.0	4.0	1411.05002	1416.05002	1420.05002	1425.05002	1432.05002	-	-	ISO / JIS	
5.5	4.3	-	1416.05500	1420.05500	1425.05500	1432.05500	-	-	DIN	
5.5	4.5	-	1416.05501	1420.05501	1425.05501	1432.05501	-	-	JIS	
6.0	4.5	-	1416.06001	1420.06001	1425.06001	1432.06001	1440.06001	-	JIS	
6.0	4.9	1411.06000	1416.06000	1420.06000	1425.06000	1432.06000	1440.06000	-	DIN	
6.2	5.0	-	1416.06201	1420.06201	1425.06201	1432.06201	1440.06201	-	JIS	
6.3	5.0	-	1416.06302	1420.06302	1425.06302	1432.06302	1440.06302	-	ISO	
7.0	5.5	-	1416.07000	1420.07000	1425.07000	1432.07000	1440.07000	-	DIN / JIS	
7.1	5.6	-	1416.07102	1420.07102	1425.07102	1432.07102	1440.07102	-	ISO	
8.0	6.2/6.3	-	1416.08000	1420.08000	1425.08000	1432.08000	1440.08000	-	DIN / ISO	
8.5	6.5	-	1416.08501	1420.08501	1425.08501	1432.08501	1440.08501	-	JIS	
9.0	7.0/7.1	-	1416.09000	1420.09000	1425.09000	1432.09000	1440.09000	-	DIN / ISO	
10.0	8.0	-	-	1420.10000	1425.10000	1432.10000	1440.10000	-	DIN / ISO	
10.5	8.0	-	-	1420.10501	1425.10501	1432.10501	1440.10501	-	JIS	
11.0	9.0	-	-	1420.11000	1425.11000	1432.11000	1440.11000	-	DIN	
11.2	9.0	-	-	1420.11202	1425.11202	1432.11202	1440.11202	-	ISO	
12.0	9.0	-	-	1420.12000	1425.12000	1432.12000	1440.12000	-	DIN	
12.5	10.0	-	-	-	1425.12502	1432.12502	1440.12502	-	ISO / JIS	
14.0	11.0/11.2	-	-	-	1425.14000	1432.14000	1440.14000	-	DIN / ISO / JIS	
15.0	12.0	-	-	-	1425.15001	1432.15001	1440.15001	-	JIS	
16.0	12.0/12.5	-	-	-	1425.16000	1432.16000	1440.16000	-	DIN / ISO	
17.0	13.0	-	-	-	-	1432.17001	1440.17001	-	JIS	
18.0	14.0/14.5	-	-	-	-	1432.18000	1440.18000	-	DIN / ISO	
20.0	16.0	-	-	-	-	1432.20000	1440.20000	-	DIN / ISO	
22.0	18.0	-	-	-	-	-	1440.22000	1450.22000	DIN	
25.0	20.0	-	-	-	-	-	-	1450.25000	DIN	
28.0	22.0	-	-	-	-	-	-	1450.28000	DIN	
32.0	24.0	-	-	-	-	-	-	1450.32000	DIN	

ER tapping collets

ER-GB

ER-GB [inch]

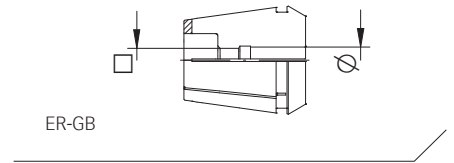

Dimensions [decimal inch]								ER-GB		Standard
Ø	□	11	16	20	25	32	40	50		
0.141"	0.11"	1411.03585	1416.03585	-	-	-	-	-	ANSI	
0.168"	0.131"	1411.04275	1416.04275	1420.04275	1425.04275	1432.04275	-	-	ANSI	
0.194"	0.152"	1411.04935	1416.04935	1420.04935	1425.04935	1432.04935	-	-	ANSI	
0.22"	0.165"	-	1416.05595	1420.05595	1425.05595	1432.05595	-	-	ANSI	
0.255"	0.191"	-	1416.06485	1420.06485	1425.06485	1432.06485	1440.06485	-	ANSI	
0.318"	0.238"	-	1416.08085	1420.08085	1425.08085	1432.08085	1440.08085	-	ANSI	
0.323"	0.242"	-	-	1420.08215	1425.08215	1432.08215	1440.08215	-	ANSI	
0.367"	0.275"	-	-	1420.09325	1425.09325	1432.09325	1440.09325	-	ANSI	
0.381"	0.286"	-	-	1420.09685	1425.09685	1432.09685	1440.09685	-	ANSI	
0.429"	0.322"	-	-	-	1425.10905	1432.10905	1440.10905	-	ANSI	
0.437"	0.328"	-	-	-	1425.11104	1432.11104	1440.11104	-	ANSI/NPT	
0.48"	0.36"	-	-	-	1425.12195	1432.12195	1440.12195	-	ANSI	
0.542"	0.406"	-	-	-	-	1432.13775	1440.13775	-	ANSI	
0.562"	0.421"	-	-	-	-	1432.14274	1440.14274	-	ANSI/NPT	
0.59"	0.442"	-	-	-	1425.14995	1432.14995	1440.14995	-	ANSI	
0.652"	0.489"	-	-	-	-	1432.16565	1440.16565	-	ANSI	
0.687"	0.515"	-	-	-	-	-	1440.17454	-	ANSI/NPT	
0.697"	0.523"	-	-	-	-	-	1440.17705	-	ANSI	
0.7"	0.531"	-	-	-	-	-	1440.17784	-	ANSI/NPT	
0.76"	0.57"	-	-	-	-	-	1440.19305	-	ANSI	
0.800"	0.600"	-	-	-	-	-	1440.20325	1450.20325	ANSI	
0.896"	0.672"	-	-	-	-	-	-	1450.22765	ANSI	
1.021"	0.766"	-	-	-	-	-	-	1450.25935	ANSI	
1.108"	0.831"	-	-	-	-	-	-	1450.28145	ANSI	
1.233"	0.925"	-	-	-	-	-	-	1450.31325	ANSI	

Thread	Ø [inch]	□
No 0 – 6	0.141	0.110
1/16	0.141	0.110
3/32	0.141	0.110
1/8	0.141	0.110
5/32	0.168	0.131
No 8	0.168	0.131
3/16	0.194	0.152
No 9	0.194	0.152

Thread	Ø [inch]	□
No 10	0.194	0.152
1/4	0.255	0.191
5/16	0.318	0.238
3/8	0.381	0.286
7/16	0.323	0.242
1/2	0.367	0.275
9/16	0.429	0.322

Thread	Ø [inch]	□
5/8	0.480	0.360
11/16	0.542	0.406
3/4	0.590	0.442
13/16	0.652	0.489
7/8	0.697	0.523
15/16	0.760	0.570
1	0.800	0.600

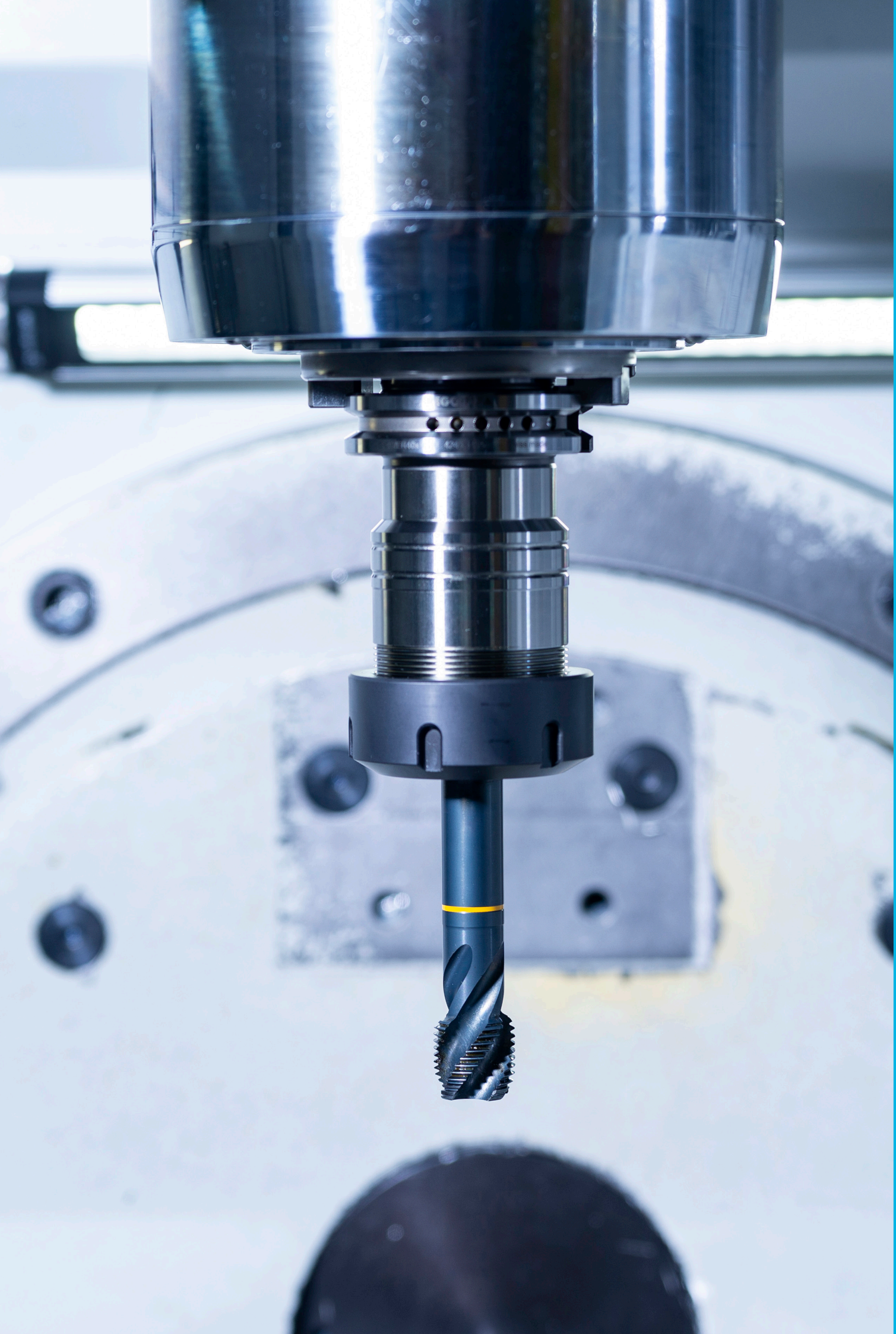

ER tapping collets PCM ET1

PCM ET1 tapping collets with axial compensation offer a smart and cost-effective toolholding option for machines which need axial compensation for tapping.

Tapping collets with axial compensation

Interchangeable

With REGO-FIX standard ER collet DIN 6499 / ISO 15488.

Compatibility

PCM ET1-12 is compatible with ER11 toolholders.

Cost saving

No expensive tapping tools necessary.

Spring tension

Adapted to tap size.

Compact

Very robust design with smallest space requirement.

Directions for use The following tapping process is recommended for tapping collets PCM ET1: Fast approach, then tapping feed with approximately 95% of the pitch value, which uses 20 to 30% of the compensation stroke when the spindle rotation and the feed movement are simultaneously reversed.

Return feed must be made with 100% of the pitch, which maintains the sleeve of the tapping collet in the compensation stroke up to the tap disengagement; quick return can then be programmed with usual stroke security. The relatively long axial compensation assists easy programming.

When tapping with very high speed, an appropriate programming compensation may be necessary to balance the differences of inertia between the spindle and the feed movement on reverse. In order to not disturb the axial compensation, use external coolant supply only.

Please refer to page 116 for additional information on REGO-FIX tapping holders. For additional technical information and dimensions of taps on PCM ET1, please refer to pages 300.

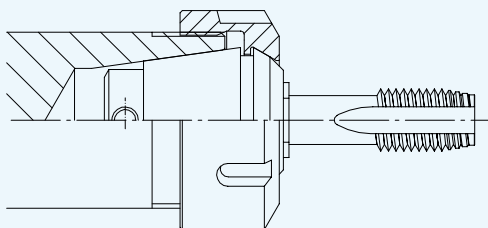

PCM ET1



PCM ET1

Expert advice

Not for coolant through tools and not for applications with sealing disks.

Expert advice

Further information about shaft diameters can be found on page 336.

ER tapping collets

PCM ET1

PCM ET1 [mm]

Shank Ø [mm]	PCM ET1						Standard
	12	16	20	25	32	40	
1.4	1512.01400	1516.01400	–	–	–	–	DIN/ISO
1.6	1512.01600	1516.01600	–	–	–	–	DIN
1.8	1512.01800	1516.01800	–	–	–	–	DIN
2.0	1512.02000	1516.02000	–	–	–	–	DIN
2.2	1512.02200	1516.02200	1520.02200	–	–	–	ISO/JIS
2.24	1512.02240	1516.02240	1520.02240	–	–	–	DIN
2.5	1512.02500	1516.02500	1520.02500	1525.02500	–	–	ISO/JIS
2.8	1512.02800	1516.02800	1520.02800	1525.02800	–	–	DIN
3.0	1512.03000	1516.03000	1520.03000	1525.03000	–	–	JIS
3.15	1512.03150	1516.03150	1520.03150	1525.03150	–	–	JIS
3.5	1512.03500	1516.03500	1520.03500	1525.03500	–	–	DIN
3.55	1512.03550	1516.03550	1520.03550	1525.03550	–	–	JIS
4.0	–	1516.04000	1520.04000	1525.04000	–	–	ISO
4.5	–	1516.04500	1520.04500	1525.04500	1532.04500	–	DIN/JIS
5.0	–	1516.05000	1520.05000	1525.05000	1532.05000	–	ISO
5.5	–	1516.05500	1520.05500	1525.05500	1532.05500	–	DIN/ISO
5.6	–	1516.05600	1520.05600	1525.05600	1532.05600	–	JIS
6.0	–	1516.06000	1520.06000	1525.06000	1532.06000	1540.06000	DIN/ISO
6.2	–	1516.06200	1520.06200	1525.06200	1532.06200	1540.06200	DIN/ISO
6.3	–	1516.06300	1520.06300	1525.06300	1532.06300	1540.06300	JIS
7.0	–	–	1520.07000	1525.07000	1532.07000	1540.07000	DIN
7.1	–	–	–	1525.07100	1532.07100	1540.07100	ISO
8.0	–	–	–	1525.08000	1532.08000	1540.08000	DIN
8.5	–	–	–	1525.08500	1532.08500	1540.08500	ISO/JIS
9.0	–	–	–	1525.09000	1532.09000	1540.09000	DIN/ISO/JIS
10.0	–	–	–	1525.10000	1532.10000	1540.10000	JIS
10.5	–	–	–	–	1532.10500	1540.10500	DIN/ISO
11.0	–	–	–	–	1532.11000	1540.11000	JIS
11.2	–	–	–	–	1532.11200	1540.11200	DIN/ISO
12.0	–	–	–	–	1532.12000	1540.12000	DIN/ISO
12.5	–	–	–	–	1532.12500	1540.12500	DIN
14.0	–	–	–	–	–	1540.14000	DIN
15.0	–	–	–	–	–	1540.15000	DIN
16.0	–	–	–	–	–	1540.16000	DIN
17.0	–	–	–	–	–	1540.17000	JIS

PCM ET1-ER 12 is technically identical to ER 11 and fits all ER11 toolholders

ER tapping collets

PCM ET1

PCM ET1 [inch]

Shank Ø		PCM ET1					
[inch]	[mm]	12	16	20	25	32	40
0.141	3.580	1512.03581	1516.03581	1520.03581	1525.03581	–	–
0.168	4.270	–	1516.04271	1520.04271	1525.04271	1532.04721	–
0.194	4.930	–	1516.04931	1520.04931	1525.04931	1532.04931	–
0.220	5.590	–	1516.05591	1520.05591	1525.05591	1532.05591	–
0.255	6.480	–	–	1520.06481	1525.06481	1532.06481	1540.06481
0.318	8.080	–	–	–	1525.08081	1532.08081	1540.08081
0.323	8.205	–	–	–	1525.08211	1532.08211	1540.08211
0.367	9.320	–	–	–	1525.09321	1532.09321	1540.09321
0.381	9.680	–	–	–	1525.09681	1532.09681	1540.09681
0.429	10.900	–	–	–	–	1532.10901	1540.10901
0.437	11.113	–	–	–	–	1532.11111	1540.11111
0.480	12.192	–	–	–	–	1532.12191	1540.12191
0.542	13.770	–	–	–	–	–	1540.13771
0.562	14.290	–	–	–	–	–	1540.14291
0.590	14.990	–	–	–	–	–	1540.14991
0.652	16.560	–	–	–	–	–	1540.16561
0.697	17.700	–	–	–	–	–	1540.17701

PCM ET1-ER 12 is technically identical to ER 11 and fits all ER11 toolholders

Thread	Ø [inch]	□
No 0 – 6	0.141	0.110
1/16	0.141	0.110
3/32	0.141	0.110
1/8	0.141	0.110
5/32	0.168	0.131
No 8	0.168	0.131
3/16	0.194	0.152
No 9	0.194	0.152

Thread	Ø [inch]	□
No 10	0.194	0.152
1/4	0.255	0.191
5/16	0.318	0.238
3/8	0.381	0.286
7/16	0.323	0.242
1/2	0.367	0.275
9/16	0.429	0.322

Thread	Ø [inch]	□
5/8	0.480	0.360
11/16	0.542	0.406
3/4	0.590	0.442
13/16	0.652	0.489
7/8	0.697	0.523
15/16	0.760	0.570
1	0.800	0.600





Standard		Standard with bearing		Mini nut		Slip-off proof mini nut		External Thread			Sealing and coolant flush disks		
Hi-Q®/ER	Hi-Q®/ERC	Hi-Q®/ERB	Hi-Q®/ERBC	Hi-Q®/ERM	Hi-Q®/ERMC	Hi-Q®/ERMX intRlox®	Hi-Q®/ERMXC intRlox®	ER MS	Hi-Q®/ERAX	Hi-Q®/ERAXC	reCool® RCR/RCS	DS/ER	KS/ER
page 160	page 162	page 164	page 164	page 166	page 166	page 168	page 168	page 170	page 172	page 172	page 174	page 244	page 252

B: bearing C: cooling M: mini thread X: slip-off proof

DS: sealing disk KS: coolant flush disk

Swiss quality ER clamping nuts

ER nuts



Hi-Q®/ER



Hi-Q®/ERB

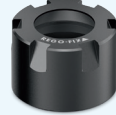

Hi-Q®/ERM



Hi-Q®/ERMx intrRlox®

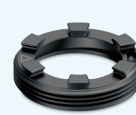

Hi-Q®/ERAX

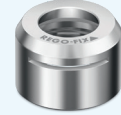

ER MS

Main feature	standard nut	with friction-bearing for higher clamping force	mini clamping nut	slip-off proof mini clamping nut	external thread and slip-off proof	up to 80,000 rpm
Sizes	ER 11–ER 50	ER 16–ER 50	ER 8–ER 25	ER 8–ER 25	ER 11–ER 40	ER 8–ER 20
Compatibility	compatible with all REGO-FIX ER collets					
Minimal outer diameter	–	–	•	•	–	•
Slip-off proof	–	–	–	•	•	–
Surface protection	•	•	•	•	•	–
Suitable wrench	A-E, E P, E, A-E P	A-E, E P, E, A-E P	A-E M, E M	A-E MX, E MX	A-E AX, E AX	A-E MS, E MS
Collet Locking System*	•	•	•	•	•	–

A: external thread B: bearing M: mini thread X: slip-off proof

*Collet Locking System is not available for size 8

ER nuts Type C for coolant through



Hi-Q®/ERC

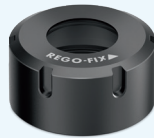

Hi-Q®/ERBC



Hi-Q®/ERM C



Hi-Q®/ERMx C intrRlox®

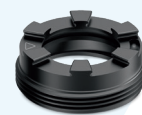

Hi-Q®/ERAX C

Main feature	standard nut	with friction-bearing for higher clamping force	mini clamping nut	slip-off proof mini clamping nut	external thread and slip-off proof
Cooling option	internal cooling with DS disks and peripheral cooling with KS disks to 150 bar / 2100 PSI				
Sizes	ER 11–ER 50	ER 16–ER 50	ER 11–ER 25	ER 11–ER 25	ER 11–ER 40
Compatibility	compatible with all REGO-FIX ER collets, except PCM ET1 collets				
Minimal outer diameter	–	–	•	•	–
Slip-off proof	–	–	–	•	•
Surface protection	•	•	•	•	•
Suitable wrench	A-E, E P, E, A-E P	A-E, E P, E, A-E P	A-E M, E M	A-E MX, E MX	A-E AX, E AX
Collet Locking System*	•	•	•	•	•

A: external thread B: bearing C: cooling M: mini thread X: slip-off proof

Expert advice

We recommend tightening the clamping nuts with our TORCO-BLOCK or torque wrench.

For more information on TORCO-BLOCK, see page 262. For tightening torque recommendations, please refer to page 293.

Hi-Q®/ER standard clamping nuts

Standard Hi-Q®/ER clamping nuts with corrosion-resistant surface are the standard nuts on all REGO-FIX ER toolholders.

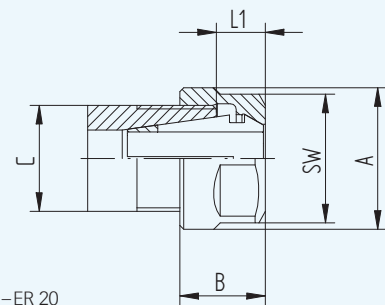

Hi-Q®/ER 11-ER 20

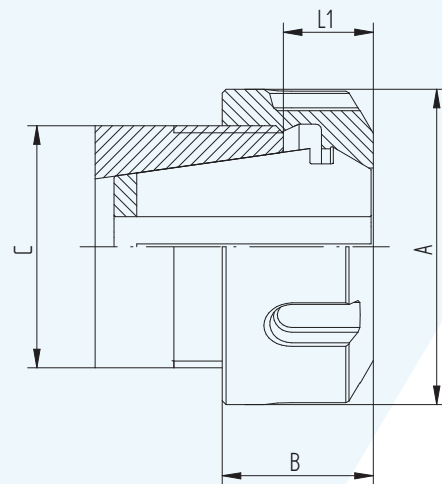

Hi-Q®/ER 25-ER 50

Expert advice

Higher clamping force of the clamping nut at the same time means higher stress on the toolholder. We recommend the use of REGO-FIX torque wrench. REGO-FIX will not be responsible for damages to toolholders or spindles of other manufacturers.

Type	Part no.	Dimensions [mm]					Accessory	
		A	B	L1	SW	C	Wrench	
Hi-Q®/ER 11								
Hi-Q®/ER 11	3411.00000	19	11.3	4.9–6.6	17	M 14 x 0.75	E 11 P	
Hi-Q®/ER 11 L	3411.02000	19	11.3	4.9–6.6	17	M 14 x 0.75-LH	E 11 P	
Hi-Q®/ER 16								
Hi-Q®/ER 16	3416.00000	28	17.5	7.0–10.5	25	M 22 x 1.5	E 16 P	
Hi-Q®/ER 16 L	3416.02000	28	17.5	7.0–10.5	25	M 22 x 1.5-LH	E 16 P	
Hi-Q®/ER 20								
Hi-Q®/ER 20	3420.00000	34	19	8.0–11.5	30	M 25 x 1.5	E 20 P	
Hi-Q®/ER 20 L	3420.02000	34	19	8.0–11.5	30	M 25 x 1.5-LH	E 20 P	
Hi-Q®/ER 25								
Hi-Q®/ER 25	3425.00000	42	20	8.5–12.0	–	M 32 x 1.5	E 25	
Hi-Q®/ER 25 L	3425.02000	42	20	8.5–12.0	–	M 32 x 1.5-LH	E 25	
Hi-Q®/ER 32								
Hi-Q®/ER 32	3432.00000	50	22.5	9.5–13.0	–	M 40 x 1.5	E 32	
Hi-Q®/ER 32 L	3432.02000	50	22.5	9.5–13.0	–	M 40 x 1.5-LH	E 32	
Hi-Q®/ER 40								
Hi-Q®/ER 40	3440.00000	63	25.5	11.5–15.0	–	M 50 x 1.5	E 40	
Hi-Q®/ER 40 L	3440.02000	63	25.5	11.5–15.0	–	M 50 x 1.5-LH	E 40	
Hi-Q®/ER 50								
Hi-Q®/ER 50	3450.00000	78	35.3	14.0–21.0	–	M 64 x 2	E 50	

L = left-threaded nuts

Hi-Q®/ERC for coolant through tools

Application with sealing disk/coolant flush disk The Hi-Q®/ERC clamping nut is intended for use with the sealing disk system DS/ER and the cool flush system KS/ER. The disk system allows the use of all standard ER collets, ultraprecision collets and tapping collets for coolant through tools.

- // Up to 150 bar / 2100 PSI coolant pressure
- // Prevents dirt and chips from entering the collet

For peripheral cooling of non coolant through tools we recommend the coolant flush disks KS/ER. Please refer to page 252. Accessories are not included in delivery.

Hi-Q®/ERC 11 This clamping nut is recommended for use where minimal external diameters are important. The Hi-Q®/ERC 11 clamping nut for coolant through tools is the internal cooling version of the Hi-Q®/ER 11 clamping nut

Hi-Q®/ERC 11 does not require sealing disks The sealing system is built into the clamping nut.

- // Up to 150 bar / 2100 PSI coolant pressure
- // Prevents dirt and chips from entering the collet

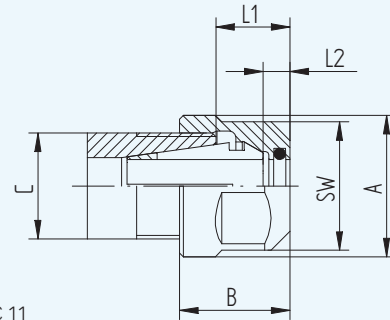
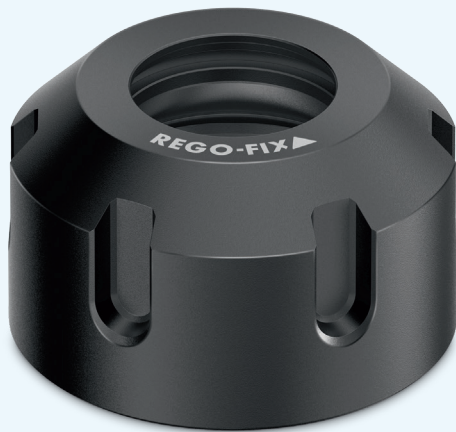

Hi-Q®/ERC 11

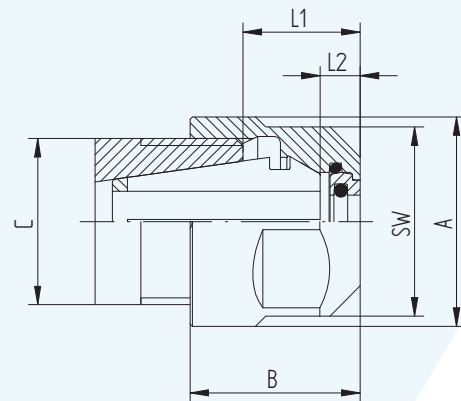

Hi-Q®/ERC 16 – ERC 20

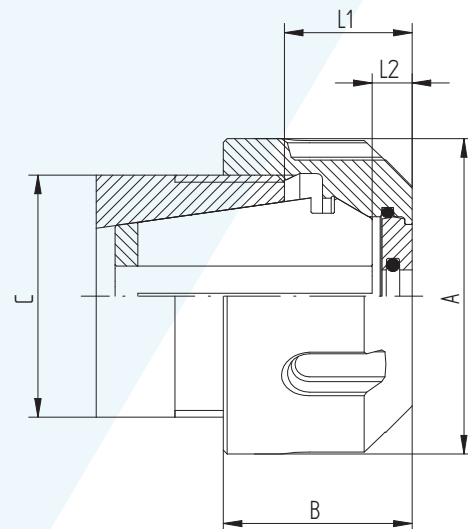

Hi-Q®/ERC 25 – ERC 50

Type	Part no.	Dimensions [mm]						C	Bore-Ø		Accessory
		A	B	L1	L2	SW	[mm]		[inch]	Wrench	
Hi-Q®/ERC 11											
Hi-Q®/ERC 11, Ø 3.0 mm	3411.20300	19	14.6	8.1–9.8	3.5	17	M 14 x 0.75	3.0–2.5	3/32"	E 11 P	
Hi-Q®/ERC 11, Ø 3.5 mm	3411.20350	19	14.6	8.1–9.8	3.5	17	M 14 x 0.75	3.5–3.0	1/8"	E 11 P	
Hi-Q®/ERC 11, Ø 4.0 mm	3411.20400	19	14.6	8.1–9.8	3.5	17	M 14 x 0.75	4.0–3.5	5/32"	E 11 P	
Hi-Q®/ERC 11, Ø 4.5 mm	3411.20450	19	14.6	8.1–9.8	3.5	17	M 14 x 0.75	4.5–4.0	–	E 11 P	
Hi-Q®/ERC 11, Ø 5.0 mm	3411.20500	19	14.6	8.1–9.8	3.5	17	M 14 x 0.75	5.0–4.5	3/16"	E 11 P	
Hi-Q®/ERC 11, Ø 5.5 mm	3411.20550	19	14.6	8.1–9.8	3.5	17	M 14 x 0.75	5.5–5.0	7/32"	E 11 P	
Hi-Q®/ERC 11, Ø 6.0 mm	3411.20600	19	14.6	8.1–9.8	3.5	17	M 14 x 0.75	6.0–5.5	–	E 11 P	
Hi-Q®/ERC 11, Ø 6.5 mm	3411.20650	19	14.6	8.1–9.8	3.5	17	M 14 x 0.75	6.5–6.0	1/4"	E 11 P	
Hi-Q®/ERC 11, Ø 7.0 mm	3411.20700	19	14.6	8.1–9.8	3.5	17	M 14 x 0.75	7.0–6.5	–	E 11 P	
Hi-Q®/ERC 11											
Hi-Q®/ERC 11	3411.20000	19	14.6	8.1–9.8	3.5	17	M 14 x 0.75	3.0–6.0	–	E 11 P	
Hi-Q®/ERC 16											
Hi-Q®/ERC 16	3416.20000	25	22.5	12.0–15.5	5	25	M 22 x 1.5	22.5	–	E 16 P	
Hi-Q®/ERC 20											
Hi-Q®/ERC 20	3420.20000	34	24	13.0–16.5	5	30	M 25 x 1.5	24	–	E 20 P	
Hi-Q®/ERC 25											
Hi-Q®/ERC 25	3425.20000	42	25	13.5–17.0	5	–	M 32 x 1.5	25	–	E 25	
Hi-Q®/ERC 32											
Hi-Q®/ERC 32	3432.20000	50	27.5	14.5–18.0	5	–	M 40 x 1.5	27.5	–	E 32	
Hi-Q®/ERC 40											
Hi-Q®/ERC 40	3440.20000	63	30.5	16.5–20.0	5	–	M 50 x 1.5	30.5	–	E 40	
Hi-Q®/ERC 50											
Hi-Q®/ERC 50	3450.20000	78	42.5	19.0–26.0	5	–	M 64 x 2	40.3	–	E 50	

Hi-Q®/ERB friction-bearing Hi-Q®/ERBC for coolant through tools

Application The Hi-Q®/ERB is a friction-bearing nut that offers the highest clamping force available. It is interchangeable with all other nuts per DIN 6499.

Application with sealing disk/coolant flush disk The Hi-Q®/ERBC clamping nut is intended for use with the sealing disk system DS/ER and the cool flush system KS/ER. The disk system allows the use of all standard ER collets, ultraprecision collets and tapping collets for coolant through tools.

- // Up to 150 bar / 2100 PSI coolant pressure
- // Prevents dirt and chips from entering the collet

For peripheral cooling of non coolant through tools we recommend the coolant flush disks KS/ER. Please refer to page 252. Accessories are not included in delivery.

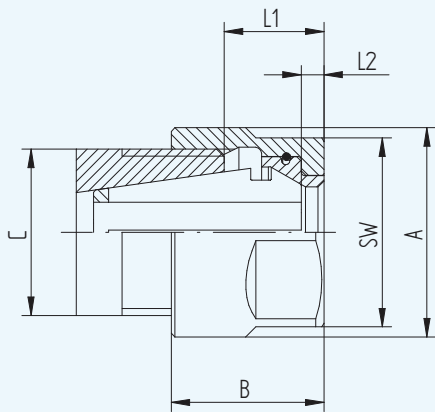

Hi-Q®/ERB 16 – ERB 20

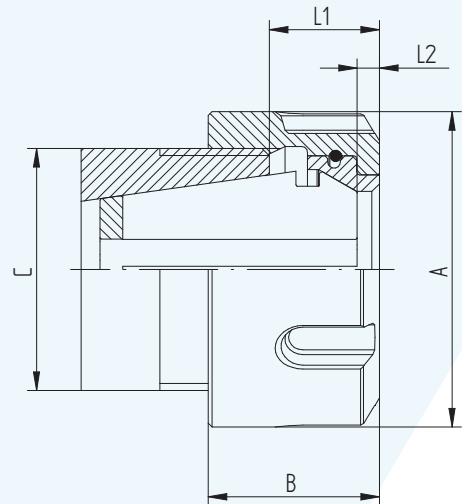

Hi-Q®/ERB 25 – ERB 50

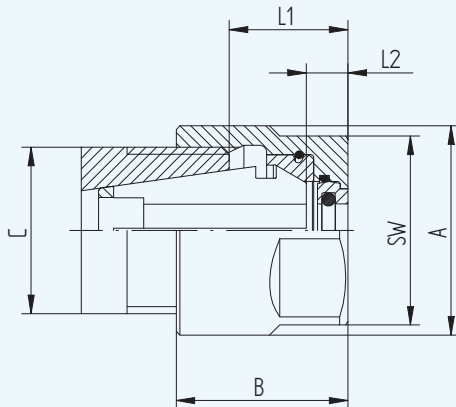

Hi-Q®/ERBC 16 – ERBC 20

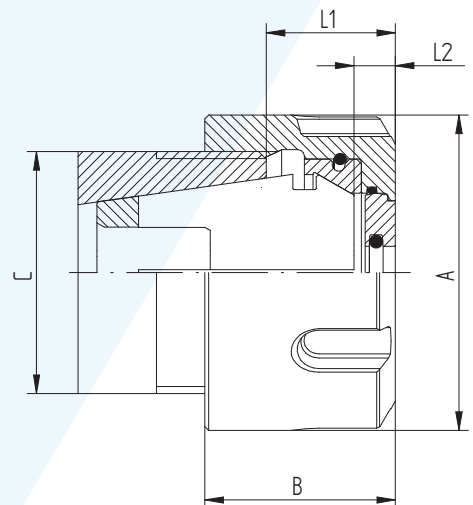

Hi-Q®/ERBC 25 – ERBC 40

Type	Part no.	Dimensions [mm]					C	Accessory
		A	B	L1	L2	SW		Wrench
Hi-Q®/ERB 16								
Hi-Q®/ERB 16	3416.30000	28	20.2	10.0–13.6	3	25	M 22 x 1.5	E 16 P
Hi-Q®/ERB 20								
Hi-Q®/ERB 20	3420.30000	34	21.7	11.0–14.5	3	30	M 25 x 1.5	E 20 P
Hi-Q®/ERB 25								
Hi-Q®/ERB 25	3425.30000	42	22.6	11.5–15.0	3	–	M 32 x 1.5	E 25
Hi-Q®/ERB 32								
Hi-Q®/ERB 32	3432.30000	50	25	12.5–16.0	3	–	M 40 x 1.5	E 32
Hi-Q®/ERB 40								
Hi-Q®/ERB 40	3440.30000	63	28.2	14.5–18.0	3	–	M 50 x 1.5	E 40
Hi-Q®/ERB 50								
Hi-Q®/ERB 50	3450.30000	78	38.1	17.0–24.0	3	–	M 64 x 2	E 50

Type	Part no.	Dimensions [mm]					C	Accessory
		A	B	L1	L2	SW		Wrench
Hi-Q®/ERBC 16								
Hi-Q®/ERBC 16	3416.40000	28	22.7	12.5–16.0	5.5	25	M 22 x 1.5	E 16 P
Hi-Q®/ERBC 20								
Hi-Q®/ERBC 20	3420.40000	34	24.2	13.5–17.0	5.5	30	M 25 x 1.5	E 20 P
Hi-Q®/ERBC 25								
Hi-Q®/ERBC 25	3425.40000	42	25.2	14.0–17.5	5.5	–	M 32 x 1.5	E 25
Hi-Q®/ERBC 32								
Hi-Q®/ERBC 32	3432.40000	50	27.4	15.0–18.5	5.5	–	M 40 x 1.5	E 32
Hi-Q®/ERBC 40								
Hi-Q®/ERBC 40	3440.40000	63	30.7	17.0–20.5	5.5	–	M 50 x 1.5	E 40

Hi-Q®/ERM minimal external diameter Hi-Q®/ERMC for coolant through tools

Application The mini clamping nut Hi-Q®/ERM is recommended for use where minimal external diameters are essential (e.g., machining space is very limited). Thus, it is ideally suitable for multispindle drilling heads and toolholder extensions. The corresponding wrenches have the same external dimensions as the clamping nuts.

Application with sealing disk/coolant flush disk The Hi-Q®/ERMC clamping nut is intended for use with the sealing disk system DS/ER and the coolant flush system KS/ER. The disk system allows the use of all standard ER collets, ultraprecision collets and tapping collets for coolant through tools.

- // Up to 150 bar / 2100 PSI coolant pressure
- // Prevents dirt and chips from entering the collet

For peripheral cooling of non coolant through tools we recommend the coolant flush disks KS/ER. Please refer to page 252. Accessories are not included in delivery.

Hi-Q®/ERMC 11 This clamping nut is recommended for use where minimal external diameters are important. It is the coolant through tools version of the Hi-Q®/ERM 11 clamping nut.

Hi-Q®/ERMC 11 does not require sealing disks The sealing system is built into the clamping nut.

- // Up to 150 bar / 2100 PSI coolant pressure
- // Prevents dirt and chips from entering the collet
- // Not interchangeable with nuts according to DIN 6499 / ISO 15488

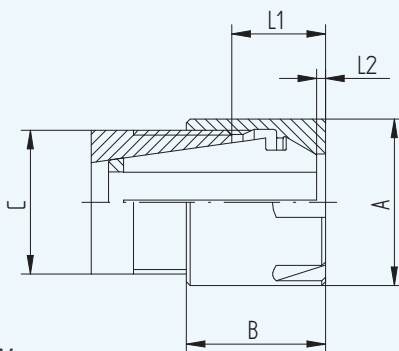
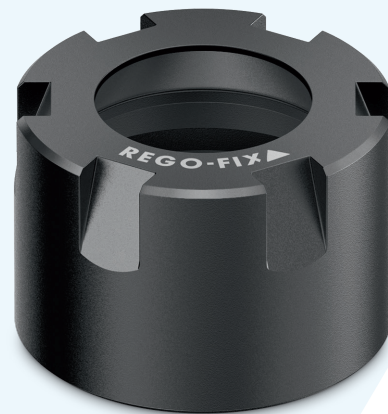

Hi-Q®/ERM

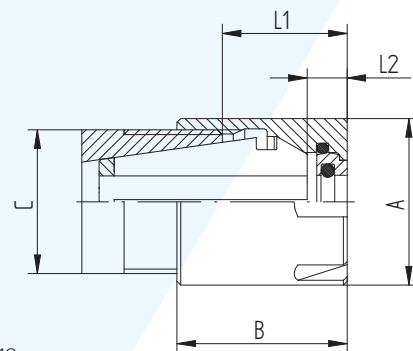

Hi-Q®/ERMC

Hi-Q®/ERM Hi-Q®/ERMC

ERM

ERMC

Type	Part no.	Dimensions [mm]					C	Bore Ø		Accessory Wrench
		A	B	L1	L2	[inch]		[mm]		
Hi-Q®/ERM 8										
Hi-Q®/ERM 8	3508.00000	12	10.8	4.3–6.1	1.5	M 10 x 0.75	–	–	E 8 M	
Hi-Q®/ERM 8 L	3508.02000	12	10.8	4.3–6.1	1.5	M 10 x 0.75-LH	–	–	E 8 M	
Hi-Q®/ERM 11										
Hi-Q®/ERM 11	3511.00000	16	12	5.7–7.5	0.4	M 13 x 0.75	–	–	E 11 M	
Hi-Q®/ERM 11 L	3511.02000	16	12	5.7–7.5	0.4	M 13 x 0.75-LH	–	–	E 11 M	
Hi-Q®/ERM 16										
Hi-Q®/ERM 16	3516.00000	22	18.4	8.0–11.5	0.9	M 19 x 1	–	–	E 16 M	
Hi-Q®/ERM 16 L	3516.02000	22	18.4	8.0–11.5	0.9	M 19 x 1-LH	–	–	E 16 M	
Hi-Q®/ERM 20										
Hi-Q®/ERM 20	3520.00000	28	19	8.0–11.5	–	M 24 x 1	–	–	E 20 M	
Hi-Q®/ERM 20 L	3520.02000	28	19	8.0–11.5	–	M 24 x 1-LH	–	–	E 20 M	
Hi-Q®/ERM 25										
Hi-Q®/ERM 25	3525.00000	35	20	8.5–12.0	–	M 30 x 1	–	–	E 25 M	
Hi-Q®/ERM 25 L	3525.02000	35	20	8.5–12.0	–	M 30 x 1-LH	–	–	E 25 M	

L = left-threaded nuts

Type	Part no.	Dimensions [mm]					C	Bore Ø		Accessory Wrench
		A	B	L1	L2	[mm]		[inch]		
Hi-Q®/ERMC 11										
Hi-Q®/ERMC 11, Ø 3.0 mm	3511.20300	16	14.6	8.1–9.8	3.5	M 13 x 0.75	3.0–2.5	3/32"	E 11 M	
Hi-Q®/ERMC 11, Ø 3.5 mm	3511.20350	16	14.6	8.1–9.8	3.5	M 13 x 0.75	3.5–3.0	1/8"	E 11 M	
Hi-Q®/ERMC 11, Ø 4.0 mm	3511.20400	16	14.6	8.1–9.8	3.5	M 13 x 0.75	4.0–3.5	5/32"	E 11 M	
Hi-Q®/ERMC 11, Ø 4.5 mm	3511.20450	16	14.6	8.1–9.8	3.5	M 13 x 0.75	4.5–4.0	–	E 11 M	
Hi-Q®/ERMC 11, Ø 5.0 mm	3511.20500	16	14.6	8.1–9.8	3.5	M 13 x 0.75	5.0–4.5	3/16"	E 11 M	
Hi-Q®/ERMC 11, Ø 5.5 mm	3511.20550	16	14.6	8.1–9.8	3.5	M 13 x 0.75	5.5–5.0	7/32"	E 11 M	
Hi-Q®/ERMC 11, Ø 6.0 mm	3511.20600	16	14.6	8.1–9.8	3.5	M 13 x 0.75	6.0–5.5	–	E 11 M	
Hi-Q®/ERMC 11, Ø 6.5 mm	3511.20650	16	14.6	8.1–9.8	3.5	M 13 x 0.75	6.5–6.0	1/4"	E 11 M	
Hi-Q®/ERMC 11, Ø 7.0 mm	3511.20700	16	14.6	8.1–9.8	3.5	M 13 x 0.75	7.0–6.5	–	E 11 M	
Hi-Q®/ERMC 16										
Hi-Q®/ERMC 16	3516.20000	22	22	11.5–15.0	4.5	M 19 x 1	–	–	E 16 M	
Hi-Q®/ERMC 20										
Hi-Q®/ERMC 20	3520.20000	28	24	13–16.5	5	M 24 x 1	–	–	E 20 M	
Hi-Q®/ERMC 25										
Hi-Q®/ERMC 25	3525.20000	35	25	13.5–17.0	5	M 30 x 1	–	–	E 25 M	

Hi-Q®/ERMX und Hi-Q®/ERMXC intRlox® Slip-off proof mini clamping nuts

Application For REGO-FIX ER toolholders with mini thread and cylindrical holders.

Key advantages

- // Design is ideally suited for lathes and Swiss turning machines
- // Very slim sizing proofs suitable for machines where space is limited
- // Safe handling thanks to the patented intRlox® profile
- // Slip-off proof design with all advantages of the regular mini clamping nuts
- // Easy and safe clamping with the MX wrench

Application with sealing disk/coolant flush disk The Hi-Q®/ERMXC clamping nut is intended for use with the sealing disk system DS/ER and the coolant flush system KS/ER. The disk system allows the use of all standard ER collets, ultraprecision collets and tapping collets for coolant through tools.

- // Up to 150 bar / 2100 PSI coolant pressure
- // Prevents dirt and chips from entering the collet

For peripheral cooling of non coolant through tools we recommend the coolant flush disks KS/ER. Please refer to page 252. Accessories are not included in delivery.

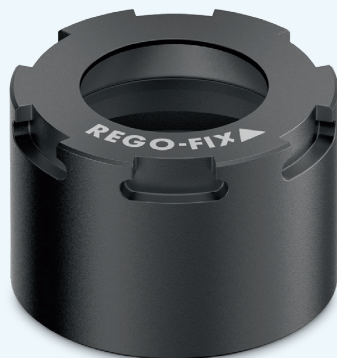

Hi-Q®/ERMX

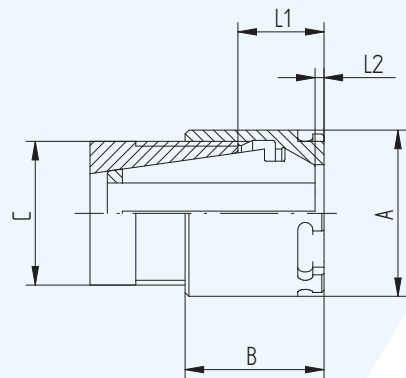

Hi-Q®/ERMX



Hi-Q®/ERMXC

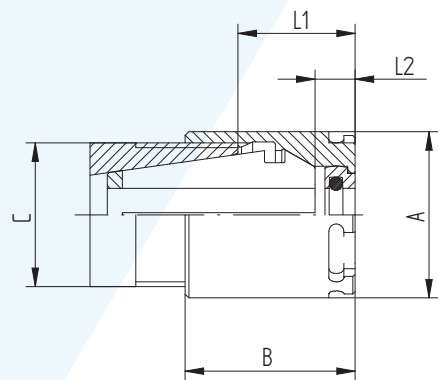

Hi-Q®/ERMXC

Hi-Q®/ERMX intRlox® Hi-Q®/ERMXC intRlox®

ERMX

ERMXC

Type	Part no.	Dimensions [mm]					C	Accessory
		A	B	L1	L2	Wrench		
Hi-Q®/ERMX 8								
Hi-Q®/ERMX 8	3508.60000	12	11	4.3–6.1	0.4	M 10 x 0.75	E 8 MX	
Hi-Q®/ERMX 11								
Hi-Q®/ERMX 11	3511.60000	16	12	5.7–7.5	0.4	M 13 x 0.75	E 11 MX	
Hi-Q®/ERMX 16								
Hi-Q®/ERMX 16	3516.60000	22	18.4	8.0–11.5	0.9	M 19 x 1	E 16 MX	
Hi-Q®/ERMX 20								
Hi-Q®/ERMX 20	3520.60000	28	19	8.0–11.5	0.0	M 24 x 1	E 20 MX	
Hi-Q®/ERMX 25								
Hi-Q®/ERMX 25	3525.60000	35	20	8.5–12.0	0.0	M 30 x 1	E 25 MX	

Type	Part no.	Dimensions [mm]					C	Accessory
		A	B	L1	L2	Wrench		
Hi-Q®/ERMXC 11								
Hi-Q®/ERMXC 11	3511.70000	16	14.6	7.5–9.3	3.5	M 13 x 0.75	E 11 MX	
Hi-Q®/ERMXC 16								
Hi-Q®/ERMXC 16	3516.70000	22	22.5	11.5–15.0	4.5	M 19 x 1	E 16 MX	
Hi-Q®/ERMXC 20								
Hi-Q®/ERMXC 20	3520.70000	28	24	13.0–16.5	5	M 24 x 1	E 20 MX	
Hi-Q®/ERMXC 25								
Hi-Q®/ERMXC 25	3525.70000	35	25	13.0–17.0	5	M 30 x 1	E 25 MX	

ER MS clamping nuts for highest RPM

Application The ER MS clamping nut for highest RPM with minimal external diameter does not have the collet-locking system and all the contours are ground. This provides best balancing for critical high-speed machining applications.

The collet is released with the corresponding E MS wrench. ER MS nuts are also interchangeable with the Hi-Q®/ERM and Hi-Q®/ERMC nuts. With the ER MS clamping nuts we recommend using ER-UP (ultra-precision) collets to achieve the highest runout TIR.

Key advantages

- // Precision-machined contours on all sides
- // Minimal residual unbalance
- // For high rpm up to 80,000

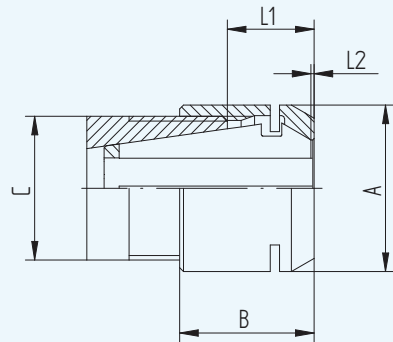
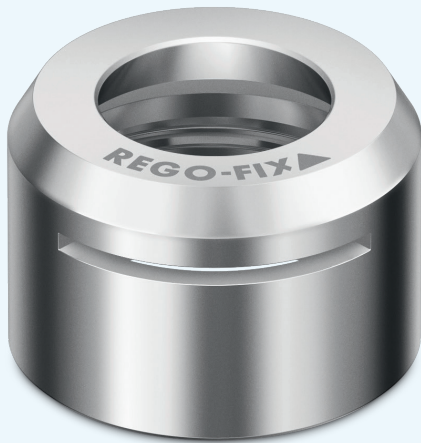

ER MS

Type	Part no.	Dimensions [mm]				C	Accessory
		A	B	L1	L2		Wrench
ER 8 MS							
ER 8 MS	3208.50000	12	10.8	4.3–6.1	1.5	M 10 x 0.75	E 8 MS
ER 11 MS							
ER 11 MS	3211.50000	16	11.5	4.6–6.8	0.4	M 13 x 0.75	E 11 MS
ER 16 MS							
ER 16 MS	3216.50000	22	17.8	6.1–10.5	0.3	M 19 x 1	E 16 MS
ER 20 MS							
ER 20 MS	3220.50000	28	19	7.1–11.5	0.6	M 24 x 1	E 20 MS

Hi-Q®/ERAX with external thread Hi-Q®/ERAXC for coolant through tools

Application For REGO-FIX floating chucks and other ER toolholders with internal thread, e.g., ERA holders. These nuts can also be used on driven tools with internal threads.
*Please refer to page 77 for the SK/ERA Zero-Z® toolholder.
Please refer to page 81 for BT/ERA Zero-Z® toolholder.*

Key advantages

- // Space-saving design for ideal use on long-turning machines
- // S-profile wrench is self-centering on the nut and prevents slipping off while tightening the nut

Application with sealing disk/coolant flush disk The Hi-Q®/ERAXC clamping nut is intended for use with the sealing disk system DS/ER and the coolant flush system KS/ER. The disk system allows the use of all standard ER collets, ultraprecision collets and tapping collets for coolant through tools.

- // Up to 150 bar / 2100 PSI coolant pressure
- // Prevents dirt and chips from entering the collet

For peripheral cooling of non coolant through tools we recommend the coolant flush disks KS/ER. Please refer to page 252.

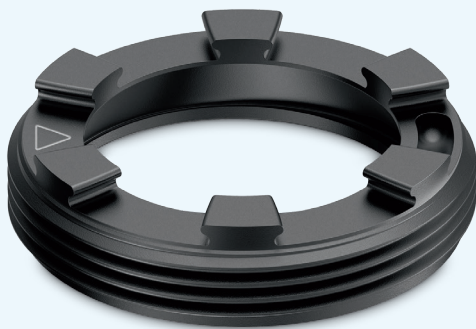

Hi-Q®/ERAX

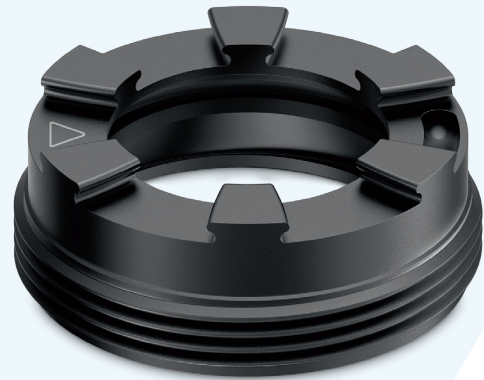

Hi-Q®/ERAXC

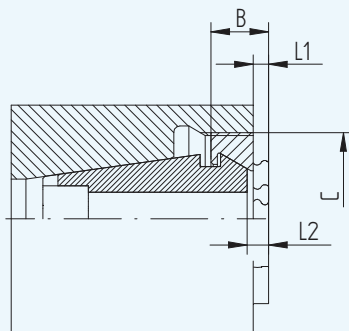

Hi-Q®/ERAX

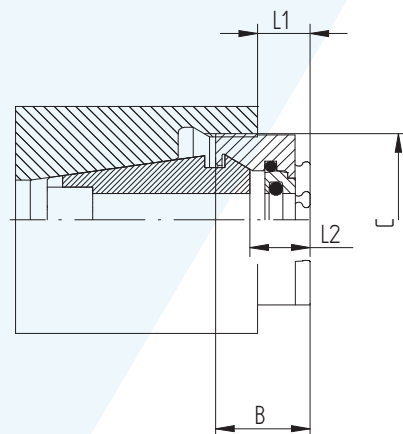

Hi-Q®/ERAXC

Hi-Q®/ERAX

Hi-Q®/ERAXC

ERAX

ERAXC

Type	Part no.	Dimensions [mm]			C	Accessory
		B	L1	L2		Wrench
Hi-Q®/ERAX 11						
Hi-Q®/ERAX 11	3311.60000	7.5	1.0–3.2	3.9	M 18 x 1	E 11 AX
Hi-Q®/ERAX 16						
Hi-Q®/ERAX 16	3316.60000	7.6	0–2.6	2.3	M 24 x 1	E 16 AX
Hi-Q®/ERAX 20						
Hi-Q®/ERAX 20	3320.60000	8.5	0–2.5	2.3	M 28 x 1.5	E 20 AX
Hi-Q®/ERAX 25						
Hi-Q®/ERAX 25	3325.60000	8.8	0–1.9	2.3	M 32 x 1.5	E 25 AX
Hi-Q®/ERAX 32						
Hi-Q®/ERAX 32	3332.60000	9.8	0–1.1	2.5	M 40 x 1.5	E 32 AX
Hi-Q®/ERAX 40						
Hi-Q®/ERAX 40	3340.60000	11.7	0–1.0	2.4	M 50 x 1.5	E 40 AX

Typ	Part no.	Dimensions [mm]			C	Accessory
		B	L1	L2		Wrench
Hi-Q®/ERAXC 11						
Hi-Q®/ERAXC 11	3311.70000	9.2	2.7–4.9	6.1	M 18 x 1	E 11 AX
Hi-Q®/ERAXC 16						
Hi-Q®/ERAXC 16	3316.70000	12.5	3.1–7.5	7.2	M 24 x 1	E 16 AX
Hi-Q®/ERAXC 20						
Hi-Q®/ERAXC 20	3320.70000	13.5	3.1–7.5	7.3	M 28 x 1.5	E 20 AX
Hi-Q®/ERAXC 25						
Hi-Q®/ERAXC 25	3325.70000	13.8	2.5–6.9	7.3	M 32 x 1.5	E 25 AX
Hi-Q®/ERAXC 32						
Hi-Q®/ERAXC 32	3332.70000	14.9	1.8–6.2	7.6	M 40 x 1.5	E 32 AX
Hi-Q®/ERAXC 40						
Hi-Q®/ERAXC 40	3340.70000	16.6	1.5–5.9	7.3	M 50 x 1.5	E 40 AX

Fast and easy retrofitting: From external flood cooling to internal cooling

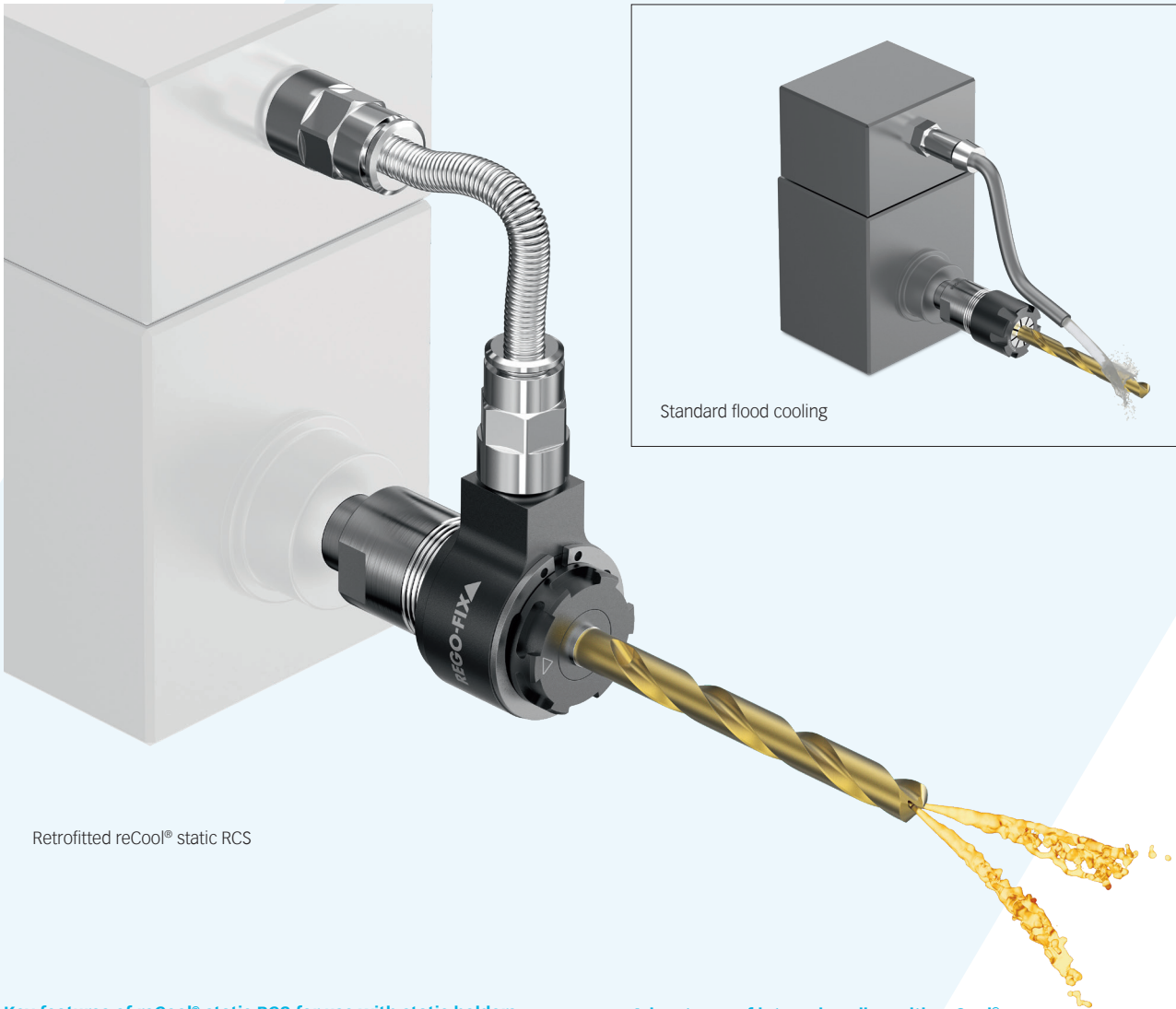

Retrofitted reCool® static RCS

Key features of reCool® static RCS for use with static holders

- // Cost-friendly conversion of existing static tooling systems to through coolant in only two minutes
- // For ER collets (DIN 6499/ISO 15488) in stationary toolholders with external fine threads
- // Coolant pressures of up to 150 bar / 2100 PSI*
- // RCS/ERMx for emulsion and oil coolants
- // Low-maintenance design
- // For coolant through tools (with sealing disks DS) and for peripheral cooling (with coolant flush disks KS)
- // Not for use with sealed collets DM

* With high-pressure hoses RHS-HP. 100 bar / 1400 PSI with standard hose
Accessories are not included in delivery.

Advantages of internal cooling with reCool®

- // Optimized coolant supply to the cutting edge: increases tool life and reduces cycletime
- // Best chip removal
- // No scattering or spray losses

Type	Part no.	Dimensions [mm]		Thread	Accessory	Included in set RCR	
		B	D		Wrench	Type	Qty.
Set RCS (for emulsion- and oil-based coolants)						RCS/ERMX 16/20	1
SET RCS/ERMX 16	3716.50000	22.5	27.5	M 19 x 1	E 16 MX	SET RHS-100	1
SET RCS/ERMX 20	3720.50000	24	34.5	M 24 x 1	E 20 MX	SET RVG-100 1/8" - 0°	2
RCS/ERMX nut (for emulsion- and oil-based coolants)						SET RVA-100 1/8" - 90°	2
RCS/ERMX 16	3716.59000	22.5	27.5	M 19 x 1	E 16 MX		
RCS/ERMX 20	3720.59000	24	34.5	M 24 x 1	E 20 MX		

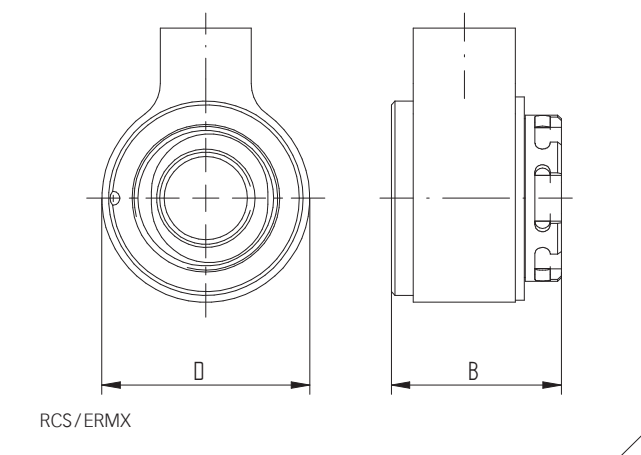
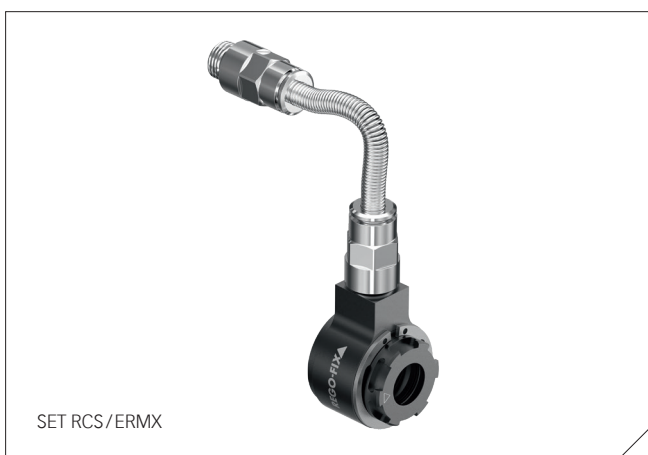

reCool® sets overview

reCool® RCS and reCool® RCR sets

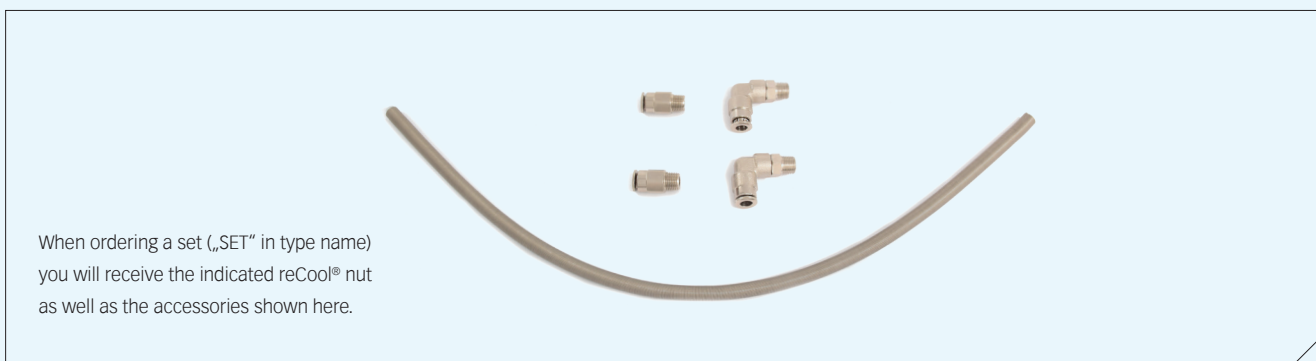

Low-cost retrofitting to internal cooling



Retrofitted with reCool® rotary RCR/ER, RCR/ERM

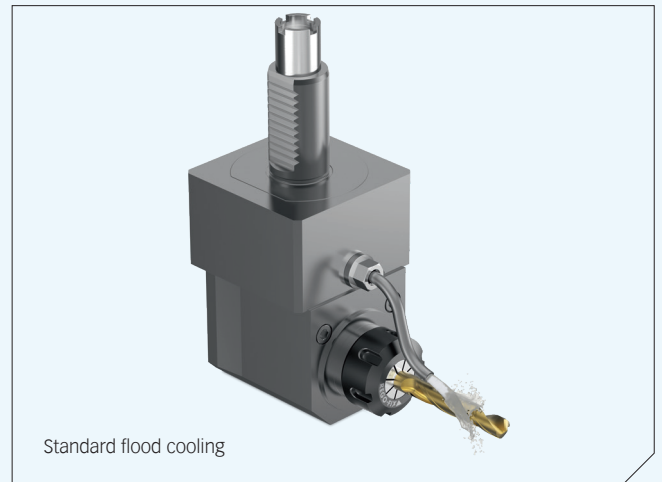

Key features of reCool® rotary RCR for use with spindles

- // Cost-friendly conversion of existing driven tooling systems to through coolant in only two minutes
- // For ER and ERM thread in driven tools and turning machines and for ER collets to DIN 6499 / ISO 15488
- // Speeds up to 12.000 rpm*
- // Coolant pressures up to 150 bar with high-pressure hose, standard hose max. 100 bar / 1400 PSI
- // Low-maintenance coolant lubricated bearings
- // For coolant through tools (with sealing disks DS / ER) and for peripheral cooling (with coolant flush disks KS / ER)
- // RCR / ER(M) for emulsion and oil coolants
- // Not for use with sealed collets DM

* 6.000 rpm with RCR / ER 40.
Accessories are not included in delivery.

Advantages of internal cooling with reCool®

- // Optimized coolant supply to the cutting edge: increases tool life and reduces cycle time
- // Best chip removal
- // No scattering or spray losses

Type	Part no.	Dimensions [mm]		Thread	Accessory	Included in set RCR/ER	
		B	D		Wrench	Type	Qty.
Set RCR/ER (for emulsion- and oil-based coolants)							
SET RCR/ER 11	3711.10000	16.6	21.75	M 14 x 0.75	E 11 AX	RCR/ER 11-40	1
SET RCR/ER 16	3716.10000	24.5	34	M 22 x 1.5	E 16 AX	SET RHS-100	1
SET RCR/ER 20	3720.10000	26	40	M 25 x 1.5	E 20 AX	SET RVG-100 1/8"-0°	2
SET RCR/ER 25	3725.10000	27	50	M 32 x 1.5	E 25 AX	SET RVA-100 1/8"-90°	2
SET RCR/ER 32	3732.10000	29.5	62.5	M 40 x 1.5	E 32 AX		
SET RCR/ER 40	3740.10000	32.5	72.5	M 50 x 1.5	E 40 AX		

Type	Part no.	Dimensions [mm]		Thread	Accessory
		B	D		Wrench
RCR/ER nut (for emulsion- and oil-based coolants)					
RCR/ER 11	3711.19000	16.6	21.75	M 14 x 0.75	E 11 AX
RCR/ER 16	3716.19000	24.5	34	M 22 x 1.5	E 16 AX
RCR/ER 20	3720.19000	26	40	M 25 x 1.5	E 20 AX
RCR/ER 25	3725.19000	27	50	M 32 x 1.5	E 25 AX
RCR/ER 32	3732.19000	29.5	62.5	M 40 x 1.5	E 32 AX
RCR/ER 40	3740.19000	32.5	72.5	M 50 x 1.5	E 40 AX

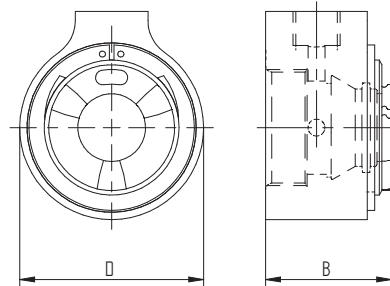

RCR/ER, RCR/ERM

Type	Part no.	Dimensions [mm]		Thread	Accessory	Included in set RCR/ERM	
		B	D		Wrench	Type	Qty.
Set RCR/ERM (for emulsion- and oil-based coolants)							
SET RCR/ERM 11	3711.30000	16.6	21.75	M 13 x 0.75	E 11 AX	RCR/ERM 11-25	1
SET RCR/ERM 16	3716.30000	24.5	31	M 19 x 1	E 16 AX	SET RHS-100	1
SET RCR/ERM 20	3720.30000	26	38	M 24 x 1	E 20 AX	SET RVG-100 1/8"-0°	2
SET RCR/ERM 25	3725.30000	27	46	M 30 x 1	E 25 AX	SET RVA-100 1/8"-90°	2

Type	Part no.	Dimensions [mm]		Thread	Accessory
		B	D		Wrench
RCR/ERM nut (for emulsion- and oil-based coolants)					
RCR/ERM 11	3711.39000	16.6	21.75	M 13 x 0.75	E 11 AX
RCR/ERM 16	3716.39000	24.5	31	M 19 x 1	E 16 AX
RCR/ERM 20	3720.39000	26	38	M 24 x 1	E 20 AX
RCR/ERM 25	3725.39000	27	46	M 30 x 1	E 25 AX

Matching accessories for your reCool®

Type	Part no.	Dimensions [mm]		Thread G1	Thread G2	Accessory
		d	L			Wrench
reCool® adapter						
RC-ADP 16	3799.81600	16	8.7	M 24 x 1	M 22 x 1.5	E 16 P
RC-ADP 20	3799.82000	20	8.2	M 28 x 1.5	M 25 x 1.5	E 20 P
RC-ADP 25	3799.82500	25	7.9	M 32 x 1.5	M 32 x 1.5	E 25
RC-ADP 32	3799.83200	32	8.7	M 40 x 1.5	M 40 x 1.5	E 32
RC-ADP 40	3799.84000	40	9.6	M 50 x 1.5	M 50 x 1.5	E 40

reCool® adapter The reCool® adapter RC-ADP easily converts inner-threaded driven tools to outer-threaded ones which enables the use of the reCool® rotary coolant supply system RCR with different types of driven tooling.

How to use? Just screw the adapter with advised tightening torque into the driven tool, use the correctly installed reCool® rotary coolant supply system RCR and clamp the tool.

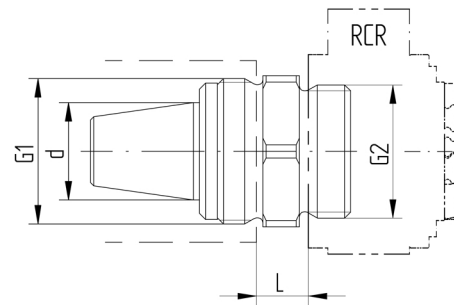

RC-ADP

Expert advice

reCool® is only applicable with the use of our sealing DS/ER and Coolant flush disks KS/ER. Please note, that neither DS/ER nor KS/ER are included in the reCool® sets.

Please refer to page 244 for sealing disks and to page 252 for coolant flush disks.

Type	Part no.	Length [mm]
High-pressure hoses (≤150 bar) with threaded 1/8" ends		
SET RHS-HP L100	3799.97100	100
SET RHS-HP L200	3799.97200	200
SET RHS-HP L300	3799.97300	300
SET RHS-HP L400	3799.97400	400
SET RHS-HP L500	3799.97500	500
SET RHS-HP L600	3799.97600	600
SET RHS-HP L700	3799.97700	700

Standard hose set (≤100 bar) incl. steel spiral		
SET RHS-100	3799.95000	400*

*The length can be shortened individually between 50 - 400 mm

Fitting sets (2 pieces each)		
SET RVG-100 1/8" -0°	3799.96180	-
SET RVA-100 1/8" -90°	3799.96189	-
SET RVG-100 M8 x 1 -0°	3799.96810	-

Thread adapter		
RGA 1/8" BSP - 1/8" NPT	3799.98180	-

Type	Part no.	Ø [mm]	Length [mm]
Ball adapters RBA (1/8" BSP)			
RBA 10	3799.93100	10	-
RBA 11	3799.93110	11	-
RBA 12	3799.93120	12	-
RBA 13	3799.93130	13	-
RBA 14	3799.93140	14	-
RBA 15	3799.93150	15	-
RBA 16	3799.93160	16	-

Aluminum ring adapters RRA (1/8" BSP)			
RRA 10	3799.94100	10	-
RRA 11	3799.94110	11	-
RRA 12	3799.94120	12	-
RRA 13	3799.94130	13	-
RRA 14	3799.94140	14	-
RRA 15	3799.94150	15	-
RRA 16	3799.94160	16	-

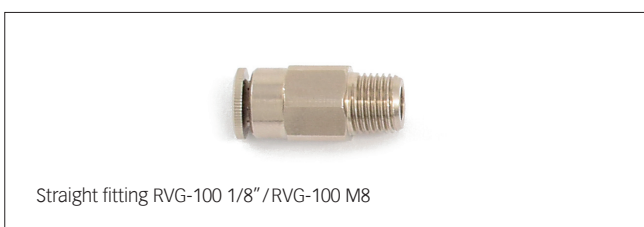
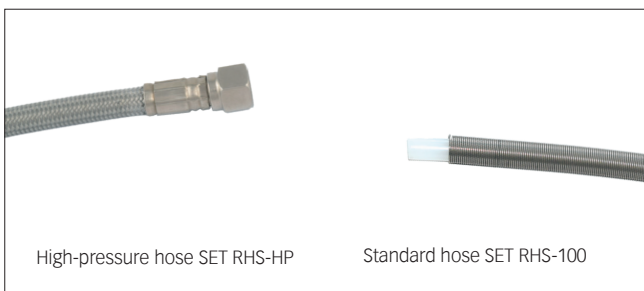

Expert advice

The ball adapter **RBA** is used when the driven tool has a ball connection. The fitting can then be used on the hose.

The aluminum ring adapter **RRA** can be used when the driven tool cooling connection uses the "press-in" principle.



Use conditions RCR reCool®

reCool® is used exclusively for clamping tools with ER collets (DIN 6499 / ISO 15488). Only original collets, sealing and cooling disks REGO-FIX® are recommended to be used.

Technical data

The following parameters apply to reCool® rotation:

Max. Rotation speed:	12,000 rpm (6000 rpm with ER40)
Max. coolant pressure:	150 bar / 2175 PSI* (with high pressure hose)
Min. coolant pressure:	depending on the rotational speed (see table)

	≤ 3,000 min ⁻¹	≤ 6,000 min ⁻¹	≤ 9,000 min ⁻¹	≤ 12,000 min ⁻¹
RCR/ER 11	5 bar / 73 PSI	7.5 bar / 109 PSI	10 bar / 145 PSI	15 bar / 218 PSI
RCR/ER 16	5 bar / 73 PSI	7.5 bar / 109 PSI	10 bar / 145 PSI	15 bar / 218 PSI
RCR/ER 20	5 bar / 73 PSI	7.5 bar / 109 PSI	10 bar / 145 PSI	15 bar / 218 PSI
RCR/ER 25	5 bar / 73 PSI	7.5 bar / 109 PSI	10 bar / 145 PSI	15 bar / 218 PSI
RCR/ER 32	5 bar / 73 PSI	7.5 bar / 109 PSI	10 bar / 145 PSI	15 bar / 218 PSI
RCR/ER 40	5 bar / 73 PSI	7.5 bar / 109 PSI	–	–
RCR/ERM 11	5 bar / 73 PSI	7.5 bar / 109 PSI	10 bar / 145 PSI	15 bar / 218 PSI
RCR/ERM 16	5 bar / 73 PSI	7.5 bar / 109 PSI	10 bar / 145 PSI	15 bar / 218 PSI
RCR/ERM 20	5 bar / 73 PSI	7.5 bar / 109 PSI	10 bar / 145 PSI	15 bar / 218 PSI
RCR/ERM 25	5 bar / 73 PSI	7.5 bar / 109 PSI	10 bar / 145 PSI	15 bar / 218 PSI

Cooling medium: Emulsion or oil up to viscosity ≤ ISO VG 46 (46 mm²/s 40°C) and filtered 20 μm

Working temperature: 10° C to 60° C

***The supplied hose and fittings are designed and tested for maximum coolant pressure of 100 bar / 1450 PSI. For higher coolant pressures the High-pressure hose is mandatory.**

Dimensions

Type	Clamping range [mm]	D [mm]	L [mm]	H [mm]	G
RCR/ER 11	3.00 – 6.00	21.75	29.50	16.50	M14 x 0.75
RCR/ER 16	3.00 – 10.00	34.00	39.50	24.50	M22 x 1.5
RCR/ER 20	3.00 – 13.00	40.00	44.50	26.00	M25 x 1.5
RCR/ER 25	3.00 – 16.00	50.00	53.50	27.00	M32 x 1.5
RCR/ER 32	3.00 – 20.00	62.50	64.75	29.50	M40 x 1.5
RCR/ER 40	3.00 – 26.00	72.50	74.75	32.50	M50 x 1.5
RCR/ERM 11	3.00 – 6.00	21.75	29.50	16.50	M13 x 0.75
RCR/ERM 16	3.00 – 10.00	31.00	36.50	24.50	M19 x 1
RCR/ERM 20	3.00 – 13.00	38.00	43.00	26.00	M24 x 1
RCR/ERM 25	3.00 – 17.00	46.00	50.50	27.00	M30 x 1

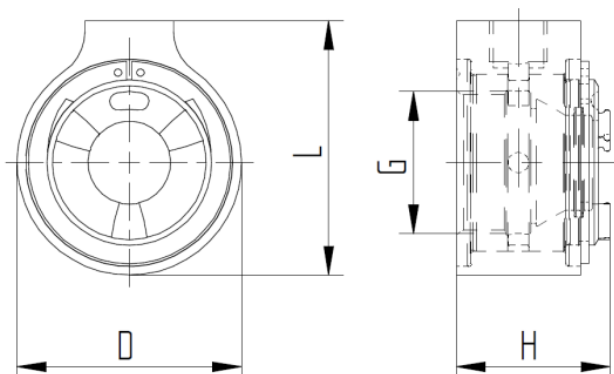

Cleaning instructions

reCool® is designed with a wear resistant coating, eliminating the need for extensive maintenance. The only time cleaning is needed is when the RCR system no longer rotates lightly by hand.



Mark the position of the inner part to outer ring.



Remove the retaining ring with pliers.

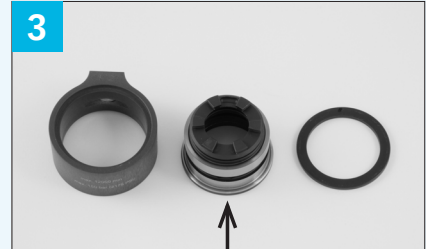

Now slide out inner part.



Remove the disk.



Clean all parts intensively with a standard industrial cleaning agent.

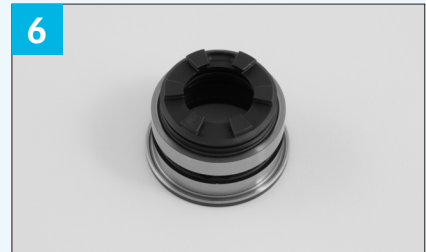

Lightly oil the bearing surfaces with thin lubricating oil.



Put the parts in the correct position together.



Mount this retaining ring.



Pay attention that it snaps into place.

! reCool® parts may not be swapped out. Original configuration must be maintained.

! Never let the reCool® system run dry.

! When starting the machine, make sure that coolant flows out of the tool or the coolant flush disk before rotating the reCool® System.

! A coolant pressure below minimum may lead to inadequate cooling/lubrication and therefore could damage the reCool® bearings.

! Inadequate coolant pressure results in considerable impairment in cooling the tool and chip removal.

! Stop screws with coolant through bores must be replaced!



! If the stop screw is not sealed nor replaced, there is danger that the coolant may get inside the gears which may result in damages of the driven tool.

! For best cooling do not exploit the clamping range of the collet. E.g. clamp a Ø 6mm tool shank in Ø 6.0 – 5.0 mm collet.

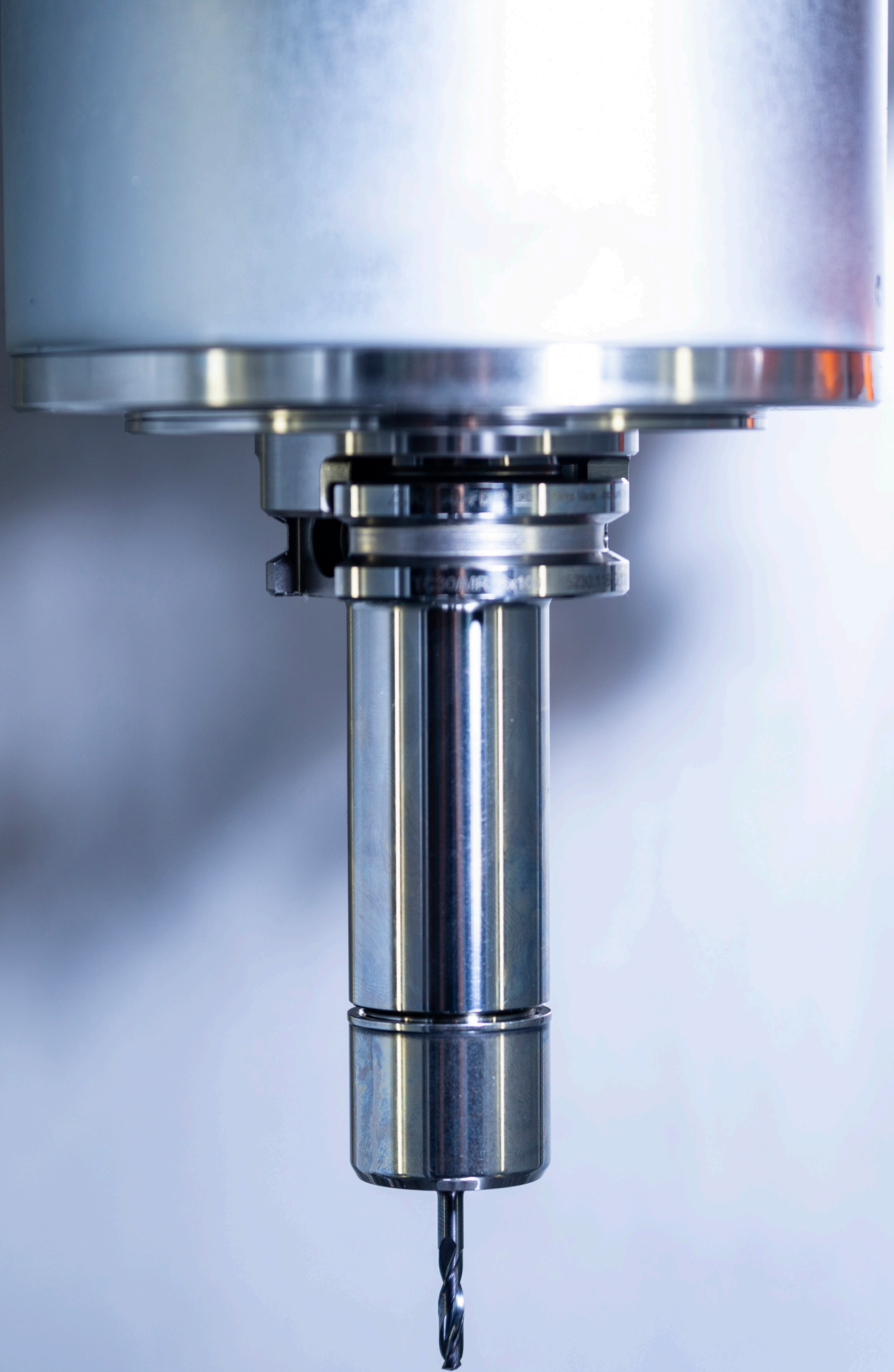



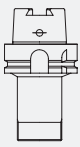
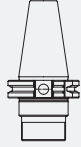
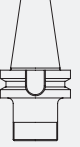
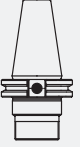

! Do not use metallic sealed ER-DM collets with reCool, because the coolant cannot reach the tool.







Experience high-precision toolholding

Standard				Cylindrical colletholders
HSK/MR HSK/MRM	SK/ MR	BT/ MR	CAT/ MR	CYL/MR CYL/MRM
				
page 185	page 190	page 192	page 194	page 196

Collets
MR

page 199

Standard		Mini nut	Sealing and coolant flush disks		
MR	MRC	MRM	MRMC	DS/MR	KS/MR
					
page 204	page 204	page 204	page 204	page 244	page 252

Standard				Cylindrical collets
HSK/MR HSK/MRM	SK/ MR	BT/ MR	CAT/ MR	CYL/MR CYL/MRM
				
page 185	page 190	page 192	page 194	page 196



Toolholders in Swiss quality



	HSK/MR	BT/MR	SK/MR	CAT/MR	CYL/MR	CYL/MRM
Norm	DIN 69893 ISO 12164	MAS 403 JIS B 6339 DIN-ISO 7388-2	DIN 69871 DIN ISO 7388-1	DIN 6871 DIN ISO 7388-1	–	–
Balancing	G 2.5 @ 25,000 min ⁻¹	G 2.5 @ 25,000 min ⁻¹	G 2.5 @ 25,000 min ⁻¹	G 2.5 @ 25,000 min ⁻¹	–	–
Chip hole	•	–	•	–	–	–
Runout TIR	≤0.003 mm	≤0.003 mm	≤0.003 mm	≤0.003 mm	≤0.003 mm	≤0.003 mm
Taper accuracy	DIN ISO	AT3	AT3	AT3	–	–
Form A + AD	–	•	•	–	–	–
Form AD + B	–	•	•	–	–	–
Shank tolerance	–	–	–	–	h6	h6

HSK toolholders

Designed for rotating applications, all our HSK toolholders are suited for high-speed applications where a consistent performance is key.

DIN 69893 / ISO 12164

Features and benefits

Total system runout TIR $\leq 3\mu\text{m}$ @ 3xD

Our holistic system consists of an micRun® toolholder, collet and clamping nut. All components together ensure best runout and accuracy.

Toolholder runout TIR $\leq 1\mu\text{m}$

Measured from inner taper to outer taper.

Surface finish max. Ra 0.25

Achieve high clamping force and high transferable torque.

Balancing

100% balanced to G 2.5 @ 25,000 rpm / <1gmm.

MR clamping nut included in delivery

Guarantees highest clamping force and best balancing.

Vibration dampening

Our holders offer good vibration dampening to sustain a high surface finish and can help prevent chatter.

Accessories are not included in delivery

Expert advice

For all HSK-A and HSK-E form toolholders a range of coolant tubes (KSR) is available.

For KSR part numbers please refer to page 265.

Balancing specifications

HSK 25	balanced to 90,000 min ⁻¹
HSK 32	balanced to 60,000 min ⁻¹
HSK 40	balanced to 45,000 min ⁻¹
HSK 50	balanced to 36,000 min ⁻¹
HSK 63	G 2.5 @ 25,000 min ⁻¹
HSK 80	G 2.5 @ 25,000 min ⁻¹
HSK 100	G 2.5 @ 25,000 min ⁻¹
HSK 125	G 2.5 @ 25,000 min ⁻¹

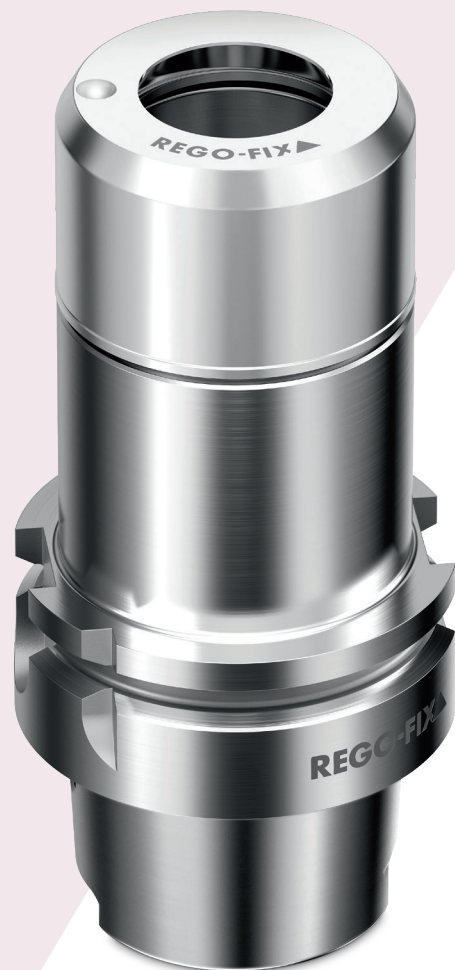

HSK-A toolholders

HSK-A

DIN 69893

ISO 12164

Type	Part no.	Dimensions [mm]		Accessory
		D	L	Freewheel wrench head
HSK-A 32				
HSK-A 32/MRM 16 x 060	5532.11620	24	60	A-FLS Ø 24/MRM 16
HSK-A 32/MRM 16 x 100	5532.11650	24	100	A-FLS Ø 24/MRM 16
HSK-A 40				
HSK-A 40/MR 16 x 060	5540.11620	28	60	A-FLS Ø 28/MR 16
HSK-A 40/MR 16 x 100	5540.11650	28	100	A-FLS Ø 28/MR 16
HSK-A 40/MR 25 x 080	5540.12540	40	80	A-FLS Ø 40/MR 25
HSK-A 50				
HSK-A 50/MR 16 x 100	5550.11650	28	100	A-FLS Ø 28/MR 16
HSK-A 50/MR 25 x 080	5550.12540	40	80	A-FLS Ø 40/MR 25
HSK-A 63				
HSK-A 63/MR 11 x 100	5563.11150	16	100	A-FLS Ø 16/MR 11
HSK-A 63/MR 11 x 160	5563.11180	16	160	A-FLS Ø 16/MR 11
HSK-A 63/MR 16 x 100	5563.11650	28	100	A-FLS Ø 28/MR 16
HSK-A 63/MRM 16 x 100	5563.11657	24	100	A-FLS Ø 28/MR 16
HSK-A 63/MRM 16 x 160	5563.11687	24	160	A-FLS Ø 28/MR 16
HSK-A 63/MR 25 x 080	5563.12540	40	80	A-FLS Ø 40/MR 25
HSK-A 63/MR 25 x 160	5563.12580	40	160	A-FLS Ø 40/MR 25
HSK-A 63/MR 32 x 070	5563.13230	50	70	A-FLS Ø 50/MR 32
HSK-A 63/MR 32 x 100	5563.13250	50	100	A-FLS Ø 50/MR 32

Included in delivery: MR toolholders come with Hi-Q®/MR clamping nut
 HSK-A: Hole for data carrier DIN STD 69873 in the flange available on request

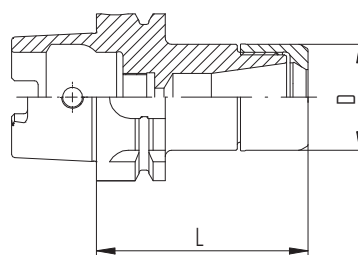

HSK-E toolholders

HSK-E

DIN 69893

ISO 12164

Type	Part no.	Dimensions [mm]		Accessory
		D	L	Freewheel wrench head
HSK-E 25				
HSK-E 25/MR 11 x 045	5525.11114	16	45	A-FLS Ø 16/MR 11
HSK-E 25/MRM 16 x 045	5525.11618	24	45	A-FLS Ø 24/MRM 16
HSK-E 32				
HSK-E 32/MR 11 x 060	5532.11124	16	60	A-FLS Ø 16/MR 11
HSK-E 32/MRM 16 x 055	5532.11618	24	55	A-FLS Ø 24/MRM 16
HSK-E 40				
HSK-E 40/MR 11 x 050	5540.11114	16	50	A-FLS Ø 16/MR 11
HSK-E 40/MR 11 x 100	5540.11154	16	100	A-FLS Ø 16/MR 11
HSK-E 40/MRM 16 x 055	5540.11618	24	55	A-FLS Ø 24/MRM 16
HSK-E 40/MRM 16 x 080	5540.11648	24	80	A-FLS Ø 24/MRM 16
HSK-E 40/MR 25 x 065	5540.12520	40	65	A-FLS Ø 40/MR 25
HSK-E 50				
HSK-E 50/MR 16 x 100	5550.11654	28	100	A-FLS Ø 28/MR 16
HSK-E 50/MR 25 x 070	5550.12534	40	70	A-FLS Ø 40/MR 25

Included in delivery: MR toolholders come with Hi-Q®/MR clamping nut

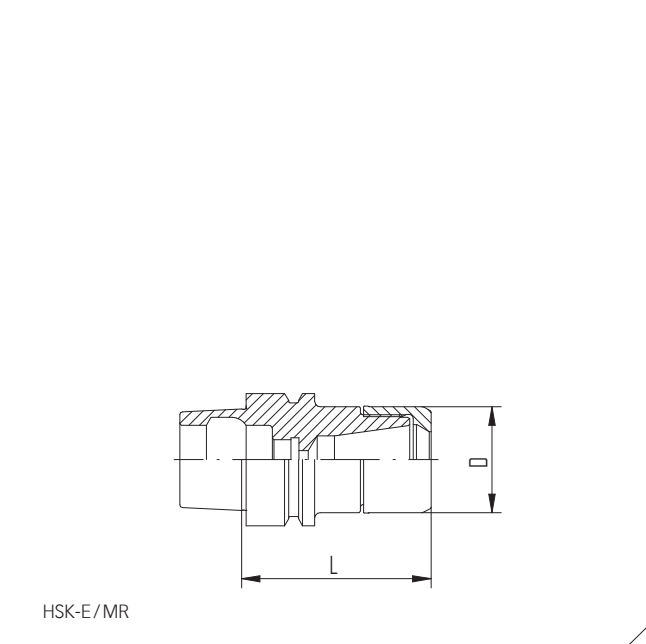



Steep taper toolholders SK

Universally suitable for different machining applications.

DIN 69871 / DIN ISO 7388-1

Features and benefits

Total system runout TIR $\leq 3\mu\text{m}$ @ 3xD

Our holistic system consists of an micRun® toolholder, collet and clamping nut. All components together ensure best runout and accuracy.

Toolholder runout TIR $\leq 1\mu\text{m}$

Measured from inner taper to outer taper.

Taper accuracy AT3

Better spindle-to-holder fit and accuracy.

Surface finish max. Ra 0.25

Achieve high clamping force and high transferable torque.

Balancing

100% balanced to G 2.5 @ 25,000 rpm / <1gmm.

MR clamping nut included in delivery

Guarantees highest clamping force and best balancing.

Vibration dampening

Our holders offer good vibration dampening to sustain a high surface finish and can help prevent chatter.

Accessories are not included in delivery

Balancing specifications

SK 30	balanced to 30,000 min ⁻¹
SK 40	G 2.5 @ 25,000 min ⁻¹
SK 50	G 2.5 @ 25,000 min ⁻¹

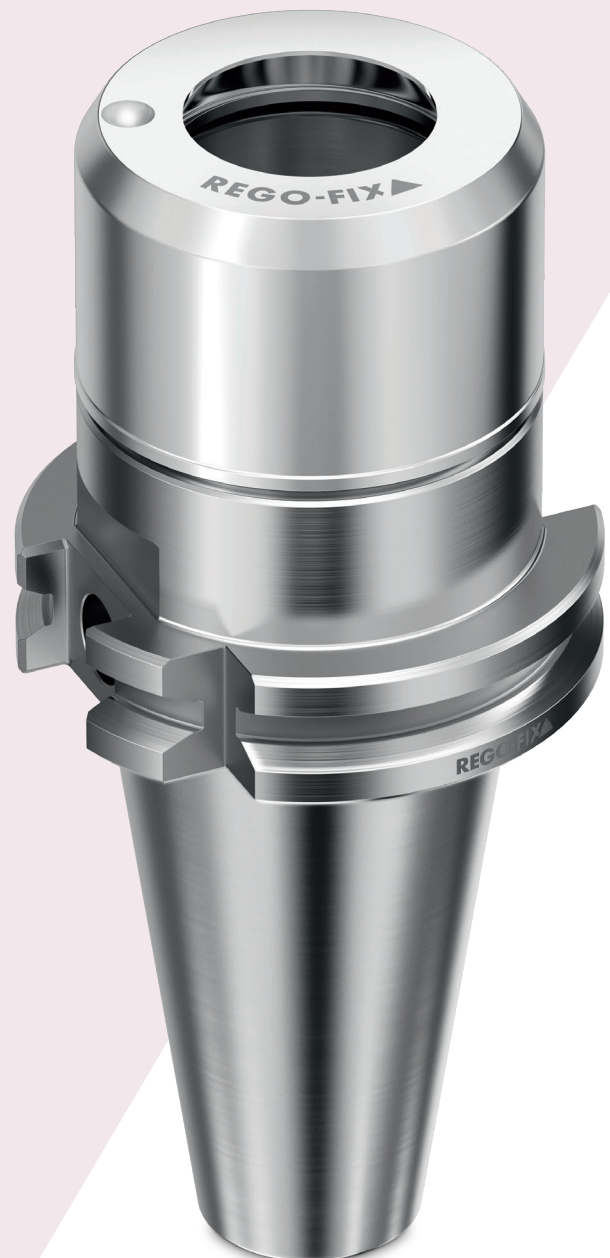

Type	Part no.	Dimensions [mm]		Accessory
		D	L	Freewheel wrench head
SK 30				
SK 30/MR 16 x 050	5230.11610	28	50	A-FLS Ø 28/MR 16
SK 30/MR 16 x 100	5230.11650	28	100	A-FLS Ø 28/MR 16
SK 30/MR 25 x 070	5230.12530	40	70	A-FLS Ø 40/MR 25
SK 40				
SK 40/MR 11 x 100	5240.11150	16	100	A-FLS Ø 16/MR 11
SK 40/MR 16 x 070	5240.11630	28	70	A-FLS Ø 28/MR 16
SK 40/MR 16 x 100	5240.11650	28	100	A-FLS Ø 28/MR 16
SK 40/MR 16 x 160	5240.11680	28	160	A-FLS Ø 28/MR 16
SK 40/MR 25 x 070	5240.12530	40	70	A-FLS Ø 40/MR 25
SK 40/MR 25 x 100	5240.12550	40	100	A-FLS Ø 40/MR 25
SK 40/MR 25 x 160	5240.12580	40	160	A-FLS Ø 40/MR 25
SK 40/MR 32 x 070	5240.13230	50	70	A-FLS Ø 50/MR 32
SK 40/MR 32 x 100	5240.13250	50	100	A-FLS Ø 50/MR 32
SK 40/MR 32 x 160	5240.13280	50	160	A-FLS Ø 50/MR 32

Included in delivery: MR toolholders come with Hi-Q®/MR clamping nut

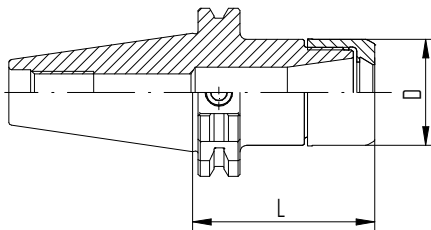

SK / MR (Form A+AD)

Expert advice

We recommend tightening the clamping nuts with our TORCO-BLOCK or torque wrench. Get the best accuracy by respecting the suitable tightening forces.

For recommended REGO-FIX accessories, please refer to page 262.

Steep taper toolholders BT

Universally suitable different machining applications, the BT interface toolholders cater to different machining needs.

MAS 403 / JIS B 6339 / DIN ISO 7388-2

Features and benefits

Total system runout TIR $\leq 3 \mu\text{m}$ @ 3xD

Our holistic system consists of an micRun® toolholder, collet and clamping nut. All components together ensure best runout and accuracy.

Toolholder runout TIR $\leq 1 \mu\text{m}$

Measured from inner taper to outer taper.

Taper accuracy AT3

Better spindle-to-holder fit and accuracy.

Surface finish max. Ra 0.25

Achieve high clamping force and high transferable torque.

Balancing

100% balanced to G 2.5 @ 25,000 rpm / <1gmm.

MR clamping nut included in delivery

Guarantees highest clamping force and best balancing.

Vibration dampening

Our holders offer good vibration dampening to sustain a high surface finish and can help prevent chatter.

Accessories are not included in delivery

Balancing specifications

BT 30	balanced to 30,000 min ⁻¹
BT 40	G 2.5 @ 25,000 min ⁻¹



BT toolholders

BT

MAS 403

JIS B 6339

DIN ISO 7388-2

Type	Part no.	Dimensions [mm]		Accessory
		D	L	Freewheel wrench head
BT 30				
BT 30/MR 11 x 050	5130.11110	16	50	A-FLS Ø 16/MR 11
BT 30/MR 11 x 100	5130.11150	16	100	A-FLS Ø 16/MR 11
BT 30/MR 16 x 050	5130.11610	28	50	A-FLS Ø 28/MR 16
BT 30/MR 16 x 080	5130.11640	28	80	A-FLS Ø 28/MR 16
BT 30/MR 16 x 100	5130.11650	28	100	A-FLS Ø 28/MR 16
BT 30/MR 25 x 060	5130.12520	40	60	A-FLS Ø 40/MR 25
BT 30/MR 25 x 100	5130.12550	40	100	A-FLS Ø 40/MR 25
BT 30/MR 32 x 060	5130.13220	50	60	A-FLS Ø 50/MR 32
BT 40				
BT 40/MR 11 x 100	5140.11150	16	100	A-FLS Ø 16/MR 11
BT 40/MR 16 x 070	5140.11630	28	70	A-FLS Ø 28/MR 16
BT 40/MR 16 x 100	5140.11650	28	100	A-FLS Ø 28/MR 16
BT 40/MR 25 x 070	5140.12530	40	70	A-FLS Ø 40/MR 25
BT 40/MR 25 x 100	5140.12550	40	100	A-FLS Ø 40/MR 25
BT 40/MR 32 x 070	5140.13230	50	70	A-FLS Ø 50/MR 32
BT 40/MR 32 x 100	5140.13250	50	100	A-FLS Ø 50/MR 32

Included in delivery: MR toolholders come with Hi-Q®/MR clamping nut

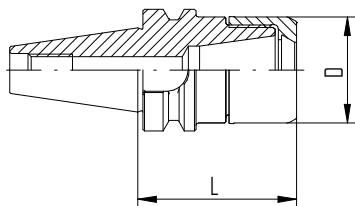

BT/MR (Form A+AD)

Expert advice

We recommend tightening the clamping nuts with our TORCO-BLOCK or torque wrench.
For recommended REGO-FIX accessories, please refer to page 237.

Steep taper toolholders CAT

Universally suitable for different machining applications.

ASME B5.50

Features and benefits

Total system runout TIR $\leq 0.0001"$ (3 μm)

Our holistic system consists of an micRun[®] toolholder, collet and clamping nut. All components together ensure best runout and accuracy.

Toolholder runout TIR $\leq 1 \mu\text{m}$

Measured from inner taper to outer taper.

Taper accuracy AT3

Better spindle-to-holder fit and accuracy.

Surface finish max. Ra 0.25

Achieve high clamping force and high transferable torque.

Balancing

100% balanced to G 2.5 @ 22,000 rpm.

MR clamping nut included in delivery

Guarantees highest clamping force and best balancing.

Vibration dampening

Our holders offer good vibration dampening to sustain a high surface finish and can help prevent chatter.

Accessories are not included in delivery



Type	Part no.	Dimensions [mm]		Accessory
		D	L	Freewheel wrench head
CAT 40*				
CAT 40/MR 16 x 3"	5340.11631	28	3"	A-FLS Ø 28/MR 16
CAT 40/MR 16 x 6"	5340.11671	28	6"	A-FLS Ø 28/MR 16
CAT 40/MR 32 x 3"	5340.13231	50	3"	A-FLS Ø 50/MR 32

*USA only

Included in delivery: MR toolholders come with Hi-Q®/MR clamping nut

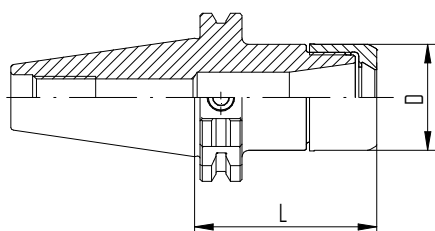

CAT / MR (form A+AD)

Cylindrical shank toolholders CYL

CYL

Features and benefits

Total system runout TIR $\leq 3\mu\text{m}$ @ 3xD

Our holistic system consists of an micRun® toolholder, collet and clamping nut. All components together ensure best runout and accuracy.

Toolholder runout TIR $\leq 1\mu\text{m}$

Measured from inner taper to cylindrical shank.

Surface finish max. Ra 0.25

Achieve high clamping force and high transferable torque.

Sizes

CYL/MR 11 and CYL/MRM 16

Application

CYL/MR is suited for Swiss automatic machines, machining centers and conventional machines.

MR clamping nut included in delivery

Guarantees maximum precision combined with slimmest diameter.

Vibration dampening

Our holders offer good vibration dampening to sustain a high surface finish and can help prevent chatter.

Accessories are not included in delivery

Expert advice

We recommend tightening the clamping nuts using a torque wrench. Get the best accuracy by respecting the suitable tightening forces.

For tightening torque recommendations, please refer to page 293.



Type	Part no.	Dimensions [mm]				G	Accessory
		D	L	L1	L2		Freewheel wrench head
CYL 16							
CYL 16 x 150/MR 11	5616.11190	16	150	17.2	20	M 8 x 1	A-FLS Ø 16/MR 11
CYL 16 x 200/MR 11	5616.11100	16	200	17.2	20	M 8 x 1	A-FLS Ø 16/MR 11
CYL 20							
CYL 20 x 150/MRM 16	5620.21690	24	150	25.2	25	M 12 x 1	A-FLS Ø 24/MRM 16
CYL 20 x 200/MRM 16	5620.21600	24	200	25.2	25	M 12 x 1	A-FLS Ø 24/MRM 16

Included in delivery: MR toolholders come with HI-Q® /MR clamping nut

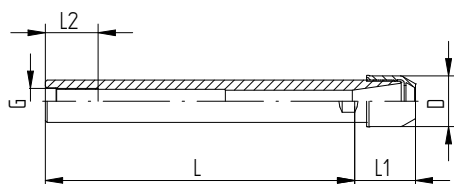

CYL/MR



Collets

MR



page 199



Swiss quality MR collets

Type	Part no.	[mm]	Ø [inch]
MR 11 [mm]			
Ø 1.0 mm	1111.01006	1.0	–
Ø 2.0 mm	1111.02006	2.0	–
Ø 3.0 mm	1111.03006	3.0	–
Ø 4.0 mm	1111.04006	4.0	–
Ø 5.0 mm	1111.05006	5.0	–
Ø 6.0 mm	1111.06006	6.0	–

MR 11 [inch]			
Ø 1/8"	1111.03186	3.175	1/8"
Ø 3/16"	1111.04766	4.763	3/16"
Ø 1/4"	1111.06356	6.35	1/4"

MR 16 [mm]			
Ø 1.0 mm	1116.01006	1.0	–
Ø 2.0 mm	1116.02006	2.0	–
Ø 3.0 mm	1116.03006	3.0	–
Ø 4.0 mm	1116.04006	4.0	–
Ø 5.0 mm	1116.05006	5.0	–
Ø 6.0 mm	1116.06006	6.0	–
Ø 8.0 mm	1116.08006	8.0	–
Ø 10.0 mm	1116.10006	10.0	–

MR 16 [inch]			
Ø 1/8"	1116.03186	3.175	1/8"
Ø 3/16"	1116.04766	4.763	3/16"
Ø 1/4"	1116.06356	6.35	1/4"
Ø 5/16"	1116.07946	7.938	5/16"
Ø 3/8"	1116.09536	9.525	3/8"

Expert advice

The micRun® MR collet represents the benchmark in precision: With a runout at (maximum) 2µm, it is the most accurate collet in the REGO-FIX lineup. MR collets are compatible with genuine REGO-FIX ER toolholders and increase the TIR of the entire system.

Type	Part no.	Ø [mm]	Ø [inch]
MR 25 [mm]			
Ø 1.0 mm	1125.01006	1.0	–
Ø 2.0 mm	1125.02006	2.0	–
Ø 3.0 mm	1125.03006	3.0	–
Ø 4.0 mm	1125.04006	4.0	–
Ø 5.0 mm	1125.05006	5.0	–
Ø 6.0 mm	1125.06006	6.0	–
Ø 8.0 mm	1125.08006	8.0	–
Ø 10.0 mm	1125.10006	10.0	–
Ø 12.0 mm	1125.12006	12.0	–
Ø 14.0 mm	1125.14006	14.0	–
Ø 16.0 mm	1125.16006	16.0	–





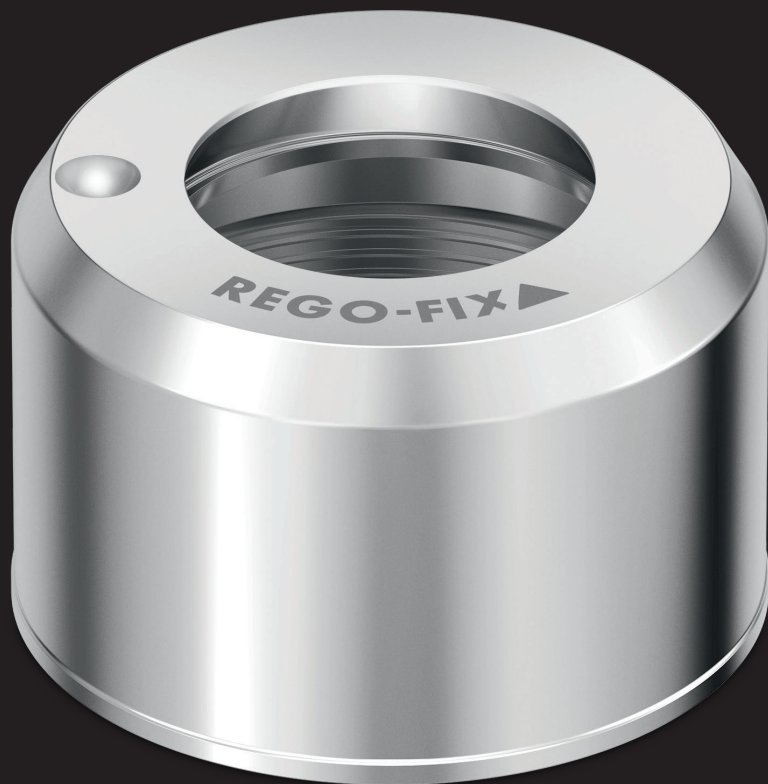

MR 25 [inch]			
Ø 1/8"	1125.03186	3.175	1/8"
Ø 1/4"	1125.06356	6.35	1/4"
Ø 5/16"	1125.07946	7.938	5/16"
Ø 3/8"	1125.09536	9.525	3/8"
Ø 7/16"	1125.11116	11.113	7/16"
Ø 1/2"	1125.12706	12.7	1/2"
Ø 9/16"	1125.14296	14.288	9/16"
Ø 5/8"	1125.15886	15.875	5/8"

MR 32 [mm]			
Ø 2.0 mm	1132.02006	2.0	–
Ø 3.0 mm	1132.03006	3.0	–
Ø 4.0 mm	1132.04006	4.0	–
Ø 5.0 mm	1132.05006	5.0	–
Ø 6.0 mm	1132.06006	6.0	–
Ø 8.0 mm	1132.08006	8.0	–
Ø 10.0 mm	1132.10006	10.0	–
Ø 12.0 mm	1132.12006	12.0	–
Ø 14.0 mm	1132.14006	14.0	–
Ø 16.0 mm	1132.16006	16.0	–
Ø 18.0 mm	1132.18006	18.0	–
Ø 20.0 mm	1132.20006	20.0	–

Type	Part no.	[mm]	∅ [inch]
MR 32 [inch]			
∅ 1/4"	1132.06356	6.35	1/4"
∅ 5/16"	1132.07946	7.938	5/16"
∅ 3/8"	1132.09536	9.525	3/8"
∅ 7/16"	1132.11116	11.113	7/16"
∅ 1/2"	1132.12706	12.7	1/2"
∅ 9/16"	1132.14296	14.288	9/16"
∅ 5/8"	1132.15886	15.875	5/8"
∅ 11/16"	1132.17466	17.463	11/16"
∅ 3/4"	1132.19056	19.05	3/4"





Standard		Mini nut		Sealing and coolant flush disks	
MR	MRC	MRM	MRMC	DS/MR	KS/MR
					
page 204	page 204	page 204	page 204	page 244	page 252

C: cooling M: mini thread DS: sealing disk KS: coolant flush disk

Grooveless MR nuts for high-end machining



	Hi-Q/MR	Hi-Q/MRC	Hi-Q/MRM	Hi-Q/MRMC
Main feature	Standard micRun® nut	micRun® nut for coolant through	micRun® mini nut	micRun® mini nut for coolant through
Sizes	MR 11/16/25/32	MR 11/16/25/32	MRM 16	MRM 16
Minimal outer diameter	–	–	•	•
Grooveless	•	•	•	•
Suitable wrench	A-FLS	A-FLS	A-FLS	A-FLS
Compatible with DS	–	•	–	•
Compatible with KS	–	•	–	•

Expert advice

Due to the thread, micRun® MR-clamping nuts are only compatible with MR-toolholders.

MR Clamping nuts

MRM Mini clamping nuts

MRC and MRMC clamping nuts for coolant through tools (DS/KS)

Type	Part no.	Dimensions [mm]		
		A	B	L1
MR 11				
Hi-Q/MR 11	3611.00000	16	16.2	4.5
MR 16				
Hi-Q/MR 16	3616.00000	28	23.1	6.7
MR 25				
Hi-Q/MR 25	3625.00000	40	25.5	8.1
MR 32				
Hi-Q/MR 32	3632.00000	50	31.8	9.1

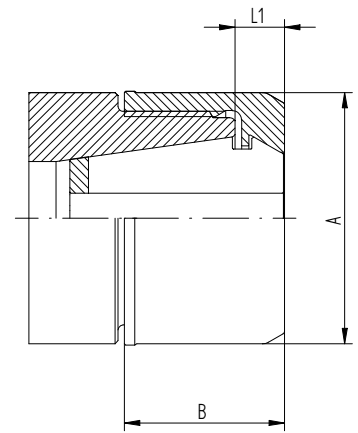

MR

Type	Part no.	Dimensions [mm]		
		A	B	L1
MRM 16				
Hi-Q/MRM 16	3616.80000	24	23.1	6.7



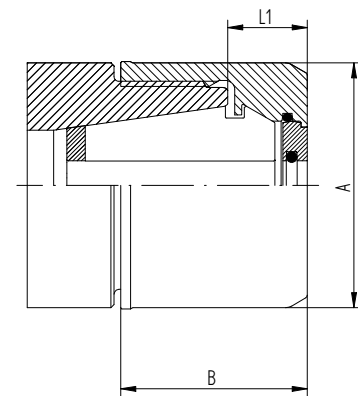









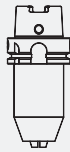

Type	Part no.	Dimensions [mm]		
		A	B	L1
MRC 16				
Hi-Q/MRC 16	3616.20000	28	28.1	11.7
MRC 25				
Hi-Q/MRC 25	3625.20000	40	30.5	13.1
MRC 32				
Hi-Q/MRC 32	3632.20000	50	36.8	14.1



MRC

Type	Part no.	Dimensions [mm]		
		A	B	L1
MRMC 16				
Hi-Q/MRMC 16	3616.90000	24	28.1	11.7

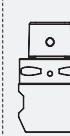
Experience Multi Line

HSK holders				SK holders				BT holders				CAPTO holders	
HSK/ WD	HSK/ KFD	HSK/ KBF	HSK/ MK	SK/ WD	SK/ KFD	SK/ KBF	SK/ MK	BT/ WD	BT/ KFD	BT/ KBF	BT/ MK	C/WD	C/MA
													
page 208	page 211	page 213	page 214	page 216	page 218	page 219	page 220	page 221	page 223	page 224	page 225	page 226	page 230

Reduction sleeves for hydro chucks

HS

HS-CF
with coolant flush



page 233

page 233

HSK holders

SK holders

BT holders

CAPTO holders

HSK/
WD

HSK/
KFD

HSK/
KBF

HSK/
MK

SK/
WD

SK/
KFD

SK/
KBF

SK/
MK

BT/
WD

BT/
KFD

BT/
KBF

BT/
MK

C/WD

C/MA



page 208

page 211

page 213

page 214

page 216

page 218

page 219

page 220

page 221

page 223

page 224

page 225

page 226

page 230

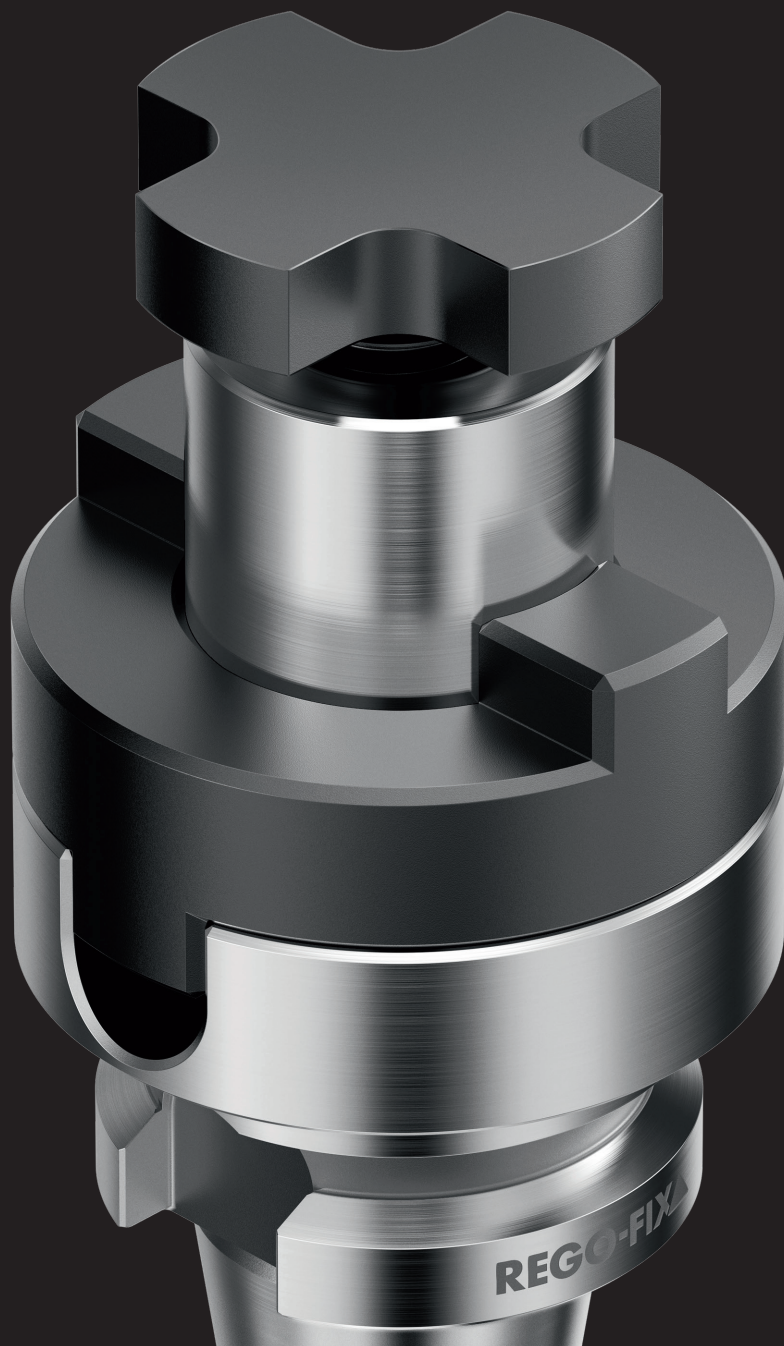

Toolholders and adapters



	WD	MA	KFD	KBF	MK
HSK	•	–	•	•	•
SK	•	–	•	•	•
BT	•	–	•	•	•
CAPTO	•	•	–	–	–
Balancing	Balanced by design	Balanced by design	Balanced by design	Balanced by design	Balanced by design
Diameter range	6–40	16–40	16–50	1–13	Mk1–Mk4

Weldon end mill holders HSK/WD

Designed for rotating applications, all our HSK holders are suited for high-speed applications where a consistent performance is key.

DIN 69893/ISO 12164

Features of end mill holders (Weldon)

Runout TIR $\leq 3 \mu\text{m}$

Measured from inner bore to outer taper.

Side locking screw

For highest transferable torque.

ID chip hole (only HSK form A)

In accordance with DIN 69873 for 10 mm diameter.
Available on request.

Expert advice

For all HSK-A and HSK-E form holders a range of coolant tubes (KSR) is available.

For KSR part numbers please refer to page 265.



Weldon end mill holders HSK-A/WD

HSK/WD

DIN 69893

ISO 12164

Type	Part no.	Dimensions [mm]			Drawing
		d	D	L	
HSK-A 32					
HSK-A 32/WD 6 x 055*	2532.30620	6	25	55	1
HSK-A 32/WD 8 x 055*	2532.30820	8	28	55	1
HSK-A 32/WD 10 x 063*	2532.31030	10	35	63	1
HSK-A 32/WD 12 x 065*	2532.31230	12	42	65	1
HSK-A 40					
HSK-A 40/WD 6 x 060	2540.30630	6	25	60	1
HSK-A 40/WD 8 x 060	2540.30830	8	28	60	1
HSK-A 40/WD 10 x 060	2540.31030	10	35	60	1
HSK-A 40/WD 12 x 070	2540.31240	12	42	70	1
HSK-A 40/WD 14 x 075	2540.31440	14	44	75	1
HSK-A 40/WD 16 x 075	2540.31640	16	48	75	1
HSK-A 50					
HSK-A 50/WD 12 x 080	2550.31250	12	42	80	1
HSK-A 50/WD 14 x 080	2550.31450	14	44	80	1
HSK-A 50/WD 18 x 080	2550.31850	18	50	80	1
HSK-A 63					
HSK-A 63/WD 6 x 065	2563.30630	6	25	65	1
HSK-A 63/WD 8 x 065	2563.30830	8	28	65	1
HSK-A 63/WD 10 x 065	2563.31030	10	35	65	1
HSK-A 63/WD 12 x 080	2563.31250	12	42	80	1
HSK-A 63/WD 14 x 080	2563.31450	14	44	80	1
HSK-A 63/WD 16 x 080	2563.31650	16	48	80	1
HSK-A 63/WD 18 x 080	2563.31850	18	50	80	1
HSK-A 63/WD 20 x 080	2563.32050	20	52	80	1
HSK-A 63/WD 25 x 110	2563.32560	25	65	110	2
HSK-A 63/WD 32 x 110	2563.33260	32	72	110	2

*HSK taper without side hole

Weldon end mill holders

HSK-A/WD and HSK-E/WD

HSK/WD

DIN 69893

ISO 12164

Type	Part no.	Dimensions [mm]			Drawing
		d	D	L	
HSK-A 100					
HSK-A 100/WD 6 x 080	2500.30650	6	25	80	1
HSK-A 100/WD 8 x 080	2500.30850	8	28	80	1
HSK-A 100/WD 10 x 080	2500.31050	10	35	80	1
HSK-A 100/WD 12 x 080	2500.31250	12	42	80	1
HSK-A 100/WD 14 x 080	2500.31450	14	44	80	1
HSK-A 100/WD 16 x 100	2500.31660	16	48	100	1
HSK-A 100/WD 18 x 100	2500.31860	18	50	100	1
HSK-A 100/WD 20 x 100	2500.32060	20	52	100	1
HSK-A 100/WD 25 x 100	2500.32560	25	65	100	2
HSK-A 100/WD 32 x 100	2500.33260	32	72	100	2
HSK-A 100/WD 40 x 110	2500.34060	40	80	110	2
HSK-E 40					
HSK-E 40/WD 10 x 060	2540.31034	10	35	60	1
HSK-E 40/WD 12 x 070	2540.31244	12	42	70	1
HSK-E 40/WD 16 x 070	2540.31644	16	48	70	1

Included in delivery: End mill holder and lock screw

HSK-A: Hole for data carrier DIN STD 69873 in the flange available on request

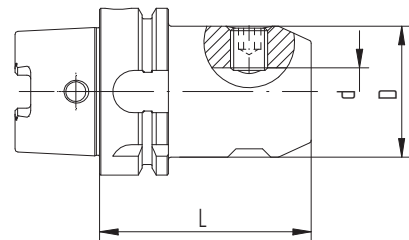

Drawing 1 HSK-A/WD

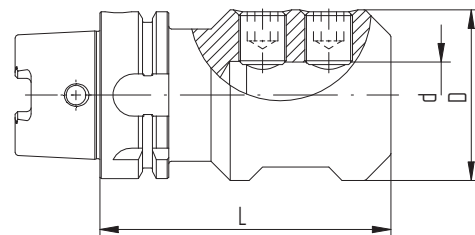

Drawing 2 HSK-A/WD

Universal shell/face mill holders

HSK-A/KFD and HSK-E/KFD

HSK/KFD

DIN 69893

ISO 12164

Type	Part no.	Dimensions [mm]			Drawing	Accessories
		D	D1	L		Wrench
HSK-A 32						
HSK-A 32/KFD 16 x 045	2532.41620	16	32	45	1	FDS 16
HSK-A 32/KFD 22 x 050	2532.42230	22	40	50	1	FDS 22
HSK-A 40						
HSK-A 40/KFD 16 x 030	2540.41600	16	32	30	1	FDS 16
HSK-A 40/KFD 22 x 050	2540.42230	22	40	50	1	FDS 22
HSK-A 50						
HSK-A 50/KFD 16 x 050	2550.41630	16	32	50	1	FDS 16
HSK-A 50/KFD 22 x 050	2550.42230	22	40	50	1	FDS 22
HSK-A 50/KFD 32 x 065	2550.43240	32	58	65	2	FDS 32
HSK-A 63						
HSK-A 63/KFD 16 x 060	2563.41640	16	32	60	1	FDS 16
HSK-A 63/KFD 22 x 060	2563.42240	22	40	60	1	FDS 22
HSK-A 63/KFD 27 x 060	2563.42740	27	48	60	1	FDS 27
HSK-A 63/KFD 32 x 060	2563.43240	32	58	60	1	FDS 32
HSK-A 63/KFD 40 x 070	2563.44050	40	70	70	2	FDS 40
HSK-A 100						
HSK-A 100/KFD 16 x 060	2500.41640	16	32	60	1	FDS 16
HSK-A 100/KFD 22 x 060	2500.42240	22	40	60	1	FDS 22
HSK-A 100/KFD 27 x 060	2500.42740	27	48	60	1	FDS 27
HSK-A 100/KFD 32 x 060	2500.43240	32	58	60	1	FDS 32
HSK-A 100/KFD 40 x 070	2500.44050	40	70	70	1	FDS 40
HSK-A 100/KFD 50 x 080	2500.45060	50	90	80	2	FDS 50
HSK-E 40						
HSK-E 40/KFD 16 x 045	2540.41624	16	32	45	–	FDS 16

Included in delivery: Universal shell/face mill holder, lock screw, feather key and drive ring

For details on our FDS wrenches, please refer to page 259

HSK-A: Hole for data carrier DIN STD 69873 in the flange available on request

Universal shell/face mill holders HSK-A/KFD and HSK-E/KFD

HSK/KFD

DIN 69893

ISO 12164

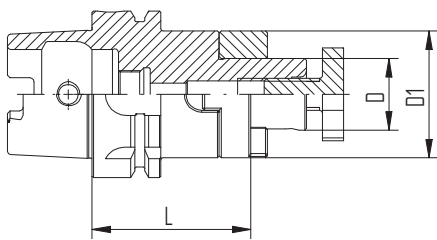

Drawing 1 HSK-A/KFD

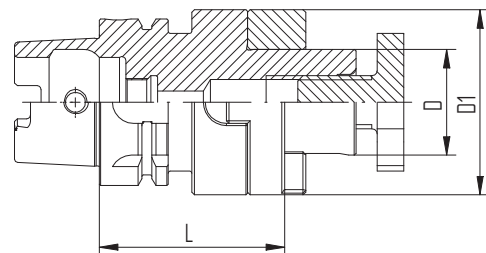

Drawing 2 HSK-A/KFD

Drill chucks HSK-A/KBF

HSK-A/KBF

DIN 69893

ISO 12164

Type	Part no.	d	Dimensions [mm]	
			D	L
HSK-A 63 / KBF				
HSK-A 63 / KBF 1 – 13 mm	2563.50100	1–13	50	104

Included in delivery: Drill chuck and Allen key™

HSK-A: Hole for data carrier DIN STD 69873 in the flange available on request

Drill chucks HSK-A/KBF

Features and benefits

Clamping range

1–13 mm

Runout TIR

0.03 mm

Maximum tightening torque

20 Nm

Clamping force (at 20 Nm tightening torque)

80 Nm

Maximum rpm

35,000 min⁻¹



HSK-A/KBF

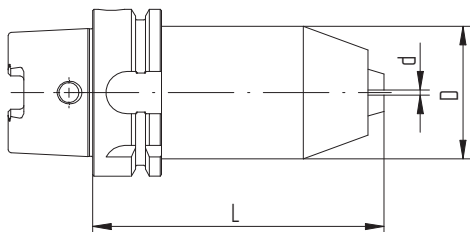

HSK-A/KBF

Morse taper holders HSK-A/MK

HSK-A/MK

DIN 69893

ISO 12164

Type	Part no.	Dimensions [mm]	
		D	L
HSK-A 63/MK			
HSK-A 63/MK 1 x 100	2563.80140	25	100
HSK-A 63/MK 2 x 120	2563.80250	32	120
HSK-A 63/MK 3 x 140	2563.80360	40	140
HSK-A 63/MK 4 x 160	2563.80470	48	160

HSK-A: Hole for data carrier DIN STD 69873 in the flange available on request

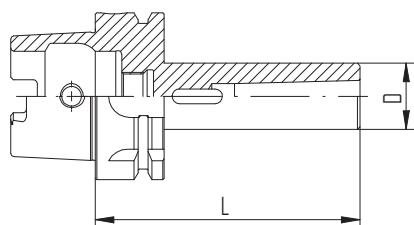

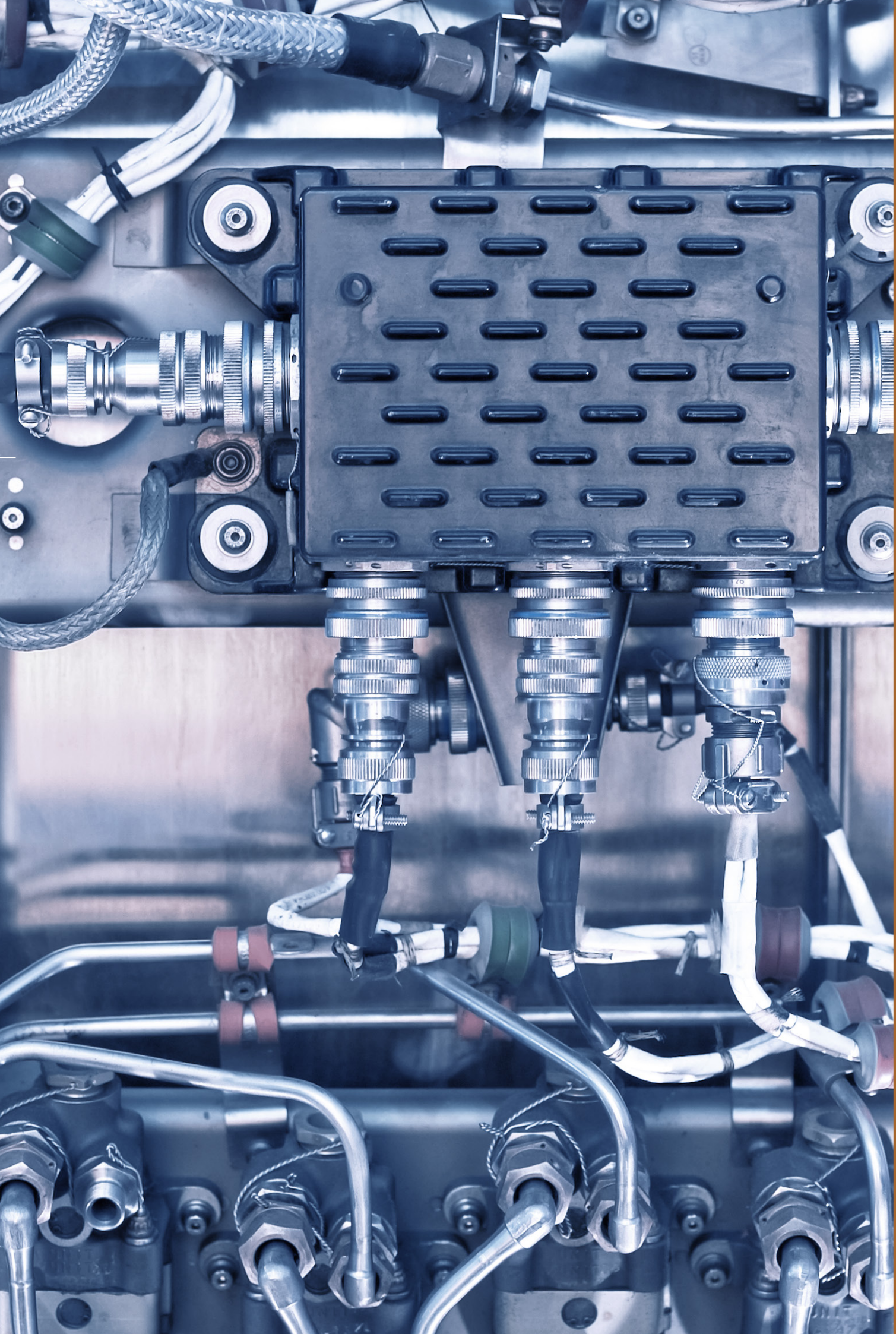

Weldon end mill holders SK/WD

Universally suitable for different machining applications.

DIN 69871 / DIN ISO 7388-1

Features of end mill holders (Weldon)

Runout TIR $\leq 3 \mu\text{m}$

Measured from inner bore to outer taper.

Taper accuracy AT3

Better spindle-to-holder fit and accuracy.

Side locking screw

For highest transferable torque.

Coolant supply

All toolholders with form A+AD can be used for cooling. Form A+AD delivers the coolant supply through the taper.

ID chip hole

In accordance with DIN 69873 for 10 mm diameter.



Weldon end mill holders SK/WD

SK/WD

DIN 69871

DIN ISO 7388-1

Type	Part no.	Dimensions [mm]			Form A+AD	Drawing
		D	d	L		
SK 40						
SK 40/WD 6 x 050	2240.30620	25	6	50	•	1
SK 40/WD 8 x 050	2240.30820	28	8	50	•	1
SK 40/WD 10 x 050	2240.31020	35	10	50	•	1
SK 40/WD 12 x 050	2240.31220	42	12	50	•	1
SK 40/WD 14 x 050	2240.31420	44	14	50	•	1
SK 40/WD 16 x 063	2240.31630	48	16	63	•	1
SK 40/WD 18 x 063	2240.31830	50	18	63	•	1
SK 40/WD 20 x 063	2240.32030	52	20	63	•	1
SK 40/WD 25 x 100	2240.32560	65	25	100	•	2
SK 40/WD 32 x 100	2240.33260	72	32	100	•	2

SK 50						
SK 50/WD 6 x 063	2250.30630	25	6	63	•	1
SK 50/WD 8 x 063	2250.30830	28	8	63	•	1
SK 50/WD 10 x 063	2250.31030	35	10	63	•	1
SK 50/WD 12 x 063	2250.31230	42	12	63	•	1
SK 50/WD 14 x 063	2250.31430	44	14	63	•	1
SK 50/WD 16 x 063	2250.31630	48	16	63	•	1
SK 50/WD 18 x 063	2250.31830	50	18	63	•	1
SK 50/WD 20 x 063	2250.32030	52	20	63	•	1
SK 50/WD 25 x 080	2250.32550	65	25	80	•	2
SK 50/WD 32 x 100	2250.33260	72	32	100	•	2
SK 50/WD 40 x 100	2250.34060	80	40	100	•	2

Included in delivery: End mill holder and lock screw

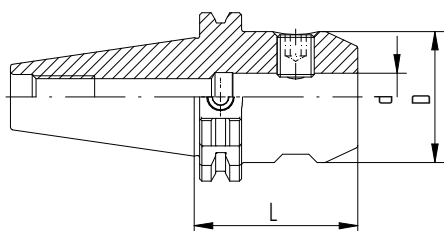

Drawing 1 SK/WD

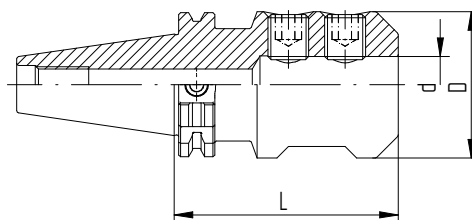

Drawing 2 SK/WD

Universal shell/face mill holders SK/KFD

SK/KFD

DIN 69871

DIN ISO 7388-1

Type	Part no.	Dimensions [mm]				Form A+AD	Drawing	Accessory
		D	D1	L	Wrench			
SK 40								
SK 40/KFD 16 x 055	2240.41630	16	32	55	•	1	FDS 16	
SK 40/KFD 22 x 055	2240.42230	22	40	55	•	1	FDS 22	
SK 40/KFD 27 x 055	2240.42730	27	48	55	•	1	FDS 27	
SK 40/KFD 32 x 060	2240.43240	32	58	60	•	2	FDS 32	
SK 40/KFD 40 x 060	2240.44040	40	70	60	•	2	FDS 40	
SK 50								
SK 50/KFD 16 x 055	2250.41630	16	32	55	•	1	FDS 16	
SK 50/KFD 22 x 055	2250.42230	22	40	55	•	1	FDS 22	
SK 50/KFD 27 x 055	2250.42730	27	48	55	•	1	FDS 27	
SK 50/KFD 32 x 055	2250.43230	32	58	55	•	1	FDS 32	
SK 50/KFD 40 x 055	2250.44030	40	70	55	•	1	FDS 40	
SK 50/KFD 50 x 070	2250.45050	50	90	70	•	2	FDS 50	

Included in delivery: Universal shell/face mill holder, lock screw, feather key and drive ring

For details on our FDS wrenches, please refer to page 259

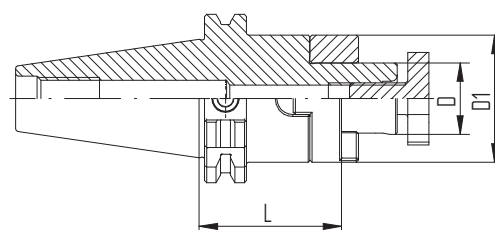

Drawing 1 SK/KFD

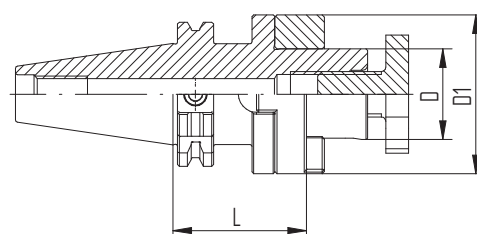

Drawing 2 SK/KFD

Drill chucks SK / KBF

SK / KBF

DIN 69871

DIN ISO 7388-1

Type	Part no.	Dimensions [mm]				
		D	d	L	Form A	Form A+AD
SK 30						
SK 30/KBF 1 – 13 mm	2230.50100	50	1–13	111	•	–
SK 40						
SK 40/KBF 1 – 13 mm	2240.50103	50	1–13	90	–	•
SK 50						
SK 50/KBF 1 – 13 mm	2250.50103	50	1–13	106	–	•

Included in delivery: Drill chuck and Allen key™

Drill chucks SK / KBF

Features and benefits

Clamping range

1–13 mm

Runout TIR

0.03 mm

Maximum tightening torque

20 Nm

Clamping force (at 20 Nm tightening torque)

80 Nm

Maximum rpm

35,000 min⁻¹



SK / KBF

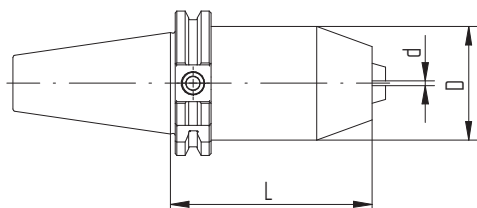

SK / KBF

Morse taper holders SK/MK

SK/MK

DIN 69871

DIN ISO 7388-1

Type	Part no.	Dimensions [mm]	
		D	L
SK 40			
SK 40/MK 1 x 050	2240.80110	25	50
SK 40/MK 2 x 050	2240.80210	32	50
SK 40/MK 3 x 070	2240.80320	40	70
SK 40/MK 4 x 095	2240.80430	48	95

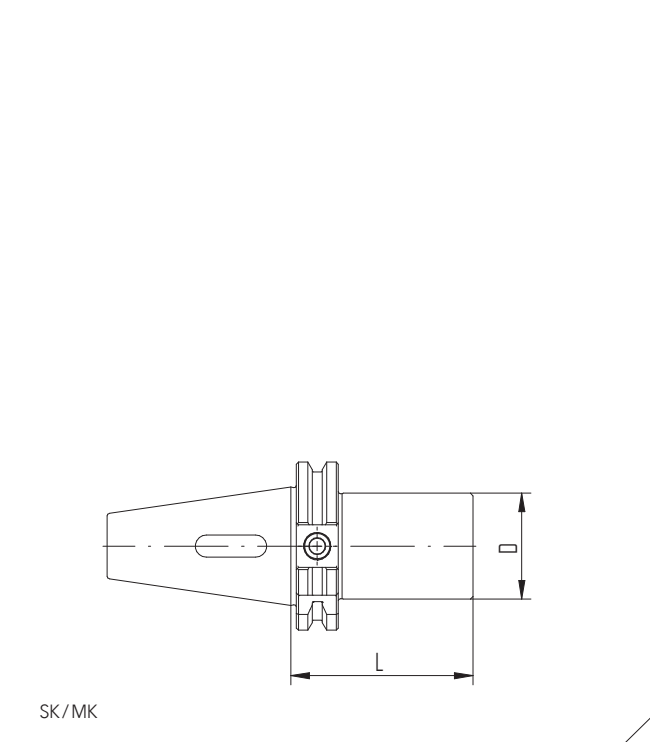

Weldon end mill holders BT/WD

Universally suitable different machining applications, the BT interface toolholders cater to different machining needs.

MAS 403 / JIS B 6339 / DIN ISO 7388-2

Features of end mill holders (Weldon)

Runout TIR $\leq 3 \mu\text{m}$

Measured from inner bore to outer taper.

Taper accuracy AT3

Better spindle-to-holder fit and accuracy.

Side locking screw

For highest transferable torque.

Coolant supply

All toolholders with form A+AD can be used for cooling. Form A+AD delivers the coolant supply through the taper.

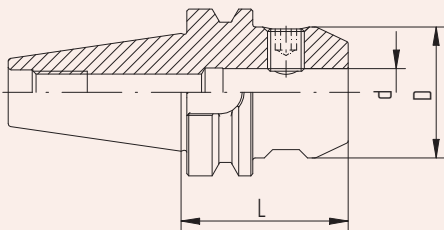

Drawing 1 BT/WD

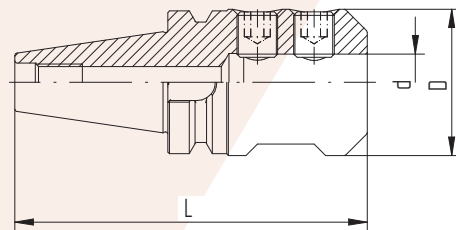

Drawing 2 BT/WD

Weldon end mill holders BT/WD

BT/WD

MAS 403

JIS B 6339

DIN ISO 7388-2

Type	Part no.	Dimensions [mm]			Form A+AD	Drawing
		D	d	L		
BT 30						
BT 30/WD 6 x 050	2130.30620	25	6	50	•	1
BT 30/WD 8 x 050	2130.30820	28	8	50	•	1
BT 30/WD 10 x 050	2130.31020	35	10	50	•	1
BT 30/WD 12 x 050	2130.31220	42	12	50	•	1
BT 30/WD 14 x 050	2130.31420	44	14	50	•	1
BT 30/WD 16 x 063	2130.31630	48	16	63	•	1
BT 30/WD 18 x 063	2130.31830	50	18	63	•	1
BT 30/WD 20 x 063	2130.32030	52	20	63	•	1
BT 40						
BT 40/WD 6 x 050	2140.30620	25	6	50	•	1
BT 40/WD 8 x 050	2140.30820	28	8	50	•	1
BT 40/WD 10 x 063	2140.31030	35	10	63	•	1
BT 40/WD 12 x 063	2140.31230	42	12	63	•	1
BT 40/WD 14 x 063	2140.31430	44	14	63	•	1
BT 40/WD 16 x 063	2140.31630	48	16	63	•	1
BT 40/WD 18 x 063	2140.31830	50	18	63	•	1
BT 40/WD 20 x 063	2140.32030	52	20	63	•	1
BT 40/WD 25 x 090	2140.32550	65	25	90	•	2
BT 40/WD 32 x 100	2140.33260	72	32	100	•	2
BT 50						
BT 50/WD 6 x 063	2150.30630	25	6	63	•	1
BT 50/WD 8 x 063	2150.30830	28	8	63	•	1
BT 50/WD 10 x 063	2150.31030	35	10	63	•	1
BT 50/WD 12 x 080	2150.31250	42	12	80	•	1
BT 50/WD 14 x 080	2150.31450	44	14	80	•	1
BT 50/WD 16 x 080	2150.31650	48	16	80	•	1
BT 50/WD 18 x 080	2150.31850	50	18	80	•	1
BT 50/WD 20 x 080	2150.32050	52	20	80	•	1
BT 50/WD 25 x 100	2150.32560	65	25	100	•	2
BT 50/WD 32 x 105	2150.33260	72	32	105	•	2
BT 50/WD 40 x 110	2150.34060	80	40	110	•	2

Included in delivery: End mill holder and lock screw

Universal shell/face mill holders BT/KFD

BT/KFD

MAS 403

JIS B 6339

DIN ISO 7388-2

Type	Part no.	Dimensions [mm]					Accessory	
		D	D1	L	Form A+AD	Drawing	Wrench	
BT 30								
BT 30/KFD 16 x 045	2130.41620	16	32	45	•	1	FDS 16	
BT 30/KFD 22 x 047	2130.42220	22	40	47	•	1	FDS 22	
BT 30/KFD 27 x 049	2130.42720	27	48	49	•	2	FDS 27	
BT 30/KFD 32 x 053	2130.43230	32	58	53	•	2	FDS 32	
BT 40								
BT 40/KFD 16 x 055	2140.41630	16	32	55	•	1	FDS 16	
BT 40/KFD 22 x 055	2140.42230	22	40	55	•	1	FDS 22	
BT 40/KFD 27 x 055	2140.42730	27	48	55	•	1	FDS 27	
BT 40/KFD 32 x 060	2140.43240	32	58	60	•	1	FDS 32	
BT 40/KFD 40 x 060	2140.44040	40	70	60	•	2	FDS 40	
BT 50								
BT 50/KFD 16 x 070	2150.41630	16	32	70	•	1	FDS 16	
BT 50/KFD 22 x 070	2150.42230	22	40	70	•	1	FDS 22	
BT 50/KFD 27 x 070	2150.42750	27	48	70	•	1	FDS 27	
BT 50/KFD 32 x 070	2150.43250	32	58	70	•	1	FDS 32	
BT 50/KFD 40 x 070	2150.44050	40	70	70	•	1	FDS 40	
BT 50/KFD 50 x 070	2150.45050	50	90	70	•	1	FDS 50	

For details on our FDS wrenches, please refer to page 259

Included in delivery: Universal shell/face mill holder, lock screw, feather key and drive ring

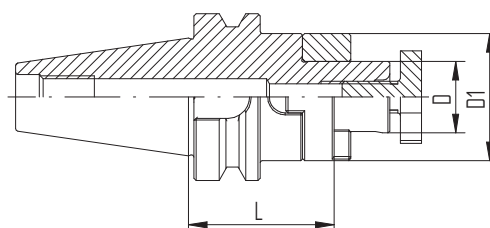

Drawing 1 BT/KFD

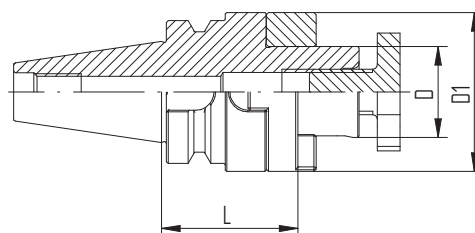

Drawing 2 BT/KFD

Drill chucks BT /KBF

BT /KBF

MAS 403

JIS B 6339

DIN ISO 7388-2

Type	Part no.	d	Dimensions [mm]			
			D	L	Form A	Form A+AD
BT 30						
BT 30/KBF 1 – 13 mm	2130.50100	1–13	50	95	•	–
BT 40						
BT 40/KBF 1 – 13 mm	2140.50103	1– 13	50	98	–	•
BT 50						
BT 50/KBF 1 – 13 mm	2150.50103	1– 13	50	100	–	•

Included in delivery: Drill chuck and Allen key™

Drill chucks BT /KBF

Features and benefits

Clamping range

1–13 mm

Runout TIR

0.03 mm

Maximum tightening torque

20 Nm

Clamping force (at 20 Nm tightening torque)

80 Nm

Maximum rpm

35,000 min⁻¹



BT /KBF

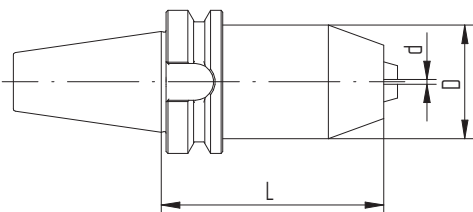

BT /KBF

Morse taper holders BT / MK

BT / MK

MAS 403

JIS B 6339

DIN ISO 7388-2

Type	Part no.	Dimensions [mm]	
		D	L
BT 40			
BT 40/MK 1 x 050	2140.80110	25	50
BT 40/MK 2 x 050	2140.80210	32	50
BT 40/MK 3 x 070	2140.80320	40	70
BT 40/MK 4 x 095	2140.80430	48	95

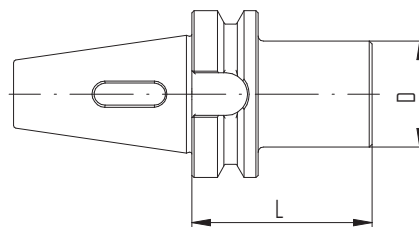

Type	Part no.	G	Dimensions [mm]	
			D	L
Tangs ATL				
ATL 6/MK 1	7221.01000	M 6	8,5	21,5
ATL 10/MK 2	7221.02000	M 10	13,5	30,5
ATL 12/MK 3	7221.03000	M 12	18,5	35
ATL 16/MK 4	7221.04000	M 16	24,5	41
ATL 20/MK 5	7221.05000	M 20	35	52

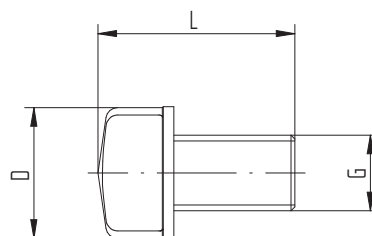

C/WD

REGO-FIX CAPTO licensed by Sandvik Coromant

End mill holders REGO-FIX C/WD

These self-centering and balanced holders enable a high torque transmission and show a high bending strength.

ISO 12164

Features of end mill holders (Weldon)

Runout TIR $\leq 3 \mu\text{m}$

Measured from inner bore to outer taper.

Side locking screw

For highest transferable torque.

Certified REGO-FIX CAPTO – licensed by Sandvik Coromant – is manufactured at REGO-FIX Switzerland under license according to CAPTO specifications.



End mill holders REGO-FIX C/WD

Type	Part no.	Dimensions [mm]			Drawing
		D1	d	L	
C3					
C3/WD 6 x 045	2803.30610	25	6	45	1
C3/WD 8 x 045	2803.30810	28	8	45	1
C3/WD 10 x 050	2803.31020	35	10	50	1
C3/WD 12 x 055	2803.31220	42	12	55	1
C4					
C4/WD 6 x 050	2804.30620	25	6	50	1
C4/WD 8 x 050	2804.30820	28	8	50	1
C4/WD 10 x 050	2804.31020	35	10	50	1
C4/WD 12 x 055	2804.31220	42	12	55	1
C4/WD 14 x 055	2804.31420	44	14	55	1
C4/WD 16 x 055	2804.31620	48	16	55	1
C5					
C5/WD 6 x 050	2805.30620	25	6	50	1
C5/WD 8 x 050	2805.30820	28	8	50	1
C5/WD 10 x 055	2805.31020	35	10	55	1
C5/WD 12 x 060	2805.31230	42	12	60	1
C5/WD 14 x 060	2805.31430	44	14	60	1
C5/WD 16 x 060	2805.31630	48	16	60	1
C5/WD 18 x 060	2805.31830	50	18	60	1
C5/WD 20 x 060	2805.32030	52	20	60	1
C5/WD 25 x 080	2805.32550	65	25	80	2

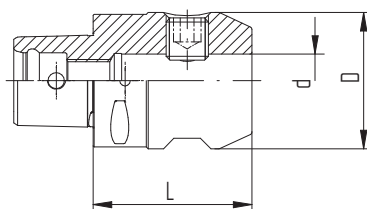

Drawing 1 C/WD

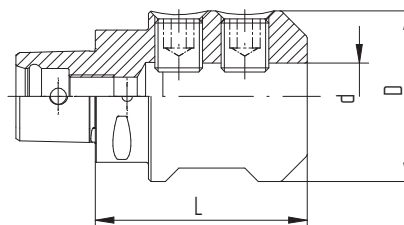

Drawing 2 C/WD

End mill holders REGO-FIX C/WD

Type	Part no.	Dimensions [mm]			Drawing
		D1	d	L	
C6					
C6/WD 6 x 055	2806.30620	25	6	55	1
C6/WD 8 x 055	2806.30820	28	8	55	1
C6/WD 10 x 060	2806.31030	35	10	60	1
C6/WD 12 x 060	2806.31230	42	12	60	1
C6/WD 14 x 060	2806.31430	44	14	60	1
C6/WD 16 x 065	2806.31630	48	16	65	1
C6/WD 18 x 065	2806.31830	50	18	65	1
C6/WD 20 x 065	2806.32030	52	20	65	1
C6/WD 25 x 080	2806.32550	65	25	80	2
C6/WD 32 x 090	2806.33250	72	32	90	2
C6/WD 40 x 100	2806.34060	80	40	100	2

C8					
C8/WD 6 x 070	2808.30640	25	6	70	1
C8/WD 8 x 070	2808.30840	28	8	70	1
C8/WD 10 x 070	2808.31040	35	10	70	1
C8/WD 12 x 070	2808.31240	42	12	70	1
C8/WD 14 x 070	2808.31440	44	14	70	1
C8/WD 16 x 070	2808.31640	48	16	70	1
C8/WD 18 x 070	2808.31840	50	18	70	1
C8/WD 20 x 070	2808.32040	52	20	70	1
C8/WD 25 x 080	2808.32550	65	25	80	2
C8/WD 32 x 080	2808.33250	72	32	80	2
C8/WD 40 x 110	2808.34060	80	40	110	2

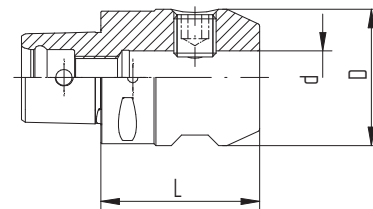

Drawing 1 C/WD

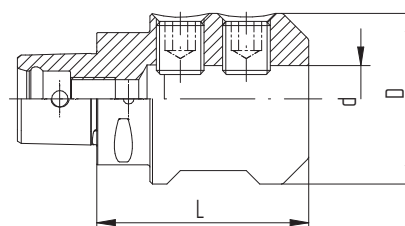

Drawing 2 C/WD

Shell mill arbors REGO-FIX C/MA

Type	Part no.	Dimensions [mm]				Drawing
		D	D1	L	L1	
C3						
C3/MA 16 x 030	2803.01610	16	36	30	11	2
C4						
C4/MA 16 x 032	2804.01610	16	36	32	11	1
C4/MA 16 x 055	2804.01620	16	36	55	11	1
C4/MA 22 x 025	2804.02210	22	48	25	16	2
C4/MA 22 x 055	2804.02220	22	48	55	16	2
C5						
C5/MA 16 x 035	2805.01610	16	36	35	11	1
C5/MA 16 x 070	2805.01640	16	36	70	11	1
C5/MA 22 x 025	2805.02210	22	50	25	16	1
C5/MA 22 x 070	2805.02240	22	48	70	16	1
C5/MA 27 x 025	2805.02710	27	56	25	18	2
C5/MA 32 x 040	2805.03210	32	65	40	20	2

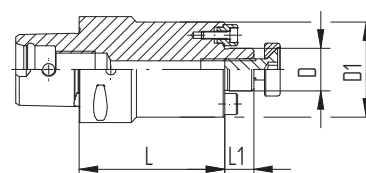

Drawing 1 C/MA

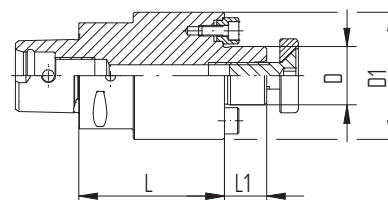

Drawing 2 C/MA

Shell mill arbors REGO-FIX C/MA

Type	Part no.	Dimensions [mm]				Drawing
		D	D1	L	L1	
C6						
C6/MA 16 x 040	2806.01610	16	36	40	11	1
C6/MA 22 x 025	2806.02210	22	55	25	16	1
C6/MA 27 x 025	2806.02710	27	63	25	18	1
C6/MA 32 x 025	2806.03210	32	65	25	20	2
C6/MA 40 x 040	2806.04010	40	80	40	23	2
C8						
C8/MA 16 x 050	2808.01620	16	36	50	11	1
C8/MA 22 x 030	2808.02210	22	55	30	16	1
C8/MA 27 x 030	2808.02710	27	65	30	18	1
C8/MA 32 x 030	2808.03210	32	80	30	20	1
C8/MA 40 x 030	2808.04010	40	80	30	23	1

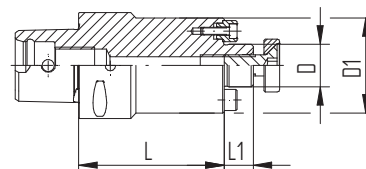

Drawing 1 C/MA

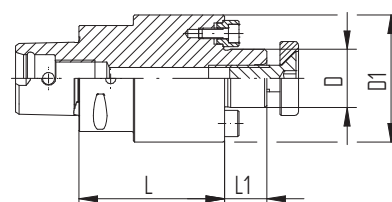

Drawing 2 C/MA



**Reduction sleeves
for hydro chucks**

HS



page 233

HS-CF
with coolant flush



page 233



Reduction sleeves for hydro chucks

Reduction sleeves are designed to fit hydro chucks of different manufacturers. They are specially suited for high-precision clamping of cylindrical tool shanks.

Reduction sleeves for hydro chucks Our reduction sleeves are designed to fit hydro chucks of different manufacturers. They are specially suited for high-precision clamping of cylindrical tool shanks per DIN 6335 form HA, HB and HE, as well as tool shanks per DIN 1835 form B, C, D and E.

The special design of REGO-FIX reduction sleeves allows an efficient use of coolant through cutting tools. This self-sealing system works with the most common hydraulic expansion chucks.

- Correct assembly** Improper assembly can damage the concentricity of the reduction sleeve.
- // Insert tools the full length of the reduction sleeve
 - // Only clamp h6 tool shanks
 - // Do not clamp reduction sleeve without a tool, as this could result in a damaged reduction sleeve

Concentricity (TIR) of REGO-FIX HS type reduction sleeves

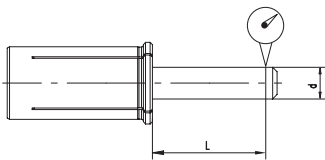

Clamping diameter d [mm]			max. TIR
> d	≤ d	L	[mm]
3.0	6.0	16	0.003
6.0	10.0	25	0.003
10.0	18.0	40	0.003
18.0	26.0	50	0.003



Swiss quality standard
Our products marked Swiss made are manufactured at our headquarters in Tenniken, Switzerland.

Reductions sleeves for hydro chucks HS

Features and benefits

Accurate precision

Runout TIR <math>< 3 \mu\text{m}</math>

High flexibility

Clamp different tool shank diameters in hydro chucks: 12, 20, 25 and 32 mm.

Standard version HS suited for internal cooling

Metal-to-metal seal for cutting tools with internal coolant channels.

HS-CF suited for peripheral cooling

The coolant flush reductions sleeves HS-CF can be used for peripheral cooling due to their coolant channels.

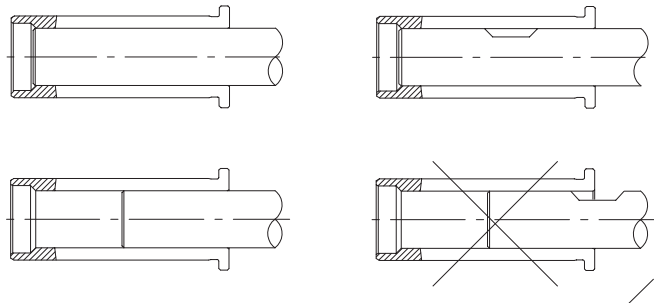

Comparison of transferable torque at Ø 20 mm



Direct clamping

Shank Ø 20 mm in toolholder Ø 20 mm

Reduction sleeve 32/20

Shank Ø 20 mm in toolholder Ø 32 mm

Reduction sleeves HS and HS-CF [metric]

HS

Ø bore [mm]	Part no.							
	HS 12-MB	HS 12	HS 12-CF	HS 20	HS 20-CF	HS 25	HS 32	HS 32-CF
1.0	1912.01009	-	-	-	-	-	-	-
1.5	1912.01509	-	-	-	-	-	-	-
2.0	1912.02009	-	-	-	-	-	-	-
2.5	1912.02509	-	-	-	-	-	-	-
3.0	-	1912.03000	1912.03002	1920.03000	1920.03002	1925.03000	1932.03000	-
4.0	-	1912.04000	1912.04002	1920.04000	1920.04002	1925.04000	1932.04000	-
5.0	-	1912.05000	1912.05002	1920.05000	1920.05002	1925.05000	1932.05000	-
6.0	-	1912.06000	1912.06002	1920.06000	1920.06002	1925.06000	1932.06000	1932.06002
7.0	-	1912.07000	-	1920.07000	-	1925.07000	1932.07000	-
8.0	-	1912.08000	1912.08002	1920.08000	1920.08002	1925.08000	1932.08000	1932.08002
9.0	-	1912.09000	-	1920.09000	-	1925.09000	1932.09000	-
10.0	-	1912.10000	-	1920.10000	1920.10002	1925.10000	1932.10000	1932.10002
11.0	-	-	-	1920.11000	-	-	1932.11000	-
12.0	-	-	-	1920.12000	1920.12002	1925.12000	1932.12000	1932.12002
13.0	-	-	-	1920.13000	-	-	1932.13000	-
14.0	-	-	-	1920.14000	1920.14002	1925.14000	1932.14000	1932.14002
15.0	-	-	-	1920.15000	-	-	1932.15000	-
16.0	-	-	-	1920.16000	1920.16002	1925.16000	1932.16000	1932.16002
17.0	-	-	-	-	-	-	1932.17000	-
18.0	-	-	-	1920.18000	-	1925.18000	1932.18000	1932.18002
19.0	-	-	-	-	-	-	1932.19000	-
20.0	-	-	-	-	-	1925.20000	1932.20000	1932.20002
21.0	-	-	-	-	-	-	-	-
22.0	-	-	-	-	-	-	1932.22000	-
23.0	-	-	-	-	-	-	-	-
24.0	-	-	-	-	-	-	-	-
25.0	-	-	-	-	-	-	1932.25000	1932.25002

For further technical information, please refer to page 301 and 303



Reduction sleeves HS [inch]

HS

Ø bore		Part no.			
[decimal "]	[inch]	HS 12	HS 20	HS 25	HS 32
0.125	1/8"	1912.03181	1920.03181	1925.03181	–
0.1875	3/16"	1912.04761	1920.04761	1925.04761	1932.04761
0.25	1/4"	1912.06351	1920.06351	1925.06351	1932.06351
0.3125	5/16"	1912.07941	1920.07941	1925.07941	1932.07941
0.375	3/8"	1912.09521	1920.09521	1925.09521	1932.09521
0.4375	7/16"	–	1920.11111	1925.11111	1932.11111
0.5	1/2"	–	1920.12701	1925.12701	1932.12701
0.5625	9/16"	–	1920.14291	1925.14291	1932.14291
0.625	5/8"	–	1920.15881	1925.15881	1932.15881
0.6875	11/16"	–	–	1925.17461	1932.17461
0.75	3/4"	–	–	1925.19051	1932.19051
0.8125	13/16"	–	–	1925.20631	1932.20631
0.875	7/8"	–	–	–	1932.22221
0.9375	15/16"	–	–	–	1932.23811
1.0	1"	–	–	–	1932.25401

For further technical information, please refer to page 301

Expert advice

The outer diameter of the reduction sleeves corresponds to each type, e.g. HS 12 equals diameter 12 mm.

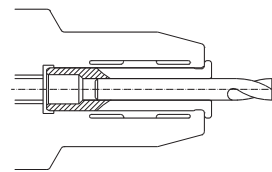

HS section drawing

Ø bore		Part no.			
[decimal "]	[inch]	HS 1/2"	HS 3/4"	HS 1"	HS 1 1/4"
0.125	1/8"	1913.03182	1919.03182	1926.03182	–
0.1875	3/16"	1913.04762	1919.04762	1926.04762	1931.04762
0.25	1/4"	1913.06352	1919.06352	1926.06352	1931.06352
0.3125	5/16"	1913.07942	1919.07942	1926.07942	1931.07942
0.375	3/8"	1913.09522	1919.09522	1926.09522	1931.09522
0.4375	7/16"	–	1919.11112	1926.11112	1931.11112
0.5	1/2"	–	1919.12702	1926.12702	1931.12702
0.5625	9/16"	–	1919.14292	1926.14292	1931.14292
0.625	5/8"	–	1919.15882	1926.15882	1931.15882
0.6875	11/16"	–	–	1926.17462	1931.17462
0.75	3/4"	–	–	1926.19052	1931.19052
0.8125	13/16"	–	–	–	–
0.875	7/8"	–	–	–	–
0.9375	15/16"	–	–	–	–
1.0	1"	–	–	–	1931.25402

For further technical information, please refer to page 301

Expert advice

Our chip cover is ideally suited for the removal of chips. The cover can simply be clicked-in at the head of our reduction sleeves.

For part numbers and more information, please refer to page 236

Expert advice

The coolant flush reductions sleeves HS-CF can be used for peripheral cooling due to their coolant channels.

Easy removing of the reduction sleeve from hydro chucks thanks to the extractor EHS.

For part numbers and more information, please refer to page 236.

Extractors for reduction sleeves EHS

Chip covers for reduction sleeves CC

EHS

CC-HS

Type	Part no.	A [mm]	B [mm]
Extractors for reduction sleeves EHS			
EHS 12 – 1/2"	7321.12000	24	100
EHS 20 – 3/4"	7321.20000	38	160
EHS 25 – 1"	7321.25000	51	180
EHS 32 – 1 1/4"	7321.32000	63	200

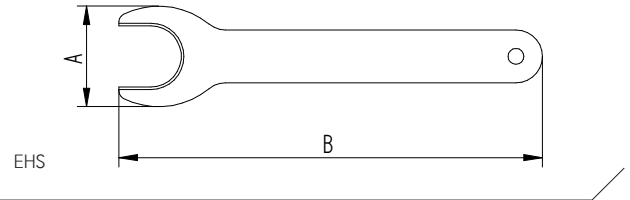

Type	Part no.	Fits	Reduction sleeve Ø	
			[mm]	[inch]
Chip covers for reduction sleeves CC-HS 12				
CC-HS 12 – 1/2" / Ø 4.0 mm	7331.04200	HS 12, HS 1/2"	3–4	1/8"
CC-HS 12 – 1/2" / Ø 6.0 mm	7331.06600	HS 12, HS 1/2"	5–6	3/16"–1/4"
CC-HS 12 – 1/2" / Ø 10.0 mm	7331.10200	HS 12, HS 1/2"	7–10	5/16"–3/8"

Chip covers for reduction sleeves CC-HS 20				
CC-HS 20 – 3/4" / Ø 4.0 mm	7333.04200	HS 20, HS 3/4"	3–4	1/8"
CC-HS 20 – 3/4" / Ø 6.0 mm	7333.06600	HS 20, HS 3/4"	5–6	1/16"–1/4"
CC-HS 20 – 3/4" / Ø 10.0 mm	7333.10200	HS 20, HS 3/4"	7–10	5/16"–3/8"
CC-HS 20 – 3/4" / Ø 14.0 mm	7333.14200	HS 20, HS 3/4"	11–14	7/16"–1/2"
CC-HS 20 – 3/4" / Ø 16.0 mm	7333.16200	HS 20, HS 3/4"	15–16	9/16"–5/8"
CC-HS 20 – 3/4" / Ø 18.0 mm	7333.18200	HS 20, HS 3/4"	18	–

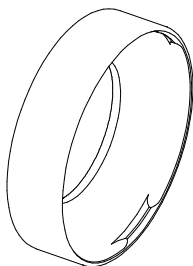

CC-HS

The land of majestic peaks
and powerful toolholders

Achieve toolholding excellence



Accessories

powRgrip® accessories	238
Balancing rings	241
Sealing disks	244
Coolant flush disks	252
Wrenches	255
Torque wrenches	258
Toolholding fixtures	260
Mobile workbench for PGU 9500	261
TORCO-BLOCK	262
Taper cleaner	264
Coolant tubes KSR	265
Trays for collets	266

The colored dots show the system affiliation.
Various products can be used with multiple systems.

- powRgrip® System
- ER System
- micRun® System
- Multi Line System



powRgrip® taper cleaner TKCP

Cleaning paper set CPS

TKCP

CPS

Type	Part no.	Use for
Taper cleaner TKCP		
TKCP 6	7657.06000	PG 6
TKCP 10	7657.10000	PG 10
TKCP 15	7657.15000	PG 15
TKCP 25	7657.25000	PG 25
TKCP 32	7657.32000	PG 32

Includes taper cleaner and cleaning paper set

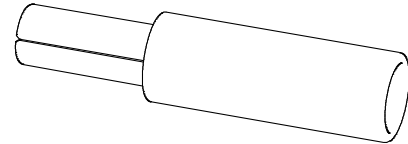

TKCP

Type	Part no.
Cleaning paper set CPS	
CPS 6	7658.06000
CPS 10	7658.10000
CPS 15	7658.15000
CPS 25	7658.25000
CPS 32	7658.32000

Each CPS contains 250 sheets. For single use only

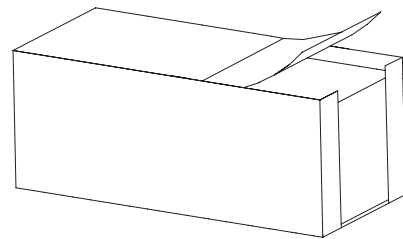

CPS



Type	Part no.	Offset
Length-presetting tool VEW		
VEW 6	7619.06000	80
VEW 10	7619.10000	100
VEW 15	7619.15000	100
VEW 25	7619.25000	100
VEW 32	7619.32000	100

Precise tool adjusting The powRgrip® presetting tool accommodates the powRgrip® collet and is inserted into the toolholder. The presetting tool has an adjustment wheel for precise tool adjustments.

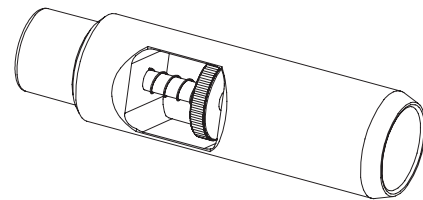
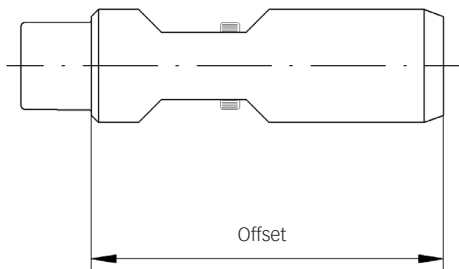

VEW

Length-presetting tool VEW

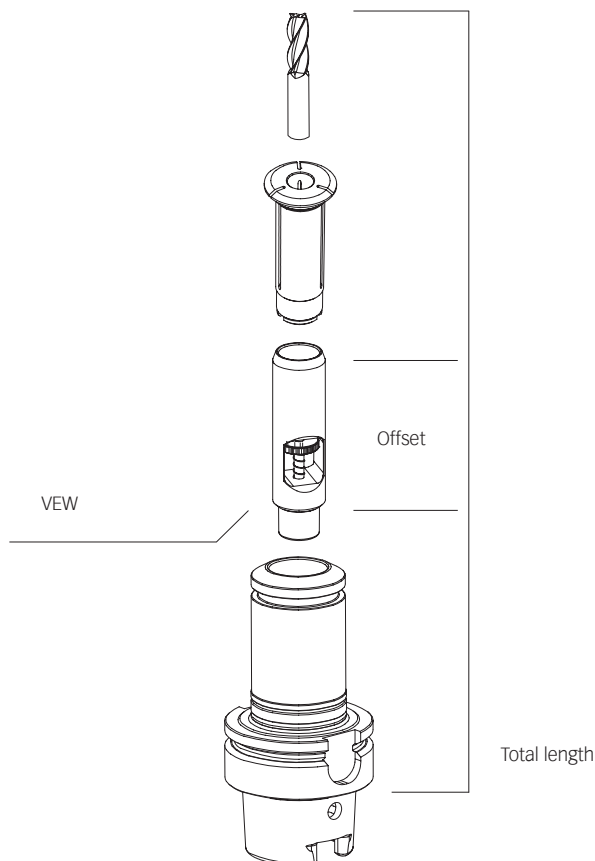

How it works

- // Insert the length-presetting tool VEW into the powRgrip® toolholder
- // Insert the powRgrip® collet into the length presetting tool
- // Insert the cutting tool into the powRgrip® collet
- // Adjust the tool length by turning the adjustment wheel
- // Measure the total length of the cutting tool and subtract the length of the VEW (80 mm / 100 mm) from the total length
- // Remove the length-presetting tool VEW
- // Clamp collet and cutting tool into the powRgrip® toolholder with the powRgrip® clamping unit

Hi-Q® balancing rings FWR Torque screwdriver TSD

FWR

TSD

Type	Part no.	Dimensions [mm]			Balancing capacity [gmm]			max. rpm	System
		D	d	L	FWR SET	single FWR			
Hi-Q® balancing rings FWR									
SET FWR 225	7490.22500	30.5	22.5	6	16	8	80 000	●●	
SET FWR 285	7490.28500	36.5	28.5	6	32	16	70 000	●●	
SET FWR 325	7490.32500	40.5	32.5	6	44	22	60 000	●●	
SET FWR 405	7490.40500	48.5	40.5	6	52	26	50 000	●●	
SET FWR 505	7490.50500	60.5	50.5	7	130	65	42 000	●●	

Included in set: two Hi-Q® balancing rings per set



Balancing rings SET FWR

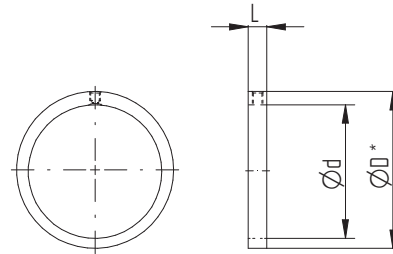

Single balancing ring

*Rotational diameter

Type	Part no.
TSD TORX 8 for balancing rings	
TSD 0.9 Nm	7159.09000

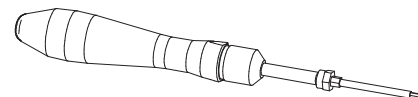

TSD

Expert advice

The torque screwdriver is a special TORX style wrench that is preset to the recommended torque rating of 0.9 Nm for tightening the REGO-FIX Hi-Q® balancing rings.



Effective solution for internal cooling

Our sealing disks allow you to use your regular collet for internal cooling, saving the need for new collets.

Key advantages

Swiss quality product

Sealing range

0.5 mm

ER 11 has no sealing range and can only be used nominally. Assembling with mounting tool MWZ.

High pressure

For applications up to 150 bar / 2100 PSI.

Protection

Protects against all kind of dirt and chips entering the slots of the collet.

Matched tooling system for best fit

Our long-lasting machining experience results in a well-engineered system. All components are fitted together to one system to maximize your machining potential.

Coolant resistant

O-ring for aggressive coolant (VITON®-quality).

Interchangeable

Quick change of sealing disks according to required tool shank diameter.

Coolant through

For better cooling and lubrication. Extends tool life and supports chip removal.

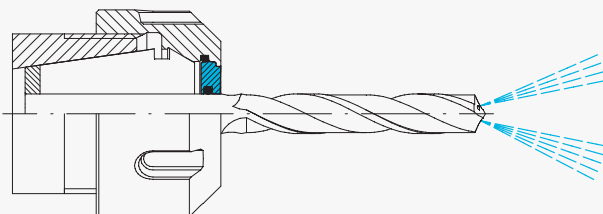
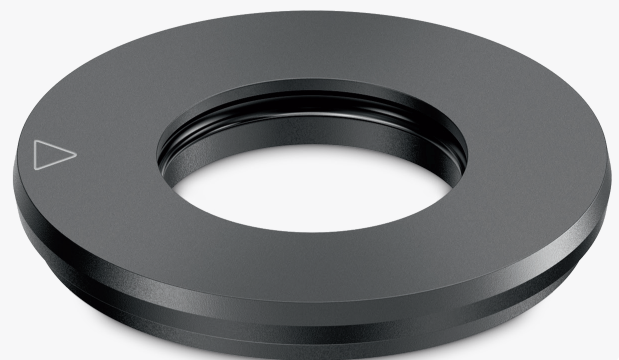

DS/ER

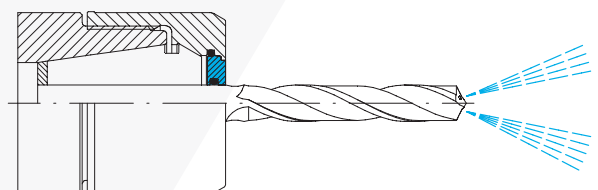

DS/MR

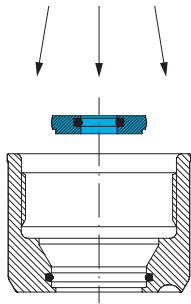

Assembling

Assembling Insert the small diameter of the disk into the center of the coolant nut. Apply an even pressure until the disk is properly seated into the nut.

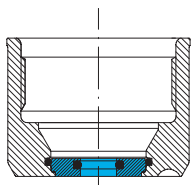

Inserted DS

Removing To remove the disk, simply press on the outside of the disk evenly until it snaps out.

Expert advice

Insert tool with the shank side first. O-ring might be damaged if cutting tool is inserted from the back with the cutting edge side.

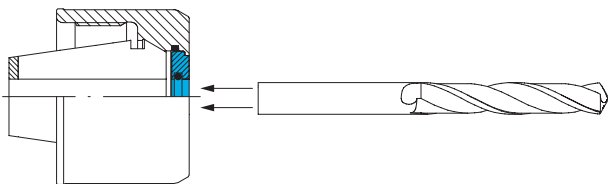

Insert tool

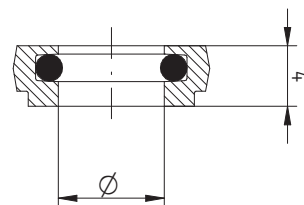

DS/ER

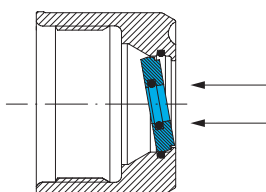

Disk removal

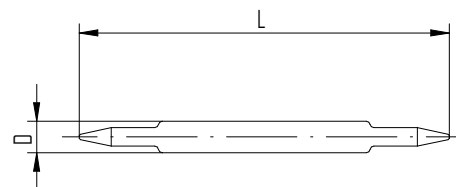

MWZ 11

Type	Part no.	D [mm]	L [mm]
MWZ 11 mounting tool for sealing disks			
MWZ 11	3911.88888	12	140



Sealing disks for ER/MR

DS/ER

DS/MR

Type	Part no.	Tool diameter			Incl. in set	System
		Ø [inch]	[mm]	[decimal inch]		
DS/ER 11						
Ø 3.0 mm	3911.00300	–	3.0	–	–	•
Ø 1/8"	3911.00318	1/8"	–	–	–	•
Ø 4.0 mm	3911.00400	5/32"	4.0	–	–	•
Ø 3/16"	3911.00476	3/16"	–	–	–	•
Ø 5.0 mm	3911.00500	–	5.0	–	–	•
Ø 6.0 mm	3911.00600	–	6.0	–	–	•
Ø 1/4"	3911.00635	1/4"	–	–	–	•
BLANK DS/ER 11	3911.09999	–	–	–	–	•

ER 11 has no sealing range and can only be used nominally. Assembling with mounting tool MWZ.

DS/ER 16						
DS/ER 16 SET (14 pcs.)	3916.00000	–	3.0–10.0	0.1378–0.3937	–	••
Ø 3.0 mm	3916.00300	3/32"	3.0–2.5	0.1181–0.0984	–	••
Ø 3.5 mm	3916.00350	1/8"	3.5–3.0	0.1378–0.1181	•	••
Ø 4.0 mm	3916.00400	5/32"	4.0–3.5	0.1575–0.1378	•	••
Ø 4.5 mm	3916.00450	–	4.5–4.0	0.1772–0.1575	•	••
Ø 5.0 mm	3916.00500	3/16"	5.0–4.5	0.1969–0.1772	•	••
Ø 5.5 mm	3916.00550	7/32"	5.5–5.0	0.2165–0.1969	•	••
Ø 6.0 mm	3916.00600	–	6.0–5.5	0.2362–0.2165	•	••
Ø 6.5 mm	3916.00650	1/4"	6.5–6.0	0.2559–0.2362	•	••
Ø 7.0 mm	3916.00700	–	7.0–6.5	0.2756–0.2559	•	••
Ø 7.5 mm	3916.00750	9/32"	7.5–7.0	0.2953–0.2756	•	••
Ø 8.0 mm	3916.00800	5/16"	8.0–7.5	0.315–0.2953	•	••
Ø 8.5 mm	3916.00850	–	8.5–8.0	0.3346–0.315	•	••
Ø 9.0 mm	3916.00900	11/32"	9.0–8.5	0.3543–0.3346	•	••
Ø 9.5 mm	3916.00950	3/8"	9.5–9.0	0.374–0.3543	•	••
Ø 10.0 mm	3916.01000	–	10.0–9.5	0.3937–0.374	•	••
BLANK DS/ER 16	3916.09999	–	–	–	–	••

Included in the DS/ER sets are all marked disks within that ER size and the matching disk try DSR

DS/ER 20						
SET DS/ER 20 (20 pcs.)	3920.00000	–	3.0–13.0	0.1378–0.5118	–	•
Ø 3.0 mm	3920.00300	3/32"	3.0–2.5	0.1181–0.0984	–	•
Ø 3.5 mm	3920.00350	1/8"	3.5–3.0	0.1378–0.1181	•	•
Ø 4.0 mm	3920.00400	5/32"	4.0–3.5	0.1575–0.1378	•	•
Ø 4.5 mm	3920.00450	–	4.5–4.0	0.2165–0.1969	•	•
Ø 5.0 mm	3920.00500	3/16"	5.0–4.5	0.1969–0.1772	•	•
Ø 5.5 mm	3920.00550	7/32"	5.5–5.0	0.1772–0.1575	•	•
Ø 6.0 mm	3920.00600	–	6.0–5.5	0.2362–0.2165	•	•
Ø 6.5 mm	3920.00650	1/4"	6.5–6.0	0.2559–0.2362	•	•
Ø 7.0 mm	3920.00700	–	7.0–6.5	0.2756–0.2559	•	•
Ø 7.5 mm	3920.00750	9/32"	7.5–7.0	0.2953–0.2756	•	•
Ø 8.0 mm	3920.00800	5/16"	8.0–7.5	0.315–0.2953	•	•
Ø 8.5 mm	3920.00850	–	8.5–8.0	0.3346–0.315	•	•

Sealing disks for ER/MR

DS/ER

DS/MR

Type	Part no.	Tool diameter			Incl. in set	System
		Ø [inch]	[mm]	[decimal inch]		
Ø 9.0 mm	3920.00900	11/32"	9.0–8.5	0.3543–0.3346	•	•
Ø 9.5 mm	3920.00950	3/8"	9.5–9.0	0.374–0.3543	•	•
Ø 10.0 mm	3920.01000	–	10.0–9.5	0.3937–0.374	•	•
Ø 10.5 mm	3920.01050	13/32"	10.5–10.0	0.4134–0.3937	•	•
Ø 11.0 mm	3920.01100	–	11.0–10.5	0.433–0.4134	•	•
Ø 11.5 mm	3920.01150	7/16"	11.5–11.0	0.4528–0.4331	•	•
Ø 12.0 mm	3920.01200	15/32"	12.0–11.5	0.4724–0.4528	•	•
Ø 12.5 mm	3920.01250	–	12.5–12.0	0.4921–0.4724	•	•
Ø 13.0 mm	3920.01300	1/2"	13.0–12.5	0.5118–0.4921	•	•
BLANK DS/ER 20	3920.09999	–	–	–	–	•

Included in the DS/ER sets are all marked disks within that ER size and the matching disk try DSR

DS/ER 25

SET DS/ER 25 (26 pcs.)	3925.00000	–	3.0–16.0	0.1181–0.6299	–	••
Ø 3.0 mm	3925.00300	3/32"	3.0–2.5	0.1181–0.0984	–	••
Ø 3.5 mm	3925.00350	1/8"	3.5–3.0	0.1378–0.1181	•	••
Ø 4.0 mm	3925.00400	5/32"	4.0–3.5	0.1575–0.1378	•	••
Ø 4.5 mm	3925.00450	–	4.5–4.0	0.1772–0.1575	•	••
Ø 5.0 mm	3925.00500	3/16"	5.0–4.5	0.1969–0.1772	•	••
Ø 5.5 mm	3925.00550	7/32"	5.5–5.0	0.2165–0.1969	•	••
Ø 6.0 mm	3925.00600	–	6.0–5.5	0.2362–0.2165	•	••
Ø 6.5 mm	3925.00650	1/4"	6.5–6.0	0.2559–0.2362	•	••
Ø 7.0 mm	3925.00700	–	7.0–6.5	0.2756–0.2559	•	••
Ø 7.5 mm	3925.00750	9/32"	7.5–7.0	0.2953–0.2756	•	••
Ø 8.0 mm	3925.00800	5/16"	8.0–7.5	0.315–0.2953	•	••
Ø 8.5 mm	3925.00850	–	8.5–8.0	0.3346–0.315	•	••
Ø 9.0 mm	3925.00900	11/32"	9.0–8.5	0.3543–0.3347	•	••
Ø 9.5 mm	3925.00950	3/8"	9.5–9.0	0.374–0.3543	•	••
Ø 10.0 mm	3925.01000	–	10.0–9.5	0.3937–0.374	•	••
Ø 10.5 mm	3925.01050	13/32"	10.5–10.0	0.4134–0.3937	•	••
Ø 11.0 mm	3925.01100	–	11.0–10.5	0.433–0.4134	•	••
Ø 11.5 mm	3925.01150	7/16"	11.5–11.0	0.4528–0.433	•	••
Ø 12.0 mm	3925.01200	15/32"	12.0–11.5	0.4724–0.4528	•	••
Ø 12.5 mm	3925.01250	–	12.5–12.0	0.4921–0.4724	•	••
Ø 13.0 mm	3925.01300	1/2"	13.0–12.5	0.2118–0.4921	•	••
Ø 13.5 mm	3925.01350	17/32"	13.5–13.0	0.5315–0.5118	•	••
Ø 14.0 mm	3925.01400	–	14.0–13.5	0.5512–0.5315	•	••
Ø 14.5 mm	3925.01450	9/16"	14.5–14.0	0.5709–0.5512	•	••
Ø 15.0 mm	3925.01500	–	15.0–14.5	0.5906–0.5709	•	••
Ø 15.5 mm	3925.01550	19/32"	15.5–15.0	0.6102–0.5906	•	••
Ø 16.0 mm	3925.01600	5/8"	16.0–15.5	0.6299–0.6102	•	••
BLANK DS/ER 25	3925.09999	–	–	–	–	••

Included in the DS/ER sets are all marked disks within that ER size and the matching disk try DSR



Sealing disks for ER/MR

DS/ER

DS/MR

Type	Part no.	Tool diameter			Incl. in set	System
		Ø [inch]	[mm]	[decimal inch]		
DS/ER 32						
DS/ER 32 SET (34 pcs.)	3932.00000	–	3.0–20.0	0.1181–0.7874	–	••
Ø 3.0 mm	3932.00300	3/32"	3.0–2.5	0.1181–0.0984	–	••
Ø 3.5 mm	3932.00350	1/8"	3.5–3.0	0.1378–0.1181	•	••
Ø 4.0 mm	3932.00400	5/32"	4.0–3.5	0.1575–0.1378	•	••
Ø 4.5 mm	3932.00450	–	4.5–4.0	0.1772–0.1575	•	••
Ø 5.0 mm	3932.00500	3/16"	5.0–4.5	0.1969–0.1772	•	••
Ø 5.5 mm	3932.00550	7/32"	5.5–5.0	0.2165–0.1969	•	••
Ø 6.0 mm	3932.00600	–	6.0–5.5	0.2362–0.2165	•	••
Ø 6.5 mm	3932.00650	1/4"	6.5–6.0	0.2559–0.2362	•	••
Ø 7.0 mm	3932.00700	–	7.0–6.5	0.2756–0.2559	•	••
Ø 7.5 mm	3932.00750	9/32"	7.5–7.0	0.2953–0.2756	•	••
Ø 8.0 mm	3932.00800	5/16"	8.0–7.5	0.315–0.2953	•	••
Ø 8.5 mm	3932.00850	–	8.5–8.0	0.3346–0.315	•	••
Ø 9.0 mm	3932.00900	11/32"	9.0–8.5	0.3543–0.3346	•	••
Ø 9.5 mm	3932.00950	3/8"	9.5–9.0	0.374–0.3543	•	••
Ø 10.0 mm	3932.01000	–	10.0–9.5	0.3937–0.374	•	••
Ø 10.5 mm	3932.01050	13/32"	10.5–10.0	0.4134–0.3937	•	••
Ø 11.0 mm	3932.01100	–	11.0–10.5	0.4331–0.4134	•	••
Ø 11.5 mm	3932.01150	7/16"	11.5–11.0	0.4528–0.4331	•	••
Ø 12.0 mm	3932.01200	15/32"	12.0–11.5	0.4724–0.4528	•	••
Ø 12.5 mm	3932.01250	–	12.5–12.0	0.4921–0.4724	•	••
Ø 13.0 mm	3932.01300	1/2"	13.0–12.5	0.5118–0.4921	•	••
Ø 13.5 mm	3932.01350	17/32"	13.5–13.0	0.5315–0.5118	•	••
Ø 14.0 mm	3932.01400	–	14.0–13.5	0.5512–0.5315	•	••
Ø 14.5 mm	3932.01450	9/16"	14.5–14.0	0.5709–0.5512	•	••
Ø 15.0 mm	3932.01500	–	15.0–14.5	0.5905–0.5709	•	••
Ø 15.5 mm	3932.01550	19/32"	15.5–15.0	0.6102–0.5906	•	••
Ø 16.0 mm	3932.01600	5/8"	16.0–15.5	0.6299–0.6102	•	••
Ø 16.5 mm	3932.01650	–	16.5–16.0	0.6496–0.6299	•	••
Ø 17.0 mm	3932.01700	21/32"	17.0–16.5	0.6693–0.6496	•	••
Ø 17.5 mm	3932.01750	11/16"	17.5–17.0	0.689–0.6693	•	••
Ø 18.0 mm	3932.01800	–	18.0–17.5	0.7087–0.689	•	••
Ø 18.5 mm	3932.01850	23/32"	18.5–18.0	0.7283–0.7087	•	••
Ø 19.0 mm	3932.01900	3/4"	19.0–18.5	0.748–0.7283	•	••
Ø 19.5 mm	3932.01950	–	19.5–19.0	0.7677–0.748	•	••
Ø 20.0 mm	3932.02000	25/32"	20.0–19.5	0.7874–0.7677	•	••
BLANK DS/ER 32	3932.09999	–	–	–	–	••

Included in the DS/ER sets are all marked disks within that ER size and the matching disk try DSR

Sealing disks for ER

DS/ER

Type	Part no.	Tool diameter			Incl. in set	System
		Ø [inch]	[mm]	[decimal inch]		
DS/ER 40						
DS/ER 40 SET (46 pcs.)	3940.00000	–	3.0–26.0	0.1181–1.0236	–	•
Ø 3.0 mm	3940.00300	3/32"	3.0–2.5	0.1181–0.0984	–	•
Ø 3.5 mm	3940.00350	1/8"	3.5–3.0	0.1378–0.1181	•	•
Ø 4.0 mm	3940.00400	5/32"	4.0–3.5	0.1575–0.1378	•	•
Ø 4.5 mm	3940.00450	–	4.5–4.0	0.1772–0.1575	•	•
Ø 5.0 mm	3940.00500	3/16"	5.0–4.5	0.1969–0.1772	•	•
Ø 5.5 mm	3940.00550	7/32"	5.5–5.0	0.2165–0.1969	•	•
Ø 6.0 mm	3940.00600	–	6.0–5.5	0.2362–0.2165	•	•
Ø 6.5 mm	3940.00650	1/4"	6.5–6.0	0.2559–0.2362	•	•
Ø 7.0 mm	3940.00700	–	7.0–6.5	0.2756–0.2559	•	•
Ø 7.5 mm	3940.00750	9/32"	7.5–7.0	0.2953–0.2756	•	•
Ø 8.0 mm	3940.00800	5/16"	8.0–7.5	0.315–0.2953	•	•
Ø 8.5 mm	3940.00850	–	8.5–8.0	0.3347–0.315	•	•
Ø 9.0 mm	3940.00900	11/32"	9.0–8.5	0.3543–0.3347	•	•
Ø 9.5 mm	3940.00950	3/8"	9.5–9.0	0.374–0.3543	•	•
Ø 10.0 mm	3940.01000	–	10.0–9.5	0.3937–0.374	•	•
Ø 10.5 mm	3940.01050	13/32"	10.5–10.0	0.4134–0.3937	•	•
Ø 11.0 mm	3940.01100	–	11.0–10.5	0.433–0.4134	•	•
Ø 11.5 mm	3940.01150	7/16"	11.5–11.0	0.4528–0.433	•	•
Ø 12.0 mm	3940.01200	15/32"	12.0–11.5	0.4724–0.4528	•	•
Ø 12.5 mm	3940.01250	–	12.5–12.0	0.4921–0.4724	•	•
Ø 13.0 mm	3940.01300	1/2"	13.0–12.5	0.5118–0.4921	•	•
Ø 13.5 mm	3940.01350	17/32"	13.5–13.0	0.5315–0.5118	•	•
Ø 14.0 mm	3940.01400	–	14.0–13.5	0.5512–0.5315	•	•
Ø 14.5 mm	3940.01450	9/16"	14.5–14.0	0.5709–0.5512	•	•
Ø 15.0 mm	3940.01500	–	15.0–14.5	0.5905–0.5709	•	•
Ø 15.5 mm	3940.01550	19/32"	15.5–15.0	0.6102–0.5905	•	•
Ø 16.0 mm	3940.01600	5/8"	16.0–15.5	0.6299–0.6102	•	•
Ø 16.5 mm	3940.01650	–	16.5–16.0	0.6496–0.6299	•	•
Ø 17.0 mm	3940.01700	21/32"	17.0–16.5	0.6693–0.6496	•	•
Ø 17.5 mm	3940.01750	11/16"	17.5–17.0	0.689–0.6693	•	•
Ø 18.0 mm	3940.01800	–	18.0–17.5	0.7087–0.689	•	•
Ø 18.5 mm	3940.01850	23/32"	18.5–18.0	0.7283–0.7087	•	•
Ø 19.0 mm	3940.01900	3/4"	19.0–18.5	0.748–0.7283	•	•
Ø 19.5 mm	3940.01950	–	19.5–19.0	0.7677–0.748	•	•
Ø 20.0 mm	3940.02000	23/32"	20.0–19.5	0.7874–0.7677	•	•
Ø 20.5 mm	3940.02050	–	20.5–20.0	0.8071–0.7874	•	•
Ø 21.0 mm	3940.02100	13/16"	21.0–20.5	0.8268–0.8071	•	•
Ø 21.5 mm	3940.02150	25/32"	21.5–21.0	0.8465–0.8268	•	•



Type	Part no.	Tool diameter			Incl. in set	System
		Ø [inch]	[mm]	[decimal inch]		
Ø 22.0 mm	3940.02200	–	22.0–21.5	0.8661–0.8465	•	•
Ø 22.5 mm	3940.02250	7/8"	22.5–22.0	0.8858–0.8268	•	•
Ø 23.0 mm	3940.02300	29/32"	23.0–22.5	0.9055–0.8858	•	•
Ø 23.5 mm	3940.02350	–	23.5–23.0	0.9252–0.9055	•	•
Ø 24.0 mm	3940.02400	15/16"	24.0–23.5	0.9449–0.9252	•	•
Ø 24.5 mm	3940.02450	–	24.5–24.0	0.9646–0.9449	•	•
Ø 25.0 mm	3940.02500	31/32"	25.0–24.5	0.9843–0.9646	•	•
Ø 25.5 mm	3940.02550	1"	25.5–25.0	1.0039–0.9843	•	•
Ø 26.0 mm	3940.02600	–	26.0–25.5	1.0236–1.0039	•	•
BLANK DS/ER 40	3940.09999	–	–	–	–	•

Included in the DS/ER sets are all marked disks within that ER size and the matching disk try DSR

DS/ER 50

ADP ER 50–DS/ER 40*	3950.40000	–	3.0–26.0	0.1181–1.0236	–	•
Ø 22.0 mm	3950.02200	–	22.0–21.5	0.8661–0.8465	–	•
Ø 25.0 mm	3950.02500	–	25.0–24.5	0.9842–0.9645	–	•
Ø 28.0 mm	3950.02800	–	28.0–27.5	1.1023–1.0827	–	•
Ø 32.0 mm	3950.03200	–	32.0–31.5	1.2598–1.2402	–	•
Ø 36.0 mm	3950.03600	–	36.0–35.5	1.4173–1.3976	–	•

*The ADP ER 50-DS/ER 40 only works in combination with a sealing disk DS/ER 40. DS/ER 40 is not included in delivery

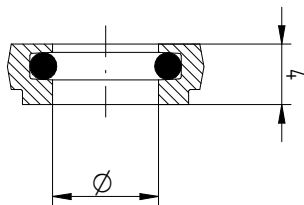

DS/ER

Expert advice

The BLANK DS/ER is used as machining blank for specific sizes or as sealing disk for double-sided driven tools.

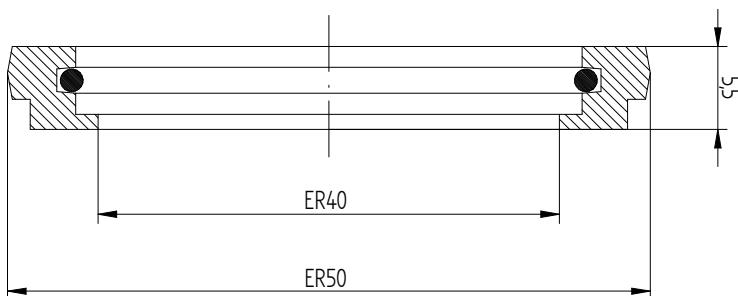

ADP ER 50–DS/ER 40

Expert advice

The adapter ADP ER 50–DS/ER 40 allows the use of DS/ER-40 sealing disks in ER-50 clamping nuts.



Our solution for peripheral cooling

The design of our coolant flush disks leads the coolant along the edge of the cutting tool, providing you with an easy way to achieve peripheral cooling.

Key advantages

Swiss quality product

Universal use

For all REGO-FIX collets and coolant nuts with interchangeable disk.

Interchangeable

Quick change of coolant flush disks according to required tool shank diameter.

Peripheral cooling

For better cooling and lubrication.
Extends tool life and supports chip removal.

Original REGO-FIX

Our long-lasting machining experience results in a well-engineered system. When buying ER coolant flush disks please pay attention to the REGO-FIX quality seal on the coolant flush disk: The triangle is our seal for outstanding quality made in Switzerland.

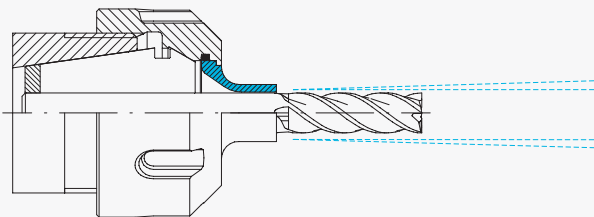

KS/ER

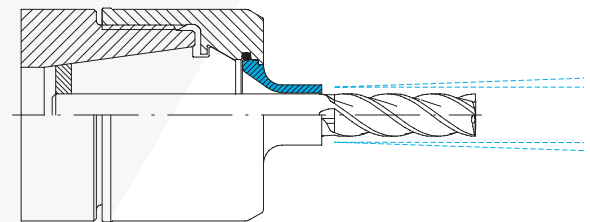

KS/MR

Coolant flush disks for ER/MR

KS/ER
KS/MR

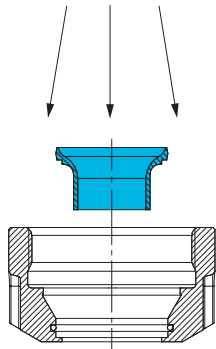

Assembling

Assembling Insert the small diameter of the disk into the center of the coolant nut. Apply an even pressure until the disk is properly seated into the nut.

The disk must be flush with the outside of the nut and the marking on the disk must be visible inside of the nut.

Removing To remove the disk, simply press on the outside of the disk evenly until it snaps out.

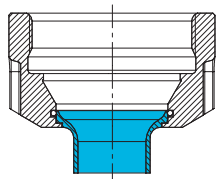

Inserted KS/ER

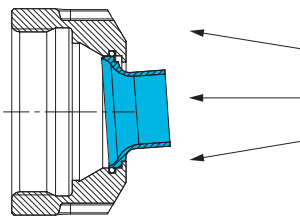

Removing



Coolant flush disks for ER/MR

KS/ER
DS/MR

Type	Part no.	Dimensions [mm]		Ø		System
		D	L	[mm]	[inch]	
KS/ER 11 [mm]/[inch]						
Ø 3.0 mm / 1/8"	3911.30318	5.6	5.5	3	1/8"	●
Ø 4.0 mm	3911.20400	6.4	5.5	4	–	●
Ø 5.0 mm / 3/16"	3911.20500	7.5	5.5	5	3/16"	●
Ø 6.0 mm / 1/4"	3911.30635	7.5	5.5	6	1/4"	●
BLANK KS/ER 11 Ø 7.5 x 8	3911.29999	7.5	8	–	–	●
KS/ER 16 [mm]						
Ø 3.0 mm	3916.20300	6.4	11	3	–	●●
Ø 4.0 mm	3916.20400	7.4	11	4	–	●●
Ø 5.0 mm	3916.20500	8.4	11	5	–	●●
Ø 6.0 mm	3916.20600	9.4	11	6	–	●●
Ø 7.0 mm	3916.20700	11	11	7	–	●●
Ø 8.0 mm	3916.20800	11	11	8	–	●●
Ø 9.0 mm	3916.20900	11	2	9	–	●●
Ø 10.0 mm	3916.21000	11	2	10	–	●●
BLANK KS/ER 16 Ø 11 x 12*	3916.29999	11	12	–	–	●●
KS/ER 16 [inch]						
Ø 1/8"	3916.30318	6.6	11	3.175	1/8"	●●
Ø 3/16"	3916.30476	8.2	11	4.763	3/16"	●●
Ø 1/4"	3916.30635	9.7	11	6.35	1/4"	●●
Ø 5/16"	3916.30794	11	11	7.938	5/16"	●●
Ø 3/8"	3916.30953	11	2	9.525	3/8"	●●
KS/ER 20 [mm]						
Ø 3.0 mm	3920.20300	6.4	11	3	–	●
Ø 4.0 mm	3920.20400	7.4	11	4	–	●
Ø 5.0 mm	3920.20500	8.4	11	5	–	●
Ø 6.0 mm	3920.20600	9.4	11	6	–	●
Ø 7.0 mm	3920.20700	10.4	11	7	–	●
Ø 8.0 mm	3920.20800	11.4	11	8	–	●
Ø 9.0 mm	3920.20900	12.4	11	9	–	●
Ø 10.0 mm	3920.21000	14	11	10	–	●
Ø 12.0 mm	3920.21200	14	3	12	–	●
BLANK KS/ER 20 Ø 14 x 12*	3920.29999	14	12	–	–	●

*Work material: 42CrMoS4 (1.7227)

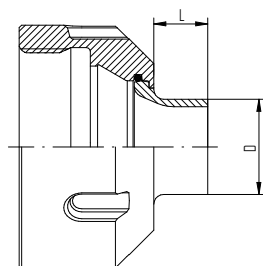

KS/ER

Coolant flush disks for ER/MR

KS/ER

DS/MR

Type	Part no.	Dimensions [mm]		Ø		System
		D	L	[mm]	[inch]	
KS/ER 20 [inch]						
Ø 1/8"	3920.30318	6.6	11	3.175	1/8"	●
Ø 3/16"	3920.30476	8.2	11	4.763	3/16"	●
Ø 1/4"	3920.30635	9.7	11	6.35	1/4"	●
Ø 5/16"	3920.30794	11.3	11	7.983	5/16"	●
Ø 3/8"	3920.30953	14	11	9.525	3/8"	●
Ø 7/16"	3920.31111	14	11	11.113	7/16"	●
Ø 1/2"	3920.31270	14	3	12.7	1/2"	●

KS/ER 25 [mm]						
Ø 3.0 mm	3925.20300	6.4	11	3	-	●●
Ø 4.0 mm	3925.20400	7.4	11	4	-	●●
Ø 5.0 mm	3925.20500	8.4	11	5	-	●●
Ø 6.0 mm	3925.20600	9.4	11	6	-	●●
Ø 7.0 mm	3925.20700	10.4	11	7	-	●●
Ø 8.0 mm	3925.20800	11.4	11	8	-	●●
Ø 9.0 mm	3925.20900	12.4	11	9	-	●●
Ø 10.0 mm	3925.21000	13.4	11	10	-	●●
Ø 12.0 mm	3925.21200	15.4	11	12	-	●●
Ø 14.0 mm	3925.21400	17.4	11	14	-	●●
Ø 16.0 mm	3925.21600	19	11	16	-	●●
BLANK KS/ER 25 Ø 19 x 12*	3925.29999	19	12	-	-	●●

KS/ER 25 [inch]						
Ø 1/8"	3925.30318	6.6	11	3.175	1/8"	●●
Ø 3/16"	3925.30476	8.2	11	4.763	3/16"	●●
Ø 1/4"	3925.30635	9.7	11	6.35	1/4"	●●
Ø 5/16"	3925.30794	11.3	11	7.938	5/16"	●●
Ø 3/8"	3925.30953	12.9	11	9.525	3/8"	●●
Ø 7/16"	3925.31111	14.5	11	11.113	7/16"	●●
Ø 1/2"	3925.31270	16.1	11	12.7	1/2"	●●
Ø 9/16"	3925.31429	17.7	11	14.288	9/16"	●●
Ø 5/8"	3925.31588	19	11	15.875	5/8"	●●

*Work material: 42CrMoS4 (1.7227)



Coolant flush disks for ER/MR

KS/ER
KS/MR

Type	Part no.	Dimensions [mm]		Ø		System
		D	L	[mm]	[inch]	
KS/ER 32 [mm]						
Ø 3.0 mm	3932.20300	6.4	11	3	–	●●
Ø 4.0 mm	3932.20400	7.4	11	4	–	●●
Ø 5.0 mm	3932.20500	8.4	11	5	–	●●
Ø 6.0 mm	3932.20600	9.4	11	6	–	●●
Ø 7.0 mm	3932.20700	10.4	11	7	–	●●
Ø 8.0 mm	3932.20800	11.4	11	8	–	●●
Ø 9.0 mm	3932.20900	12.4	11	9	–	●●
Ø 10.0 mm	3932.21000	13.4	11	10	–	●●
Ø 12.0 mm	3932.21200	15.4	11	12	–	●●
Ø 14.0 mm	3932.21400	17.4	11	14	–	●●
Ø 16.0 mm	3932.21600	19.4	11	16	–	●●
Ø 18.0 mm	3932.21800	21.4	11	18	–	●●
Ø 20.0 mm	3932.22000	24	11	20	–	●●
BLANK KS/ER 32 Ø 24 x 12*	3932.29999	24	12	–	–	●●

KS/ER 32 [inch]						
Ø 1/8"	3932.30318	6.6	11	3.175	1/8"	●●
Ø 3/16"	3932.30476	8.2	11	4.763	3/16"	●●
Ø 1/4"	3932.30635	9.7	11	6.35	1/4"	●●
Ø 5/16"	3932.30794	11.3	11	7.938	5/16"	●●
Ø 3/8"	3932.30953	12.9	11	9.525	3/8"	●●
Ø 7/16"	3932.31111	14.5	11	11.113	7/16"	●●
Ø 1/2"	3932.31270	16.1	11	12.7	1/2"	●●
Ø 9/16"	3932.31429	17.7	11	14.288	9/16"	●●
Ø 5/8"	3932.31588	19.3	11	15.875	5/8"	●●
Ø 3/4"	3932.31905	24	11	19.05	3/4"	●●

*Work material: 42CrMoS4 (1.7227).

KS/ER 40						
ADP ER 40 KS/ER 32	3940.32000	–	–	3-20	1/8" - 3/4"	●

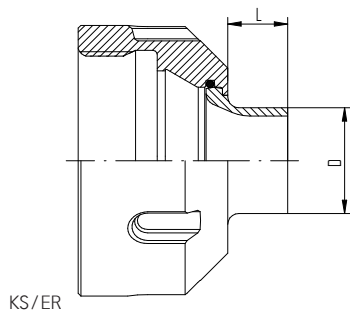

Wrenches

E MS

E AX

E A

Type	Part no.	A [mm]	B [mm]	Suited wrench for Hi-Q®			System
				ER MS	ERAX	ERAXC	
E MS							
E 8 MS	7114.08000	19	76	•	–	–	•
E 11 MS	7114.11000	22	100	•	–	–	•
E 16 MS	7114.16000	33	130	•	–	–	•
E 20 MS	7114.20000	42	140	•	–	–	•
E AX							
E 11 AX	7117.11000	16	108	–	•	–	•
E 16 AX	7117.16000	22	131	–	•	•	•
E 20 AX	7117.20000	26	148	–	•	•	•
E 25 AX	7117.25000	30	165	–	•	•	•
E 32 AX	7117.32000	37	196	–	•	•	•
E 40 AX	7117.40000	47	220	–	•	•	•
Ø [mm]							
E A							
E 11 A	7115.11000	18.6	96	–	–	–	3
E 16 A	7115.16000	25	108	–	–	–	3
E 20 A	7115.20000	28	123	–	–	–	3
E 25 A	7115.25000	30.5	139	–	–	–	4
E 32 A	7115.32000	42	182	–	–	–	4

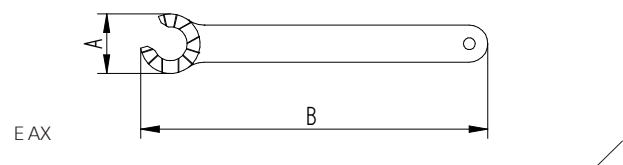
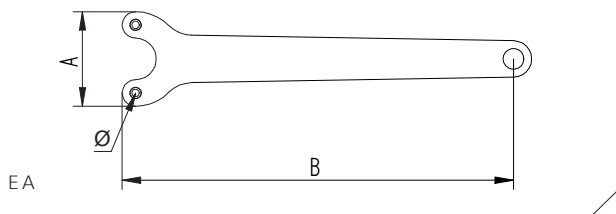
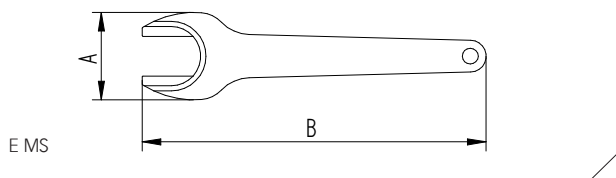

Wrenches

- E
- E P
- E M
- E MX

Suited wrench for Hi-Q®

Type	Part no.	A [mm]	B [mm]	SW [mm]	ER	ERC	ERB	ERBC	ERMC	ERMX	ERMXC	System
E												
E 16	7111.16000	55	163		-	-	-	-	-	-	-	•
E 20	7111.20000	60	183		-	-	-	-	-	-	-	•
E 25	7111.25000	70	203		•	•	•	•	-	-	-	•
E 32	7111.32000	80	253		•	•	•	•	-	-	-	•
E 40	7111.40000	96	283		•	•	•	•	-	-	-	•
E 50	7111.50000	111	350		•	-	•	-	-	-	-	•
E P												
E 11 P	7112.11010	32	95	19	•	•	-	-	-	-	-	•
E 16 P	7112.16010	44	145	28	•	•	•	•	-	-	-	•
E 20 P	7112.20010	52	170	34	•	•	•	•	-	-	-	•
E M												
E 8 M	7113.08000	12	74		-	-	-	-	-	-	-	•
E 11 M	7113.11000	17	95		-	-	-	-	•	-	-	•
E 16 M	7113.16000	22	117		-	-	-	-	•	-	-	•
E 20 M	7113.20000	29	129		-	-	-	-	•	-	-	•
E 25 M	7113.25000	36	141		-	-	-	-	•	-	-	•
E MX												
E 8 MX	7118.08000	12	74		-	-	-	-	-	•	-	•
E 11 MX	7118.11000	17	95		-	-	-	-	-	•	•	•
E 16 MX	7118.16000	22.5	117		-	-	-	-	-	•	•	•
E 20 MX	7118.20000	29	129		-	-	-	-	-	•	•	•
E 25 MX	7118.25000	36	141		-	-	-	-	-	•	•	•

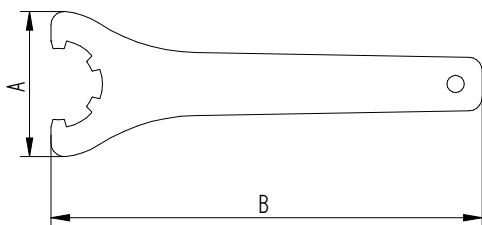

E

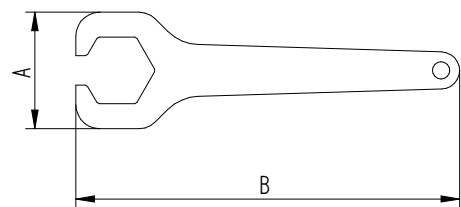

E P

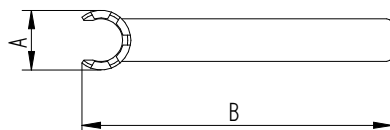

E M

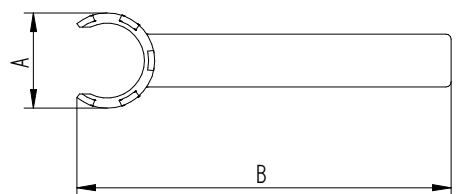

E MX

Wrench heads

A-E

A-E P

A-E M

A-E MX

A-E MS

A-E AX

Type	Part no.	A [mm]	B [mm]	SW [mm]	
A-E					
A-E 16	7151.16000	55	62		•
A-E 20	7151.20000	60	62		•
A-E 25	7151.25000	70	72		•
A-E 32	7151.32000	80	72		•
A-E 40	7151.40000	96	82		•
A-E 50	7151.50000	111	94		•

A-E P					
A-E 11 P	7152.11010	32	57	19	•
A-E 16 P	7152.16010	44	70	28	•
A-E 20 P	7152.20010	52	80	34	•

A-E M					
A-E 8 M	7153.08000	12	53		•
A-E 11 M	7153.11000	17	54		•
A-E 16 M	7153.16000	22	56		•
A-E 20 M	7153.20000	29	68		•
A-E 25 M	7153.25000	36	70		•

A-E MX					
A-E 8 MX	7158.08000	12	53		•
A-E 11 MX	7158.11000	17	54		•
A-E 16 MX	7158.16000	22	56		•
A-E 20 MX	7158.20000	29	68		•
A-E 25 MX	7158.25000	36	70		•

A-E MS					
A-E 8 MS	7154.08000	19	51		•
A-E 11 MS	7154.11000	22	57		•
A-E 16 MS	7154.16000	33	60		•
A-E 20 MS	7154.20000	42	73		•

A-E AX					
A-E 11 AX	7157.11000	16	62		•
A-E 16 AX	7157.16000	22	63		•
A-E 20 AX	7157.20000	26	64		•
A-E 25 AX	7157.25000	29	93		•
A-E 32 AX	7157.32000	37	95		•
A-E 40 AX	7157.40000	47	99		•

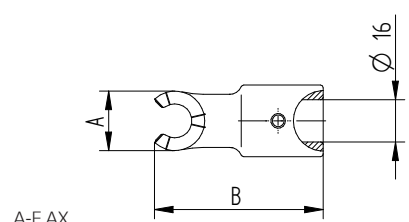
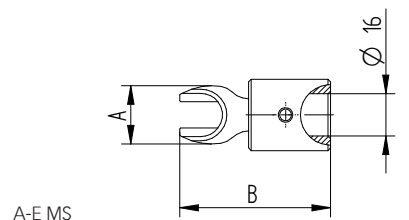
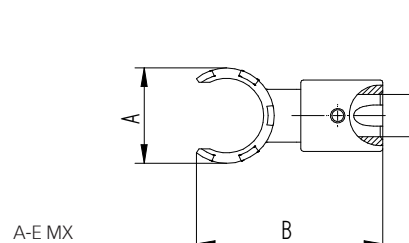
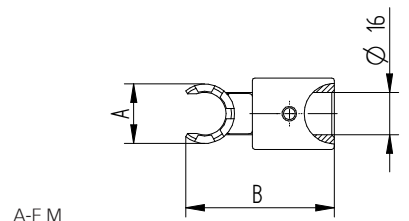
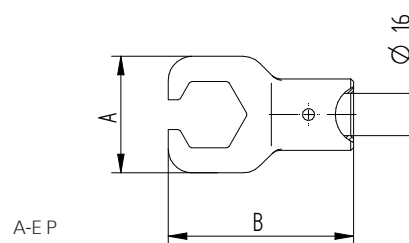
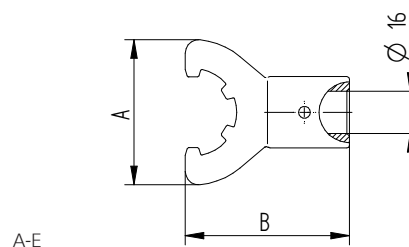

Torque wrenches TORCO-FIX Freewheel wrench heads A-FLS Grip bar for wrench heads G-A

TORCO-FIX

A-FLS

G-A

Type	Part no.	L1 [mm]	Range [Nm]	Range [ft-lbs]	System
TORCO-FIX					
TORCO-FIX 0	7150.02025	290	5–25	3.5–18	●●
TORCO-FIX I	7150.05050	335	10–50	7.5–36.5	●●
TORCO-FIX II	7150.20200	465	40–200	26.5–147	●●●
TORCO-FIX III	7150.60300	565	60–300	44.5–221	●●

Type	Part no.	D [mm]	D1 [mm]	System
Freewheel wrench heads A-FLS				
A-FLS Ø 16/MR 11	7855.11000	16	34	●
A-FLS Ø 24/MRM 16	7855.16800	24	47	●
A-FLS Ø 28/MR 16/SG 15	7855.16000	28	47	●●
A-FLS Ø 40/MR 25	7855.25000	40	61	●
A-FLS Ø 46/SG 25	7655.25000	46	68	●
A-FLS Ø 50/MR 32	7855.32000	50	77	●
A-FLS Ø 55/SG 32	7655.32000	55	77	●

Type	Part no.	L1 [mm]	System
Grip bar for wrench heads G-A			
G-A	7655.99900	308	●●●
G-AS	7655.99500	120	●

Expert advice

Grip bar short G-AS is specially designed to be used with:
A-FLS Ø 16/MR 11
A-FLS Ø 24/MRM 16
A-FLS Ø 28/MR 16

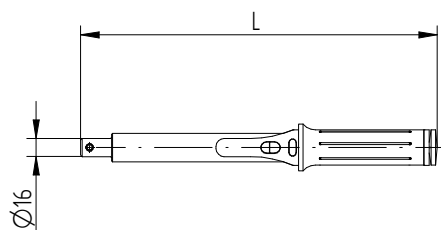

TORCO-FIX

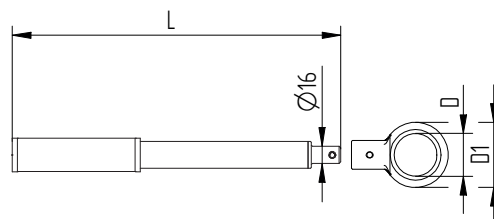

G-A/G-AS with A-FLS

Slip-off proof extension V-E AX for E AX and A-E AX Slip-off proof extension V-E MX for E MX and A-E MX Wrenches for universal shell / face mill holders FDS

V-E AX
V-E MX
FDS

Type	Part no.	D [mm]	L [mm]	Square □		System
				[mm]	[inch]	
V-E AX						
V-E 11 AX	7155.11000	16.5	60	6.35	1/4"	●
V-E 16 AX	7155.16000	22.5	80	6.35	1/4"	●
V-E 20 AX	7155.20000	26	95	9.525	3/8"	●
V-E 25 AX	7155.25000	29.5	105	12.7	1/2"	●
V-E 32 AX	7155.32000	37.5	115	12.7	1/2"	●

Type	Part no.	D [mm]	L [mm]	Square □		System
				[mm]	[inch]	
V-E MX						
V-E 8 MX	7159.08000	17	60	6.35	1/4"	●
V-E 11 MX	7159.11000	17	60	6.35	1/4"	●
V-E 16 MX	7159.16000	22.5	80	6.35	1/4"	●
V-E 20 MX	7159.20000	29	95	12.7	1/2"	●
V-E 25 MX	7159.25000	35	105	19.05	3/4"	●

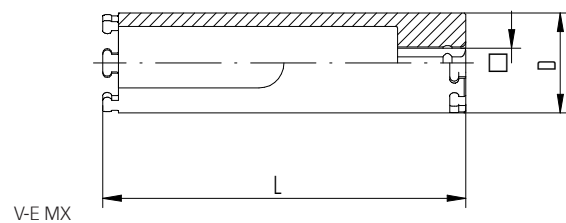
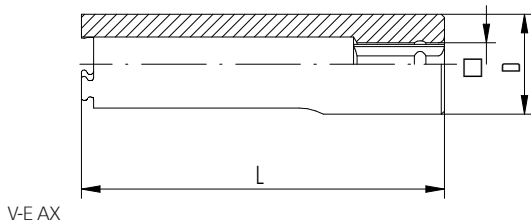

Type	Part no.	System
Wrenches FDS		
FDS 16	7711.16000	●
FDS 22	7711.22000	●
FDS 27	7711.27000	●
FDS 32	7711.32000	●
FDS 40	7711.40000	●
FDS 50	7711.50000	●

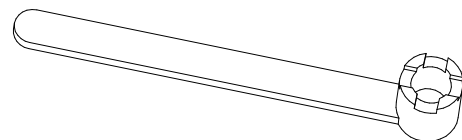

FDS

Toolholding fixtures

- WMH
- WA/SK
- WA/HSK
- WA/C

Type	Part no.	Fits this interface
Tool assembly WMH		
WMH-AC 45°	7813.00000	–
WMH-AC 90°	7813.00100	–

Tool adapter WA/SK		
WA/SK 30	7814.30100	BT/CAT/SK 30
WA/SK 40	7814.40100	BT/CAT/SK 40
WA/SK 50	7814.50100	BT/CAT/SK 50

Tool adapter WA/HSK-A/C/E		
WA/HSK-A/C/E 25	7814.25300	HSK-A/C/E 25

Tool adapter WA/HSK-A		
WA/HSK-A 32	7814.32200	HSK-A 32
WA/HSK-A 40	7814.40200	HSK-A 40
WA/HSK-A 50	7814.50200	HSK-A 50
WA/HSK-A 63	7814.63200	HSK-A 63
WA/HSK-A 80	7814.80200	HSK-A 80
WA/HSK-A 100	7814.00200	HSK-A 100

Tool adapter WA/HSK-C/E		
WA/HSK-C/E 32	7814.32500	HSK-C/E 32
WA/HSK-C/E 40	7814.40500	HSK-C/E 40
WA/HSK-C/E 50	7814.50500	HSK-C/E 50
WA/HSK-C/E 63	7814.63500	HSK-C/E 63

Tool adapter WA/HSK-B/D/F		
WA/HSK-B/D/F 63	7814.63400	HSK-B/D/F 63

Tool adapter WA/C		
WA/C3	7814.03700	CAPTO C3
WA/C4	7814.04700	CAPTO C4
WA/C5	7814.05700	CAPTO C5
WA/C6	7814.06700	CAPTO C6
WA/C8	7814.08700	CAPTO C8

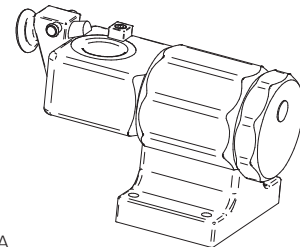

WMH/WA

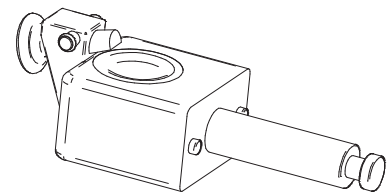

WA

Mobile workbench for PGU 9500

Description Mobile workbench for PGU 9500 with drawer-insert for APG and taper cleaner.

Type	Part no.	Width	Height	Depth
Mobile workbench for PGU 9500				
MWB	7688.00000	750 mm	880 mm	700 mm

Back panel on request

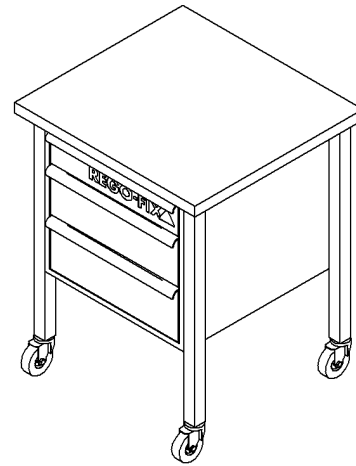

MWB

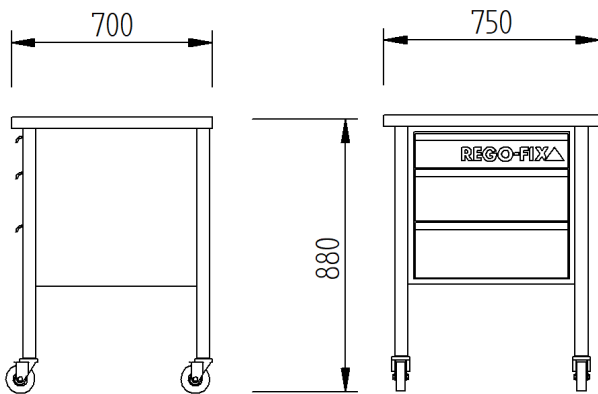

Achieve perfect torque with any wrench

TORCO-BLOCK The only tool assembly device in the market that is comfortable and safe to use with integrated torque measuring. Usability is given for all collet based systems and available for all standard machine interfaces.

TORCO-BLOCK provides

- // Use any wrench and still be able to correctly measure tightening torque
 - // Minimal effort for toolclamping needed
 - // Toolholder will not be overtorqued
 - // Correct tightening torque guaranteed, no bad runout due to overtorquing
 - // Quick-change function for different taper interfaces with only one 4 mm Allen-key within seconds
 - // Safe assembling of cutting tools
 - // Easy and quick toolholder and adapter handling
 - // Required footprint 170 x 270 mm
 - // Correct installation of pull studs with standard wrenches
 - // Full or overhang mounting on a workbench possible
 - // TORCO-BLOCK supplied inclusive 10 indicator rings TB / IR
- Unit needs a stable workbench to be attached to with at least four M10 screws.*

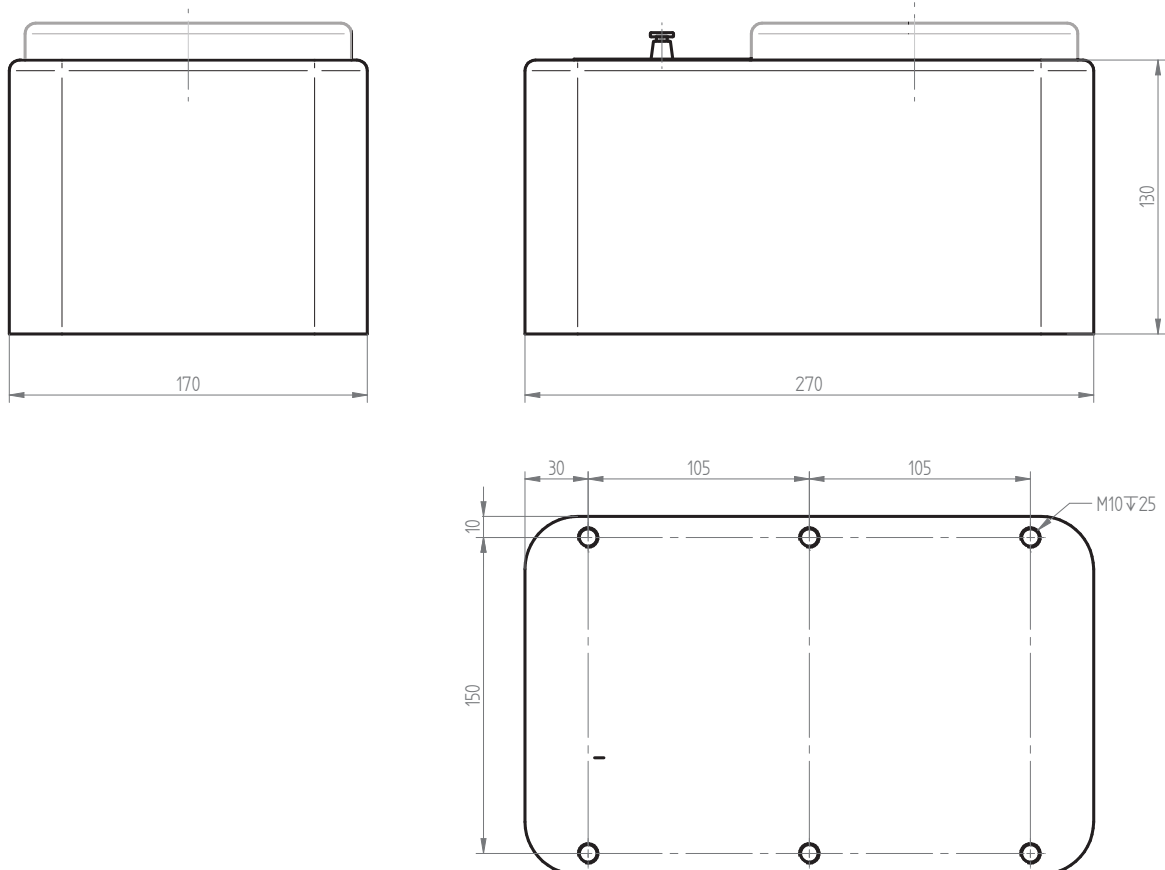

TORCO-BLOCK and components

Type	Part no.
Tool assembly with torque measurement	
TORCO-BLOCK	7815.00000

Included in delivery: TORCO-BLOCK and 10 indicator ring set (no tool adapters)

Indicator ring set/ 10 rings	
SET TB/IR	7816.99999

Tool adapter for CAT spindle interfaces	
TB/BT 30 & CAT 30	7816.30100
TB/SK 40 & CAT 40	7816.40200
TB/CAT 50	7816.50300

Tool adapter for SK spindle interface	
TB/SK 30	7816.30200
TB/SK 40 & CAT 40	7816.40200
TB/SK 50	7816.50200

Tool adapter for BT spindle interface	
TB/BT 30 & CAT 30	7816.30100
TB/HSK 63 & C6 & BT 40	7816.63500
TB/HSK 100 & BT 50	7816.00500

Type	Part no.
Tool adapter for HSK & REGO-FIX CAPTO	
TB/HSK 25	7816.25500
TB/HSK 32 & C3	7816.32500
TB/HSK 40 & C4	7816.40500
TB/HSK 50 & C5	7816.50500
TB/HSK 63 & C6 & BT 40	7816.63500
TB/HSK 100 & BT 50	7816.00500

REGO-FIX CAPTO – licensed by Sandvik Coromant



Taper cleaner

The REGO-FIX Taper cleaning device is designed to clean toolholder interfaces from oil, emulsion and other impurities with interchangeable brush head canopies mounted on a base motor.

- // Maintain runout accuracy of cutting tool
- // Protect machine spindle
- // Maintain lasting precision of interface



Cleaning Adapter



Base Unit

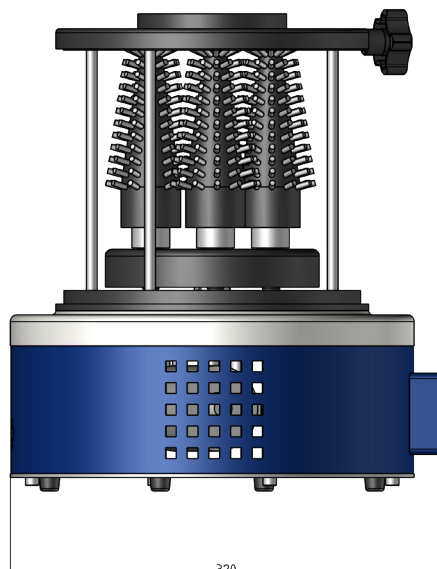
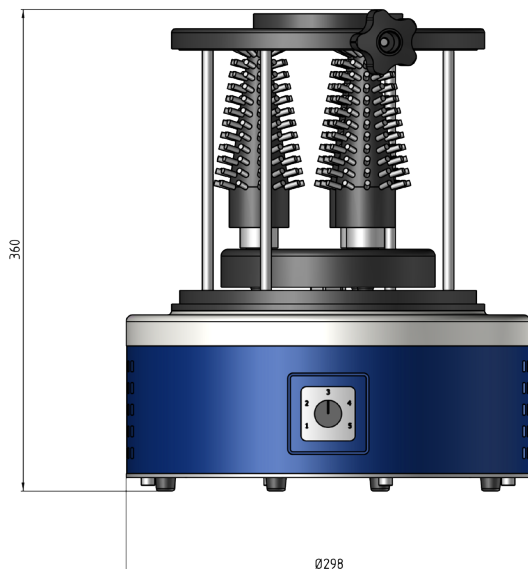

Type

Part no.

Taper Cleaning Device (Base Unit)

TCD-BU	7821.00000
--------	------------

Cleaning Adapter (Brush Head)

TCD/SK 30	7822.30100
TCD/SK 40	7822.40100
TCD/SK 50	7822.50100
TCD/HSK-A/C/E 40	7822.40300
TCD/HSK-A/C/E 63	7822.63300
TCD/HSK-A/C/E 100	7822.00300

Other cleaning adapters available on request

Coolant tubes KSR

KSR

SKR

Wrenches for coolant tubes SKR

Type	Part no.	Dimensions [mm]			G	System
		D	L	L1		
Coolant tubes KSR						
KSR 25	7211.25000	5	4.5	17	M 8 x 1	●●●●
KSR 32	7211.32000	6	5.5	25.7	M 10 x 1	●●●●
KSR 40	7211.40000	8	7.5	29.2	M 12 x 1	●●●●
KSR 50	7211.50000	10	9.5	32.7	M 16 x 1	●●●●
KSR 63	7211.63000	12	11.5	36.2	M 18 x 1	●●●●
KSR 80	7211.80000	14	13.5	39.7	M 20 x 1.5	●●●●
KSR 100	7211.00000	16	15.5	43.6	M 24 x 1.5	●●●●
KSR 125	7211.12500	16	15.5	43.6	M 24 x 1.5	●●●●

Type	Part no.	System
Wrenches SKR		
SKR 25	7212.25000	●●●●
SKR 32	7212.32000	●●●●
SKR 40	7212.40000	●●●●
SKR 50	7212.50000	●●●●
SKR 63	7212.63000	●●●●
SKR 80	7212.80000	●●●●
SKR 100	7212.00000	●●●●
SKR 125	7212.12500	●●●●

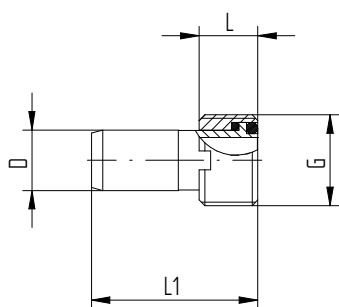

KSR

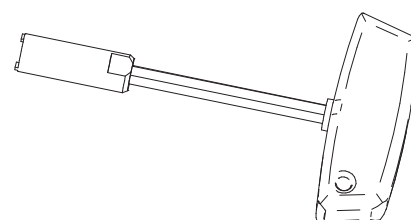

SKR



Trays for ER collet sets ZWT
Trays for ER collet sets ZZT [inch]
Trays for sealing disk sets DSR
Trays for PG collets CTPG

- ZWT
- ZZT
- DSR
- CTPG

Type	Part no.	fits ... items	System
Trays for ER collet sets ZWT			
ZWT 8	7121.08000	9	●
ZWT 11	7121.11000	13	●●
ZWT 16	7121.16000	10	●●
ZWT 20	7121.20000	12	●
ZWT 25	7121.25000	15	●●
ZWT 32	7121.32000	18	●●
ZWT 40	7121.40000	23	●
ZWT 50	7121.50000	12	●

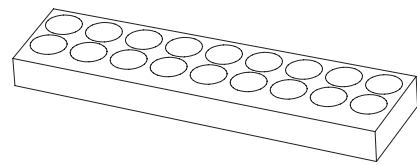

ZWT / ZZT

Trays for ER collet sets ZZT*			
ZZT 8	7121.08300	9	●
ZZT 11	7121.11300	13	●●
ZZT 16	7121.16300	10	●●
ZZT 20	7121.20300	12	●
ZZT 25	7121.25300	15	●●
ZZT 32	7121.32300	18	●●
ZZT 40	7121.40300	23	●

*USA only

Trays for sealing disk sets DSR			
DSR 16	7122.16000	14	●●
DSR 20	7122.20000	20	●
DSR 25	7122.25000	26	●●
DSR 32	7122.32000	34	●●
DSR 40	7122.40000	46	●

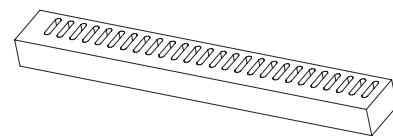

DSR

Trays for PG collets CTPG			
CTPG 6	7698.06000	20	●
CTPG 10	7698.10000	14	●
CTPG 15	7698.15000	15	●
CTPG 25	7698.25000	16	●
CTPG 32	7698.32000	12	●

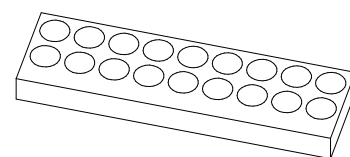

CTPG



Technical information

Discover powRgrip®	268	Reduction sleeves	301
ER clamping system	270	Spindle interface norms	304
micRun® System	272	HSK forms and their key characteristics	305
XL vibration damping	274	HSK interface	306
secuRgrip®	276	Balancing	308
Mastering both wet and dry applications	278	DIN 69888:2008-09	315
Cryogen cooling	280	Milling strategies	316
powRgrip® System nose diameter comparison	282	Troubleshooting milling/drilling/reaming/tapping	318
Presetting range of powRgrip® collets	284	Formulas for cutting data	322
Assembly instructions for ER and MR collets	290	Cutting speed conversion table for threading	323
Instructions for correct clamping of tool shanks	291	Hardness chart	324
Increasing collet and tool life	292	Conversion chart/inch-metric	325
Recommended tightening torque (ER/MR clamping nuts)	293	Form and position tolerances in practice	326
ER collets dimensions	295	Tolerance charts	330
Dimensions for ER collet cavities and clamping nuts	298	Thread tolerances	331
Tapping collets ER-GB	299	Core hole diameters for thread cutting	332
Tapping collets PCM ET1	300	Shank diameter of taps	336
Microbore collets ER-MB	300	Material comparison chart	337
		Terminology	351

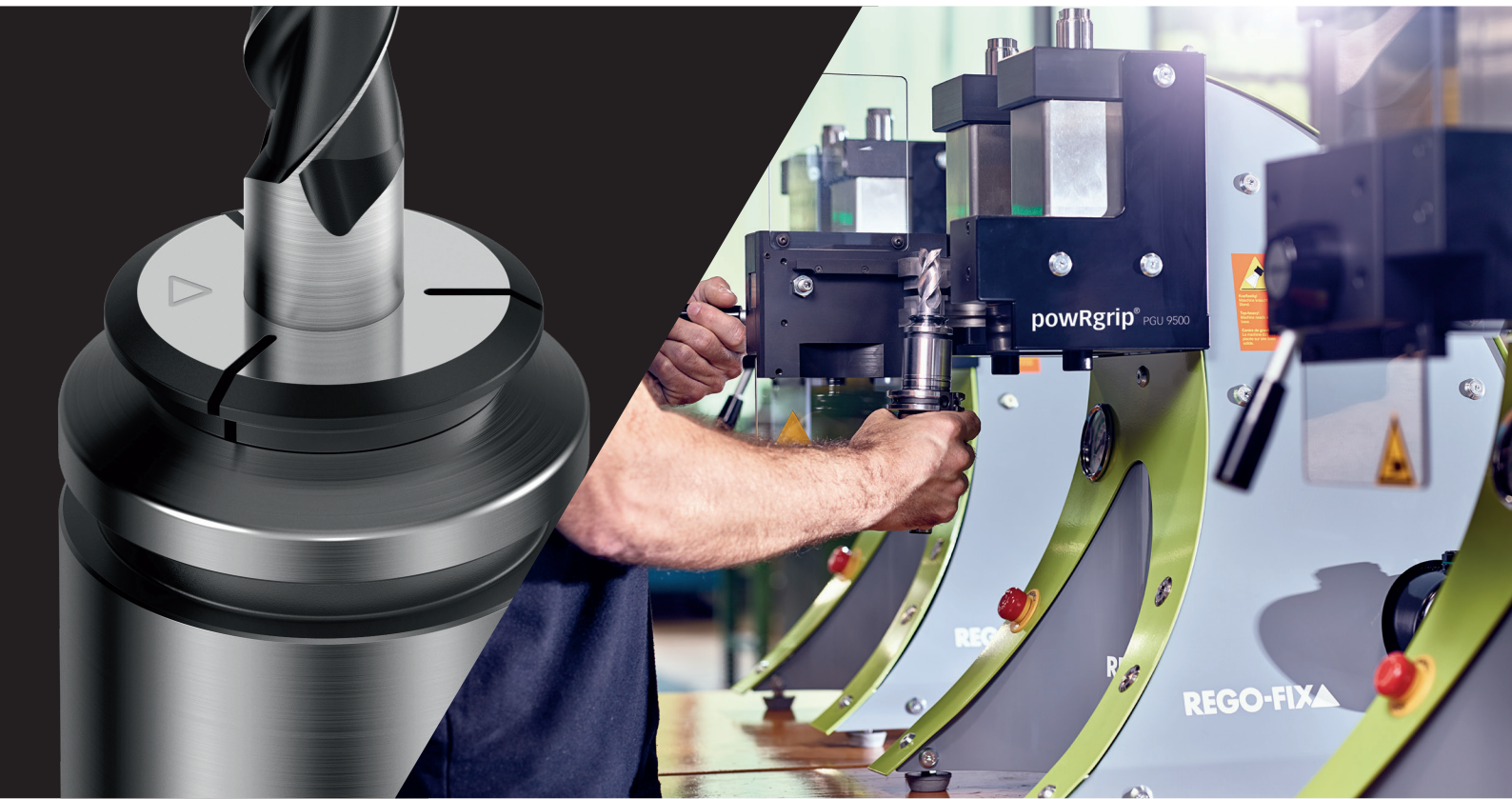

Meeting high machining demands

The powRgrip® System provides excellent runout, high vibration damping as well as easy and secure handling for demanding high-speed milling and drilling.

Power and precision combined An outstanding tool runout is one of the most positive influences on enhancing your tool life.

SIMPLE

Tool is clamped in 8 seconds by pushing only one single button.

SAFE

No heat up – high clamping force.

powRgrip®

The tool clamping system of today and the future.

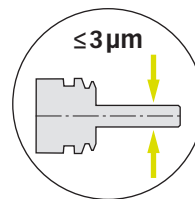

Total system runout TIR
≤3µm at 3xD.

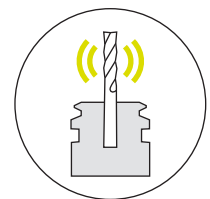

Excellent vibration damping.

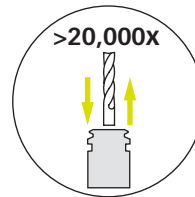

Maximum clamping force and
low runout, even after 20,000 tool
changes.

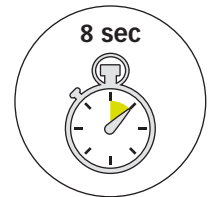

Tool ready for use
in 8 seconds.

Increased cutter tool life with the powRgrip® System

Influence of tool runout on tool life / Source: In-house testing

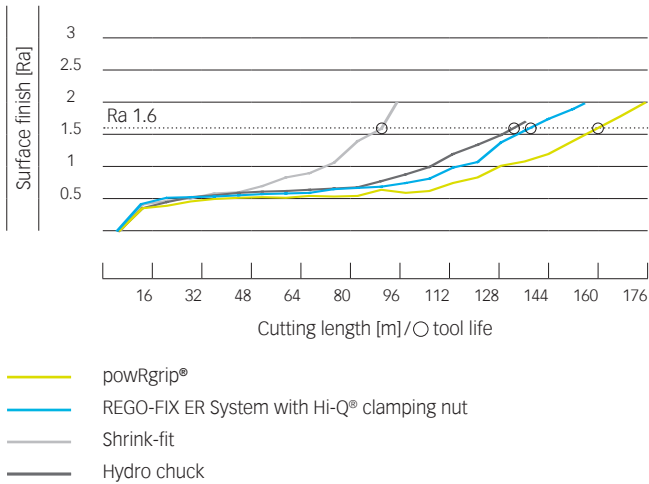

Transferable torque of the powRgrip® System

Measured transferable torque per shank diameter / Source: In-house testing

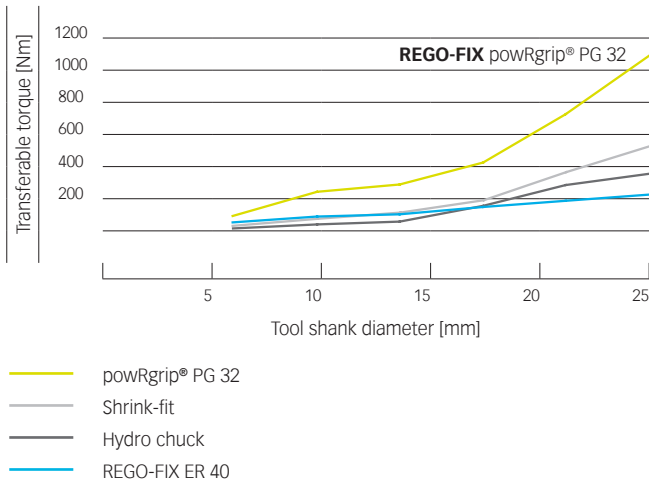

All tool shanks are clampable

All kind of materials such as carbide or HSS as of cylindrical, WELDON or Whistle Notch can be clamped with powRgrip®.



Extensive collet range

Tools with shank diameters from 0.2 to 25.4 mm (1") can be clamped for milling, reaming, drilling and as well for turning applications. The possibilities of MQL, peripheral or internal cooling are given.



Wide range of toolholders

powRgrip®-toolholders are available for many spindle interfaces e.g. REGO-FIX CAPTO, BT, BT+, SK, SK+, HSK, CAT, CAT+ or cylindrical spindle interfaces. Discover our wide product range at www.rego-fix.com.

Measurement of vibrations | powRgrip®

Amplitude indication of the REGO-FIX powRgrip® toolholder

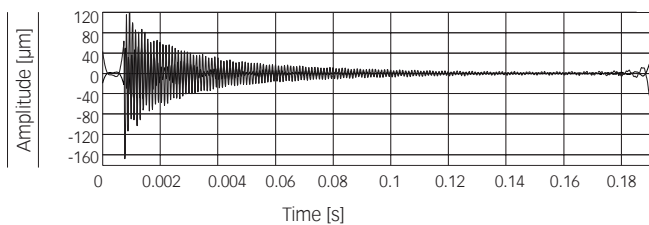

Measurement of vibrations | Shrink-fit holder

Amplitude indication of a standard shrink-fit holder

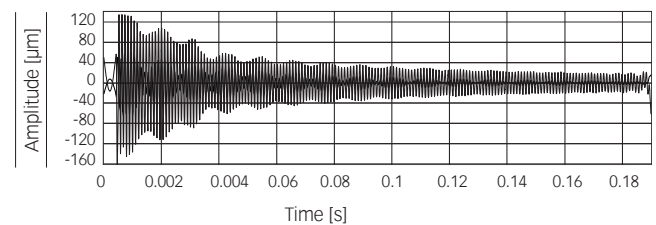

Test and comparison done by:



Expert advice

Test powRgrip® free of charge! Get more information at try.rego-fix.ch/toollife.

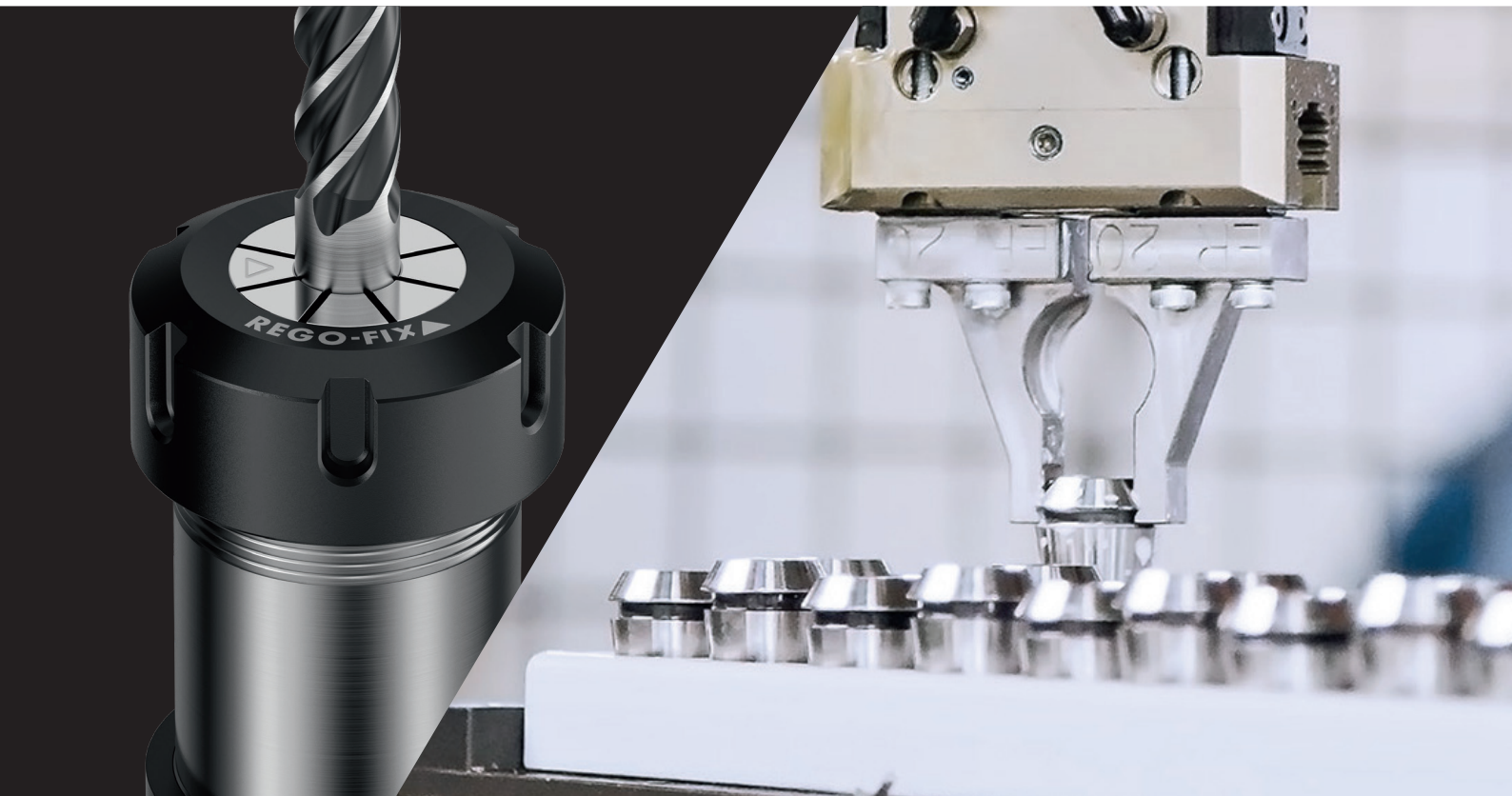

Defining toolholding standards

When REGO-FIX first introduced the ER System in 1972, it took the machining world by storm. With the DIN 6499 standardization twenty years later, the REGO-FIX ER collet became the industry standard. Today, the ER System is still the most used toolholding system worldwide.

High quality matters An outstanding tool runout is one of the most positive influences on enhancing your tool life.

Extend tool life with the REGO-FIX ER range

Influence of tool runout on tool life / Source: In-house testing

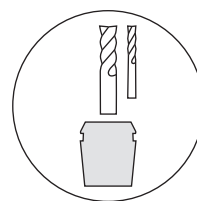
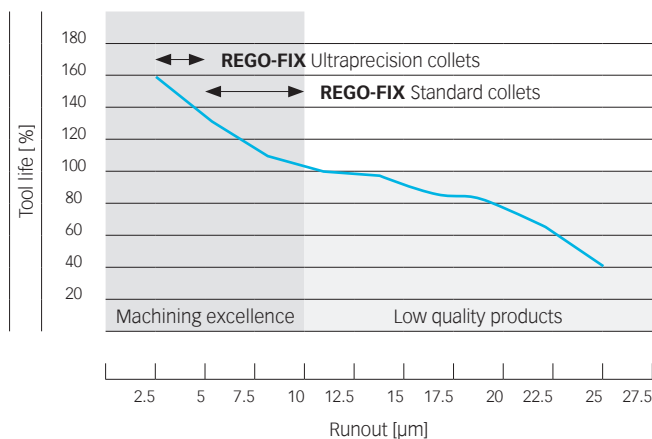

The widest ER product range: clamps all diameters from 0.2 mm – 36 mm.

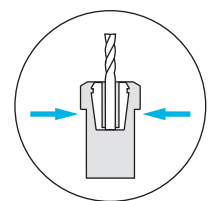

Safe and accurate toolholding of all shank types and materials.

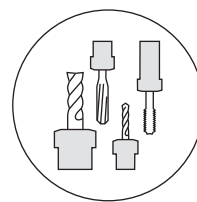

Outstanding flexibility for use with all tool types.

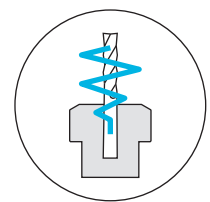

High vibration-damping results in longer tool life and best surface finish.

Successful clamping since 1972

Combine our ER toolholders with our ER collets to ensure maximum precision and balance to maximize your tool life. All our products bear the REGO-FIX triangle – our seal for outstanding Swiss quality.

Meet highest requirements defined by Swiss standards Swiss people are known to be humble and conservative: All our measuring data are to be considered as maximum values. Many other manufacturers are showing the common

measured total internal runout (TIR average). With us, you get maximum guaranteed values – To your advantage most of the values are even considerably lower.

Runout TIR of ER standard, ER-UP and MR collets

Clamping diameter d [mm]			TIR max. [mm]			
>	≤	L	DIN 6499			
			ISO 15488 B	ΔER std.	ΔER-UP	ΔMR
1	1.6	6	0.015	0.01	0.005	0.002
1.6	3	10	0.015	0.01	0.005	0.002
3	6	16	0.015	0.01	0.005	0.002
6	10	25	0.015	0.01	0.005	0.002
10	18	40	0.02	0.01	0.005	0.002
18	26	50	0.02	0.01	0.005	0.002
26	36	60	0.025	0.01	0.005	0.002

$L = \leq 3xD$

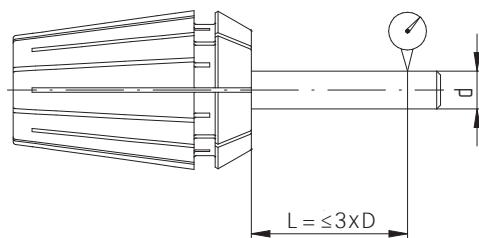

Key advantages

Rely on the original

Wide clamping range

The slot design allows for a wide clamping range with best runout TIR along the entire clamping range.

Broad range of products

We offer sizes from ER 8 up to ER 50 and diameters from 0.2 mm up to 36 mm.

Up to 20% more clamping length

Improve your runout with up to 20% more clamping length in smaller diameters.

Matched tooling system for best fit

The compatibility of the entire system results in maximum precision, balance and tool life.



Every micron counts

Closing the gap between the powRgrip® and the ER System, the micRun® System performs with a total system runout of $\leq 3\mu\text{m}$.

Swiss high precision An excellent runout accuracy paired with superior vibration damping, not only increases your machining quality, but enhances your overall productivity. It also increased your tool life, thus successfully lowering your cutter costs. With a total system runout of $\leq 3\mu\text{m}$ at $3 \times D$, the micRun® System provides all the benefits of excellent runout accuracy.

This is why micRun® is the ideal system for all micro machining applications and is successfully used in industries like watchmaking or medical engineering. In addition, our unique collet-locking system retains the collet safely inside the nut. This minimizes your risk of faulty operations or possible damages which may occur if the collet accidentally falls to the ground. Another great benefit of our collet-locking system is the tool-free removal of the collet.

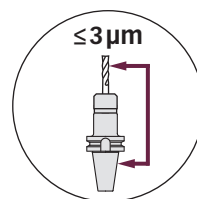

Total system TIR $\leq 3\mu\text{m}$ at $3 \times D$.

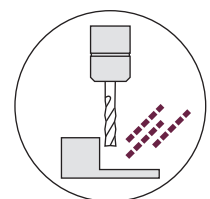

Designed for high-speed cutting.

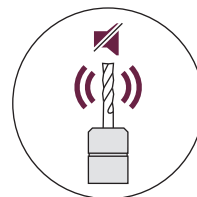

Silent and low vibration due to grooveless clamping nut.

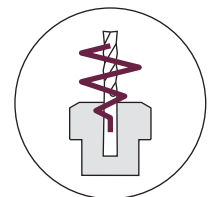

High vibration-damping results in longer tool life and best surface finish.



REGO-FIX  Swiss Made micRun@System
TC40/MR16x070 5240.11630.100

REGO-FIX  Swiss Made micRun@System
TC40/MR11x100 5240.11150.100

micRun@System
1650.100

XL vibration damping

Optimize your surface finish and extend tool life by minimizing occurring vibrations during machining.

Minimize tool vibrations The MICRO-FRICTION DAMPING™ (MFD) technology (pat. pend.) by REGO-FIX allows our XL toolholders to dissipate vibrations faster than standard long-reach toolholders. Damping the vibrations faster means that your cutting tool, part and spindle will see less vibrations resulting in better surface finishes, longer tool life and less spindle wear. All REGO-FIX XL toolholders are balanced to G 2.5 @ 5,000 rpm.

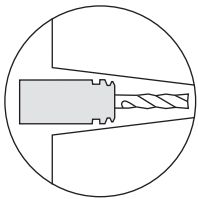

Minimal outside dimensions: long and slim design.



Exclusive vibration-damping design.

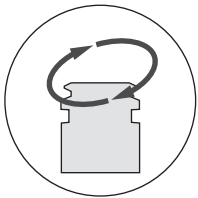

Balanced by design.

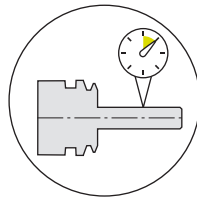

Total system runout TIR $\le 10 \mu\text{m}$ at 3xD.



Vibration chart

Decay of REGO-FIX XL toolholder **with vibration-damping design**

Source: In-house testing

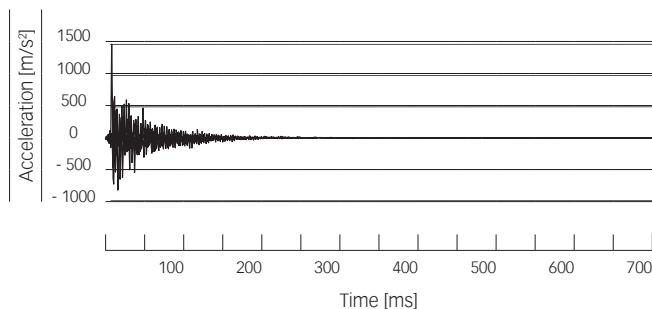

Vibration chart

Monoblock standard toolholder **without vibration-damping design**

Source: In-house testing

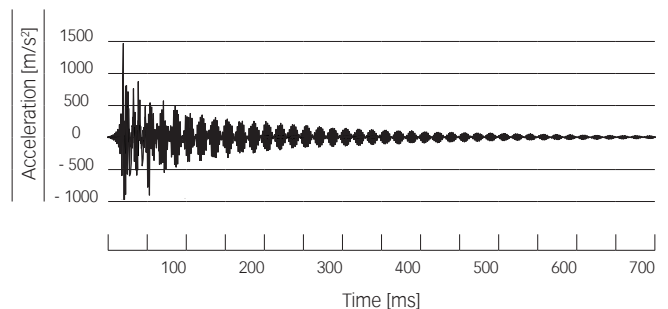



RPM recommendations for XL toolholders

Thanks to a wide XL toolholder program, we offer for each of your applications the right solution. Unleash the full potential by respecting the appropriate working conditions.

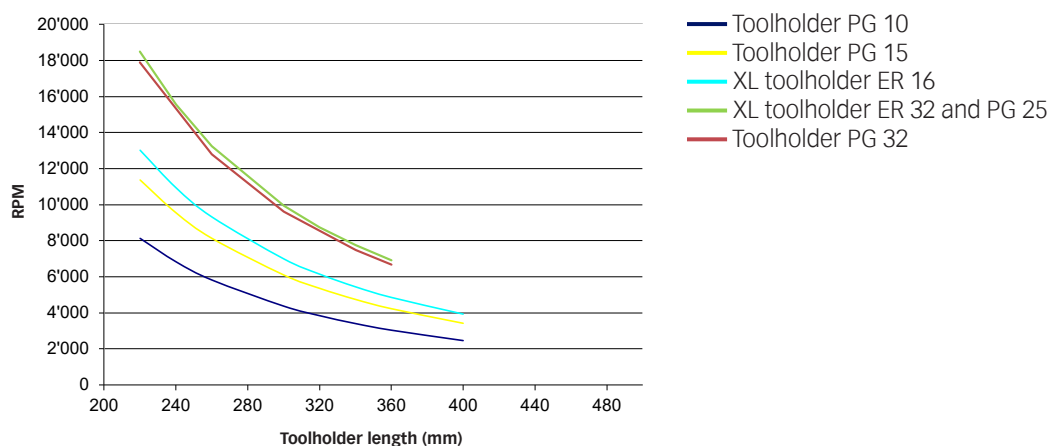

Calculation of the maximum speed of a shaft with cantilever bearing. Calculated values without consideration of:

- // Balancing quality (Overall-system)
- // Machine spindle (Stability)
- // Projection length of the cutting tools

The maximum speeds are directly dependent on the properties of the spindle and the machining forces.

These are standard guidelines for REGO-FIX Xtended Length toolholders. No guarantee can be given for the maximum speeds of the entire system.

Form-fit for 100% pullout protection

With our innovative secuRgrip® solution, we offer a total tool pullout protection for the ER and powRgrip® System.

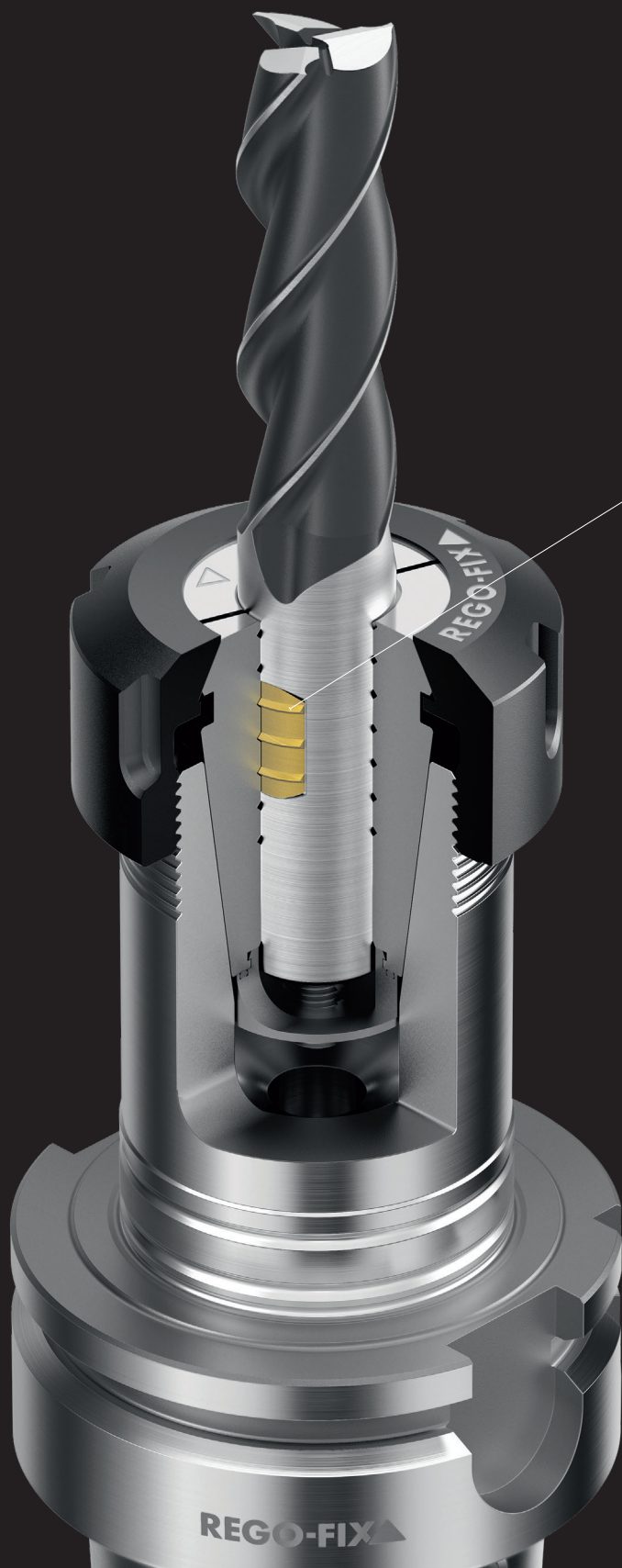

Threaded insert for end mill flat

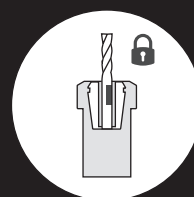

SecuRgrip® is available for all standard tools with Weldon flat (10–25.4 mm), without additional modifications.

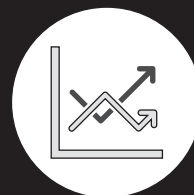

Increase productivity through process reliability.

REGO-FIX ▲

Safe machining even for difficult-to-handle workpieces

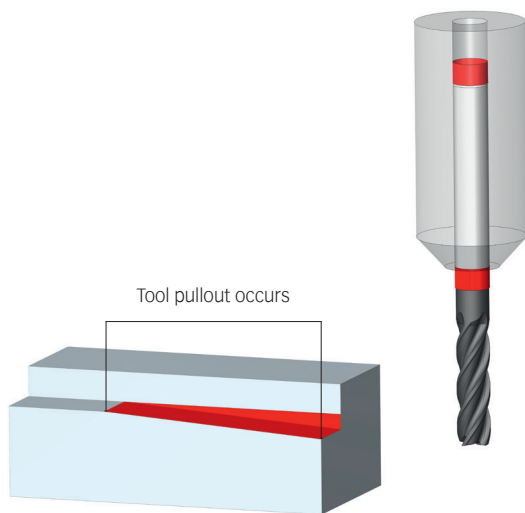

Length alterations can lead to damage of the workpiece.

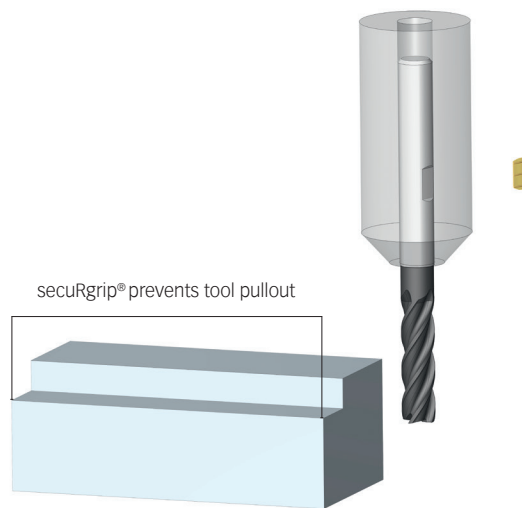

Prevent workpiece damage by using REGO-FIX secuRgrip®.

Full protection where you need it The secuRgrip® threaded insert is designed to fit in any tool with a Weldon flat. This way you can use the tool of your choice. In combination with our secuRgrip® collet, we offer the ultimate tool pullout protection at a competitive price.

Avoiding length alterations caused by tool pullout results in improved process reliability and ultimately improves your overall machining productivity. Our secuRgrip® solution is available for ER 32 and ER 40 as well as for PG 15, PG 25 and PG 32 – just the right sizes when it comes to rough machining.

- // No additional costs for replacing damaged tools, thanks to ER and PG secuRgrip®
- // No modification of the tool shank is required
- // Extra protection for worry-free machining, especially with expensive work pieces

Expert advice

secuRgrip® is available for ER and powRgrip®.

Mastering both wet and dry applications

We offer efficient solutions for specific machining techniques and different work materials to maximize your machining.

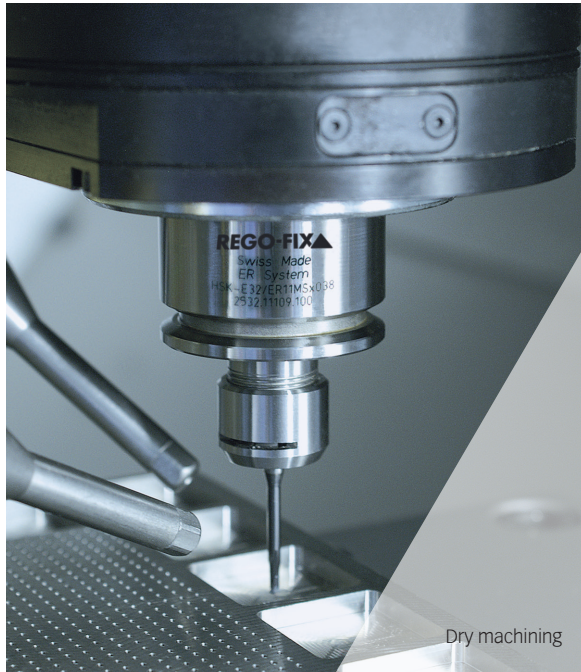

Dry machining is mainly used for specific machining techniques and work materials, such as carbon, high-tensile plastics or wood.

Pros

- // Reduced initial machine investment costs
- // Simple and easy cleaning
- // Clear sight on point of action between tool and workpiece

Cons

- // Inadequate heat dissipation can lead to a reduced tool life
- // Increased tooling costs due to earlier wear and tear
- // Extended production cycles due to slower possible production speed



The cutting edge is subject to thermal strains. Wet machining thus helps to regulate the impact of high heat that occurs during milling, ultimately protecting the tool against total tool failure.

Pros

- // Fast and effective heat dissipation
- // Improved surfaces thanks to lubrication of cutting edge
- // Clean and easy chip removal
- // Production cycles can be increased leading to an overall increase of productivity
- // Lowered tool costs

Cons

- // Additional costs for the acquisition of a pump
- // Limited view on point of action
- // Wet surroundings may present as an ideal bacteria breeding ground

Supplying the right amount of coolant to where it matters



Key features of external flood cooling

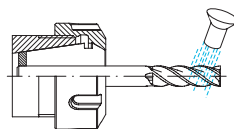

- // Universal application possibilities
- // Problems may arise with deep cavities
- // Reduction of tool life because cooling is not right on the cutting edge
- // Suboptimal chip deflection
- // Limited adjustment of nozzles due to different tool lengths and diameters



Key features of peripheral cooling

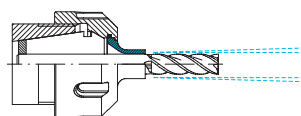

- // Coolant is fed along the side of the tool to the cutting edge
- // Can be used for moderate cavities
- // Achieve peripheral cooling with reCool® and the use of our coolant flush disk KS / ER or PG-CF collet

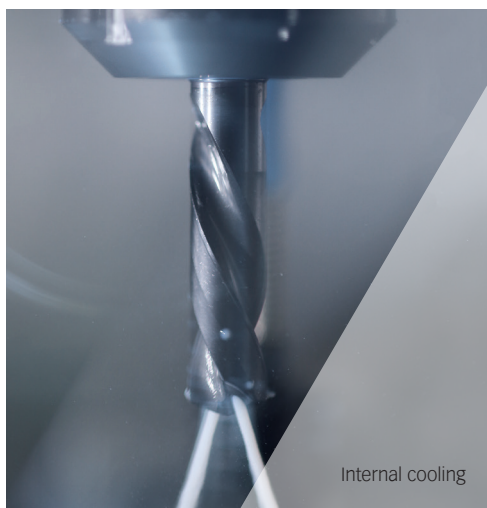

Key features of internal cooling

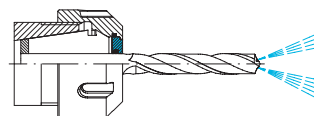

- // Precise cooling at the cutting edge and improved chip removal
- // Particularly suitable for deep cavities
- // Deep hole drilling and threading
- // Lubrication of cutting edge and cooling
- // Best surface quality
- // Achieve internal cooling with reCool® and the use of our sealing disk DS / ER



Cryogen: Coolant at the right spot

COOL

CO₂ cools the cutting edge in a safe and clean way, thanks to powRgrip® with an optimum dosage.

CLEAN

No contamination at all, therefore no necessity to do additional cleaning of the workpiece afterwards.

CRYO-powRgrip®

PG-CRYO collets offer the latest tool cooling technology for a clean chipping of workpieces (i.e. medical industries).

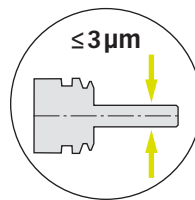

Total system runout TIR
≤3µm at 3xD.

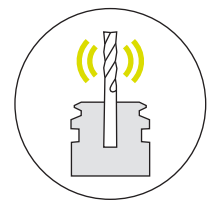

Excellent vibration damping.

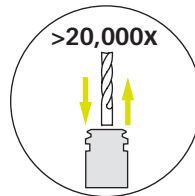

Maximum clamping force and low
runout, even after 20,000 tool
changes

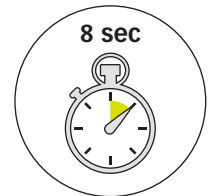

Tool ready for use in
8 seconds with PGU 9500.

The major difference of toolholding systems

Solution: reducing of the condensation space

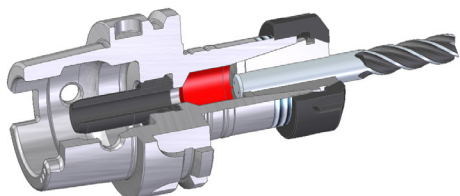

ER toolholder

Typical tool clamping system, with the risk of icing of the holder, due to the gaseous state behaviour of CO₂.

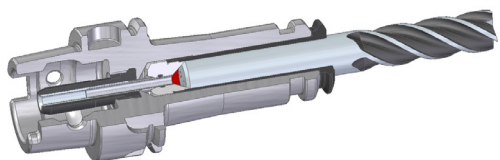

PG-CRYO toolholder

The cooling medium will be directly led to the cutting edge through the cutting tool. The CO₂ expands at the cutting edge and the ice snow provides an efficient and clean chipping

State of aggregation diagram CO₂

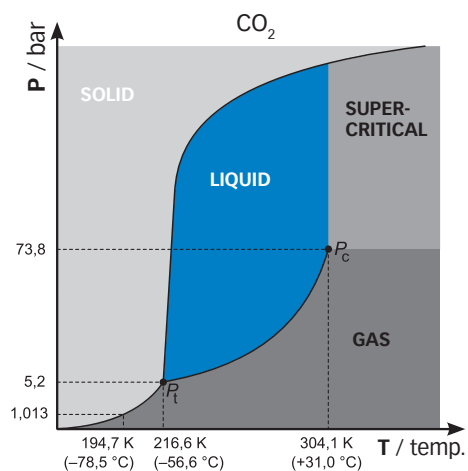

Benefit of CRYO-powRgrip®

- // Perfect guidance of the cooling medium to the cutting edge
- // Tool life increase
- // Productivity increase, due to higher cutting parameters
- // Better surface finishing
- // No disposal of the cooling fluid necessary
- // No necessity of workpiece cleaning
- // 100% recycling of the chips

For peripheral external cooling

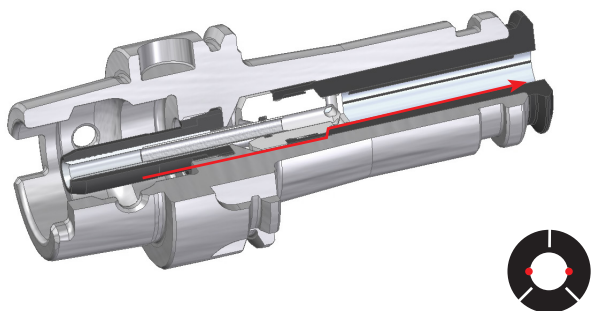

For internal cooling

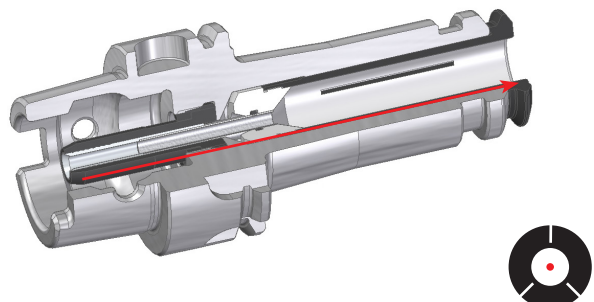

powRgrip® System and secuRgrip® nose diameter comparison

Standard nose diameter comparison

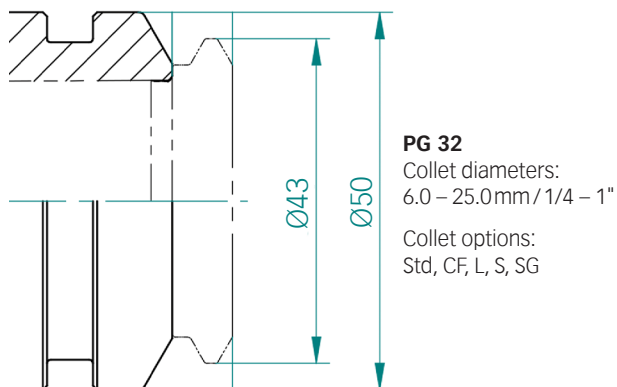
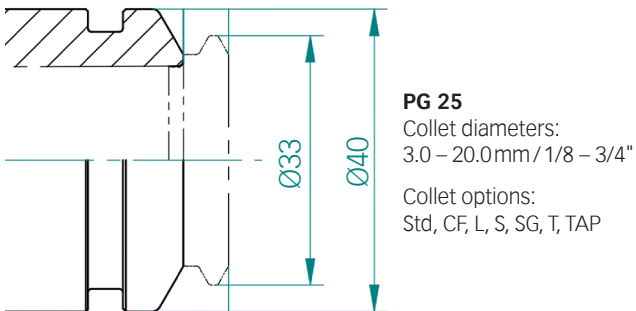
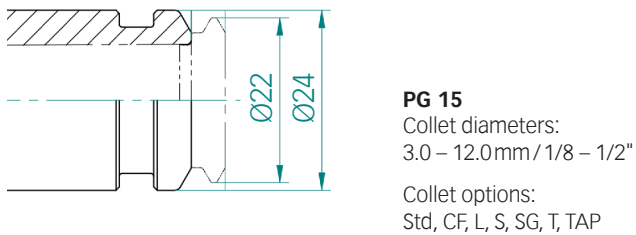

secuRgrip® nose diameter comparison

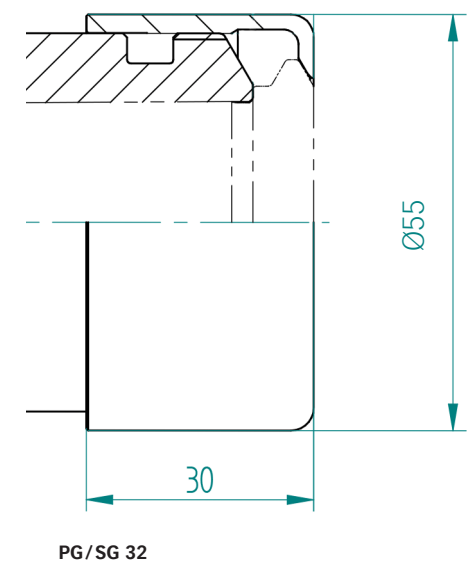
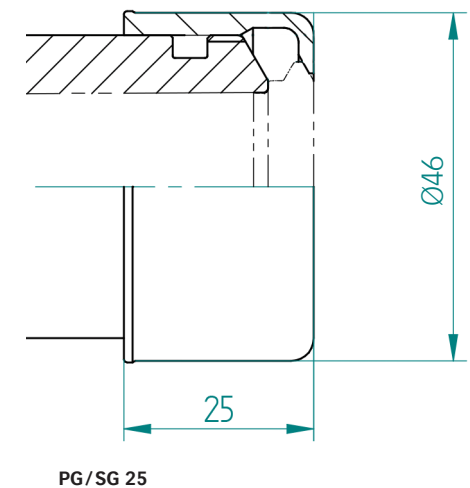
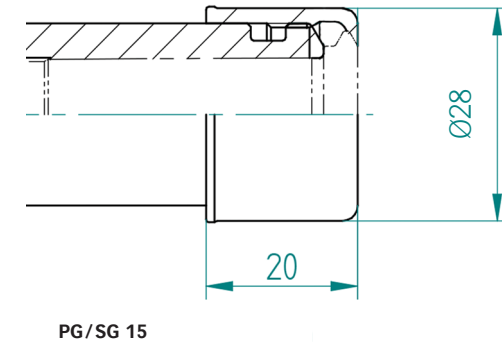



Presetting range of powRgrip® collets

D	D	PG 6/-CF		PG 6-S		PG 10/-CF		PG 10-S		PG 15/-CF/TW		PG 15-S		PG 15-L**		PG 25/-CF	
		L [mm]		L [mm]		L [mm]		L [mm]		L [mm]		L [mm]		L [mm]		L [mm]	
[mm]	[inch]	min.	max.	min.	max.	min.	max.	min.	max.	min.	max.	min.	max.	min.	max.	min.	max.
02-1.0	-	21.5	26.5*	-	-	20	24*	-	-	-	-	-	-	-	-	-	-
1.5	-	23.5	26.5*	-	-	16	20*	-	-	-	-	-	-	-	-	-	-
-	1/16"	23.5	26.5*	-	-	16	20*	-	-	-	-	-	-	-	-	-	-
2.0	-	24	26.5	-	-	25	30	-	-	-	-	-	-	-	-	-	-
2.5	-	24	26.5*	-	-	25	30	-	-	-	-	-	-	-	-	-	-
3.0	-	24	26.5	17	20	25	30	20.5	26	25	30	-	-	-	-	25	32,5
-	1/8"	24	26.5	17	20	25	30	20.5	26	25	30	18	25	-	-	25	32,5
3.5	-	-	-	-	-	25	30	-	-	25	30	-	-	-	-	25	32,5
4.0	-	23.5	26.5*	-	-	25	30	20.5	26	25	30	18	25	25	53	25	32,5
4.5	-	-	-	-	-	25	30	-	-	25	30	-	-	-	-	25	32,5
-	3/16"	-	-	-	-	25	30	20.5	26	25	30	18	25	-	-	25	32,5
5.0	-	-	-	-	-	25	30	-	-	25	30	18	25	25	53	25	32,5
5.5	-	-	-	-	-	25	30	-	-	25	30	-	-	-	-	25	32,5
6.0	-	-	-	-	-	30	35	23.5	29	33	38	26	33	33	53	33	40.5
-	1/4"	-	-	-	-	30	35	23.5	29	33	38	26	33	33	53	33	40.5
7.0	-	-	-	-	-	-	-	-	-	33	38	-	-	-	-	33	40.5
-	5/16"	-	-	-	-	-	-	-	-	33	38	26	33	33	53	33	40.5
8.0	-	-	-	-	-	-	-	-	-	33	38	26	33	33	53	33	40.5
9.0	-	-	-	-	-	-	-	-	-	33	38	-	-	-	-	33	40.5
-	3/8"	-	-	-	-	-	-	-	-	37	40.5	31	38	37	53	37	44.5
10.0	-	-	-	-	-	-	-	-	-	37	40.5	31	38	37	53	37	44.5
11.0	-	-	-	-	-	-	-	-	-	-	-	-	-	-	-	37	44.5
-	7/16"	-	-	-	-	-	-	-	-	-	-	-	-	-	-	37	44.5
12.0	-	-	-	-	-	-	-	-	-	41.5*	45*	-	-	-	-	42	49.5
-	1/2"	-	-	-	-	-	-	-	-	41.5*	45*	-	-	-	-	42	49.5
13.0	-	-	-	-	-	-	-	-	-	-	-	-	-	-	-	42	49.5
14.0	-	-	-	-	-	-	-	-	-	-	-	-	-	-	-	42	49.5
-	9/16"	-	-	-	-	-	-	-	-	-	-	-	-	-	-	42	49.5
15.0	-	-	-	-	-	-	-	-	-	-	-	-	-	-	-	42	49.5
-	5/8"	-	-	-	-	-	-	-	-	-	-	-	-	-	-	45.5	50
16.0	-	-	-	-	-	-	-	-	-	-	-	-	-	-	-	45.5	50
18.0	-	-	-	-	-	-	-	-	-	-	-	-	-	-	-	45.5	50
-	3/4"	-	-	-	-	-	-	-	-	-	-	-	-	-	-	47.5	50
20.0	-	-	-	-	-	-	-	-	-	-	-	-	-	-	-	47.5	50
22.0	-	-	-	-	-	-	-	-	-	-	-	-	-	-	-	-	-
-	7/8"	-	-	-	-	-	-	-	-	-	-	-	-	-	-	-	-
25.0	-	-	-	-	-	-	-	-	-	-	-	-	-	-	-	-	-
-	1"	-	-	-	-	-	-	-	-	-	-	-	-	-	-	-	-

*CF not available **PG-L without stop screw

Presetting range of powRgrip® collets

D	D	PG 25-S		PG 25-L**		PG 32/-CF		PG 32-S		PG 32-L**	
		L [mm]	L [mm]	L [mm]	L [mm]	L [mm]	L [mm]	L [mm]	L [mm]	L [mm]	L [mm]
[mm]	[inch]	min.	max.	min.	max.	min.	max.	min.	max.	min.	max.
0.2-1.0	-	-	-	-	-	-	-	-	-	-	-
1.5	-	-	-	-	-	-	-	-	-	-	-
-	1/16"	-	-	-	-	-	-	-	-	-	-
2.0	-	-	-	-	-	-	-	-	-	-	-
2.5	-	-	-	-	-	-	-	-	-	-	-
3.0	-	-	-	-	-	-	-	-	-	-	-
-	1/8"	18	25	-	-	-	-	-	-	-	-
3.5	-	-	-	-	-	-	-	-	-	-	-
4.0	-	18	25	-	-	-	-	-	-	-	-
4.5	-	-	-	-	-	-	-	-	-	-	-
-	3/16"	18	25	-	-	-	-	-	-	-	-
5.0	-	-	-	-	-	-	-	-	-	-	-
5.5	-	-	-	-	-	-	-	-	-	-	-
6.0	-	26	33	33	65	33.5	40.9	-	-	-	-
-	1/4"	26	33	33	65	33.5	40.9	-	-	-	-
7.0	-	-	-	-	-	33.5	40.9	-	-	-	-
-	5/16"	26	33	33	65	33.5	40.9	-	-	-	-
8.0	-	26	33	33	65	33.5	40.9	-	-	-	-
9.0	-	-	-	-	-	33.5	40.9	-	-	-	-
-	3/8"	30	38	37	65	35.5	44.9	-	-	-	-
10.0	-	30	38	37	65	35.5	44.9	-	-	-	-
11.0	-	-	-	-	-	35.5	44.9	-	-	-	-
-	7/16"	-	-	-	-	35.5	44.9	-	-	-	-
12.0	-	35	43	42	65	40.5	49.9	32	40.5	40.5	69
-	1/2"	35	43	42	65	40.5	49.9	32	40.5	40.5	69
13.0	-	-	-	-	-	40.5	49.9	-	-	-	-
14.0	-	35	43	42	65	40.5	49.9	35	43	40.5	69
-	9/16"	-	-	-	-	40.5	49.9	-	-	-	-
15.0	-	-	-	-	-	40.5	49.9	-	-	-	-
-	5/8"	38	46	45.5	65	43.5	52.9	38	46	-	-
16.0	-	38	46	45.5	65	43.5	52.9	35	43.5	43.5	69
18.0	-	-	-	-	-	43.5	52.9	-	-	-	-
-	3/4"	40	47.5	47.5	65	45.5	54.9	37	45.5	45.5	69
20.0	-	40	47.5	47.5	65	45.5	54.9	37	45.5	45.5	69
22.0	-	-	-	-	-	45.5	54.9	-	-	-	-
-	7/8"	-	-	-	-	45.5	54.9	-	-	-	-
25.0	-	-	-	-	-	49.5	58	41	49.5	49.5	69
-	1"	-	-	-	-	49.5	58	41	49.5	49.5	69

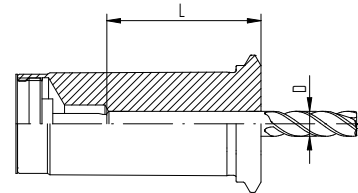

PG/PG-CF/PG-S/PG-L

*CF not available **PG-L without stop screw

Maximum presetting range for powRgrip® standard collets and PG-CF collets

Sizes	PG 6	PG 10	PG 15	PG 25	PG 32
L2 max.	26.5	35	40.5	50	58

L2: maximum depth (without stop screw)

Presetting range of PG-TAP collets with internal square

Dimensions [mm/inch]		PG 15-TAP [mm]		PG 25-TAP [mm]	
D	□	L min.	L max.	L min.	L max.
3.5	2.7	27	29	-	-
0.141"	0.110"	27	29	-	-
0.168"	0.131"	27	29	-	-
4.5	3.4	27	29	-	-
0.194"	0.152"	29	31	-	-
0.220"	0.165"	29	31	-	-
6	4.9	29	31	29	31
0.255"	0.191"	29	31	-	-
7	5.5	29	31	29	31
8	6.2	33.5	36	33.5	36
0.318"	0.238"	-	-	33.5	36
9	7	34.5	37	34.5	37
0.367"	0.275"	-	-	34.5	37
0.381"	0.286"	-	-	34.5	37
10	8	35.5	38	38.5	41
11	9	-	-	39.5	42
12	9	-	-	39.5	42
14	11	-	-	41.5	44
16	12	-	-	42.5	45

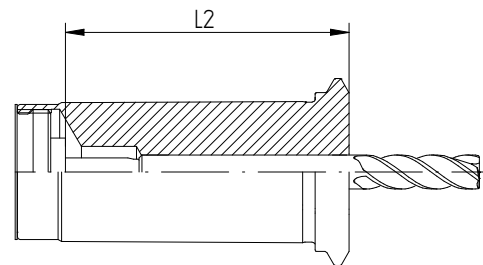

PG/PG-CF

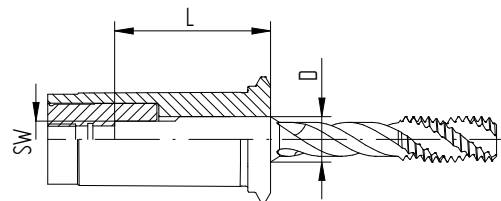

PG-TAP

Recommended tightening torque for secuRgrip® safety nuts

Safety nut type	Nut Ø [mm]	Recommended torque	Freewheel wrench head	TORCO-FIX
PG 15/SGN 15	28.00	50 Nm	A-FLS Ø 28,0/SG 15	II
PG 25/SGN 25	46.00	70 Nm	A-FLS Ø 46,0/SG 25	II
PG 32/SGN 32	55.00	80 Nm	A-FLS Ø 55,0/SG 32	II





The unbeatable advantages from the inventor of the ER collet

Wide selection available

- // Includes friction-bearing for higher clamping force
- // Available with sealing disk for coolant through tools
- // Mini nut with minimal external diameter
- // Clamping nut for high rpm
- // Externally threaded clamping nut for floating chucks, ERA Zero-Z[®] toolholder and live tooling
- // Slip-off proof mini clamping nut intrLox[®] for safe assembling

Torque comparison of different clamping nuts

REGO-FIX Hi-Q[®]/ER and Hi-Q[®]/ERB vs. competitor nuts

Source: In-house testing

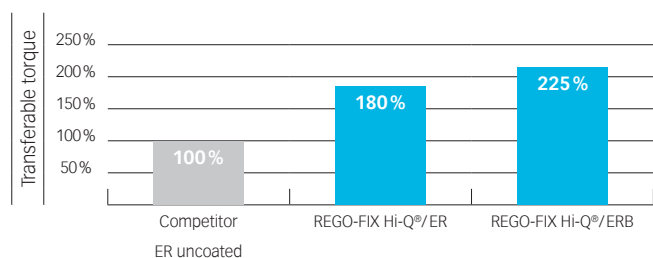

Balancing quality overview

REGO-FIX clamping nuts vs. competitor nuts / Source: In-house testing

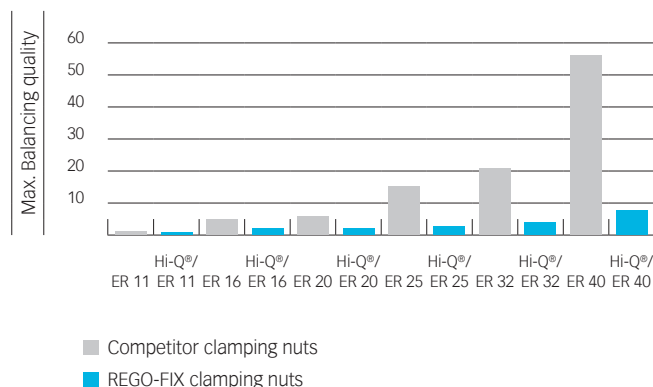

Key advantages

ER System

Collet locking system

Retains collet in nut for easier assembly.

Balancing

Ideal for high-speed applications.

Higher transferable torque

Lower frictional forces resulting in up to 80% higher gripping force over standard non-treated clamping nuts. With friction bearing nut up to 125%.

Protection against corrosion

With a special surface treatment for longer life.

Optimal contour

Rounded thread start prevents damaging of collets on tool changes.

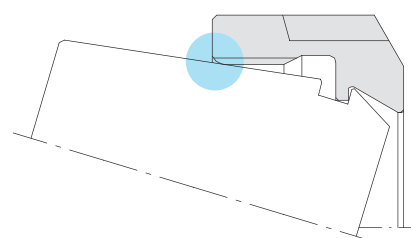

Swiss quality standard

Our products marked Swiss made are manufactured at our headquarters in Tenniken, Switzerland.

Assembly instructions for ER and MR collets

Collets ER 11–ER 50 and MR 11–MR 32 (with collet locking system)

Assembling Insert groove of the collet into eccentric ring of the clamping nut at the mark on the bottom of the nut. Push collet in the direction of the arrow until it clicks in. Insert tool. Screw nut with collet onto toolholder.

Disassembling After the nut is unscrewed from the toolholder, press on the face of the collet while simultaneously pushing sideways on the back of the collet opposite the mark until it disengages from the clamping nut.

Important Improper assembly can permanently damage the runout TIR of the collet and may result in the destruction of the clamping nut. Only mount nuts with correctly inserted collets. Never place the collet into the holder without first assembling into the nut.

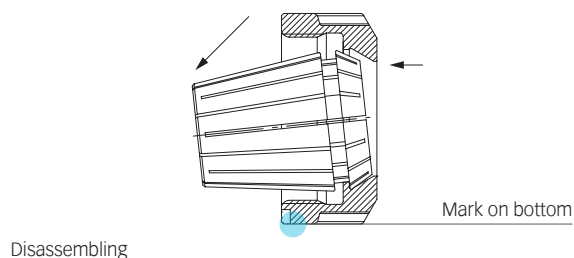
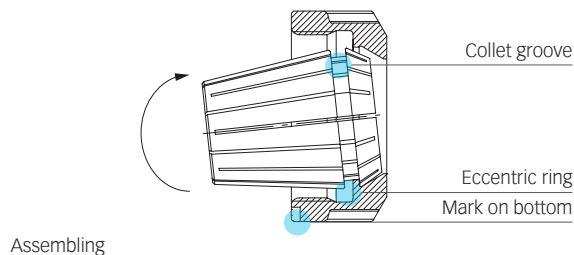

Collets ER 8 (without collet locking system)

Assembling Insert groove of the collet into eccentric ring of the clamping nut at the mark on the bottom of the nut. Insert tool. Hold nut with collet in horizontal position and screw onto toolholder.

Important The face of the ER 8 collet chuck must fit cleanly against the inner surface of the clamping nut. (ER 8 collets do not feature a 30° cone.)

Disassembling After unscrewing the clamping nut from the tool holder, the collet can easily be removed from the clamping nut.

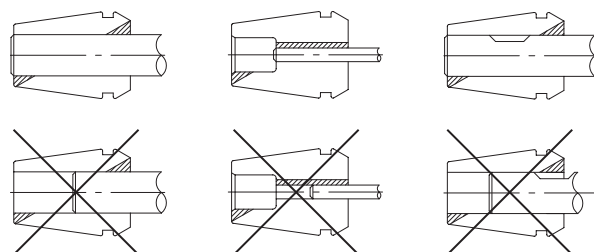
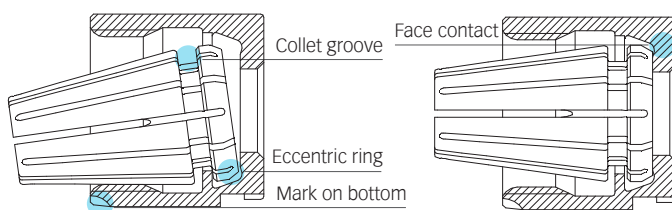
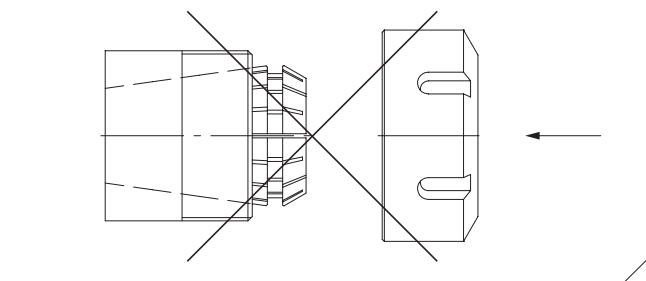

Expert advice

Never insert the tool less than $\frac{2}{3}$ of the collet length. We recommend tightening the clamping nuts with our TORCO-BLOCK or torque wrench.

For more information on TORCO-BLOCK, see page 262.

For tightening torque recommendations, please refer to page 293.

Instructions for correct clamping of tool shanks

Note

- // ER collet chucks – Exception: Toolholders with cylindrical shanks – are supplied without stop screws
- // Stop screws are supplied upon request
- // If ordering stop screw, specifying part no. (XXXX.XXXXX) and LOT no. (YYY). YYY of the toolholder is mandatory

Advice

- // Stop screws are used to secure tool shanks against axial displacement and may not be used as length adjustment screws
- // For trouble-free operation of the ER collet system, clamp tool shank first, then set stop screw
- // Incorrect handling of the stop screw may reduce runout accuracy and clamping force of the collet system
- // The use of stop screws may increase imbalance of the collet system

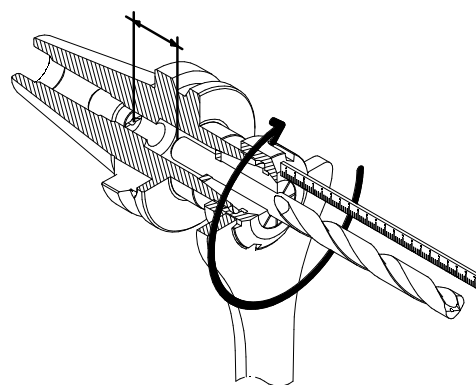

Set tool length with clearance to the stop screw, then clamp tool.

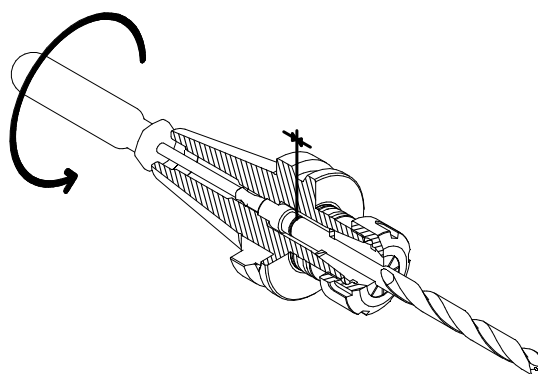

Apply stop screw to tool shank.

Increase collet and tool life

Optimize your surface finishes and extend tool life by minimizing occurring vibrations during machining.

Always assemble correctly

First, clip the collet in the nut. Second, insert the tool shank more than $\frac{2}{3}$ into the collet.

1.

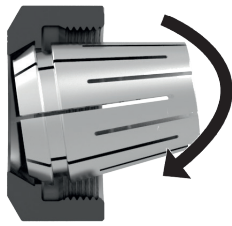

2.

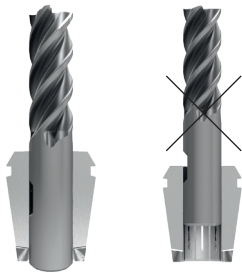

Listen to the click

Do not tighten the torque wrench further after the first click is heard.



Get your TORCO-FIX. Check page 258 for order details.

Only use REGO-FIX wrenches

To mount the collet in the toolholder please use one of these special wrenches- preferably the torque wrench, since it displays the amount of applied force.



Regular wrenches can also be used. Be aware that only the torque wrench will display the exact amount of applied force, making it the most exact tool to mount toolholders professionally.

Never use any extensions or hammers

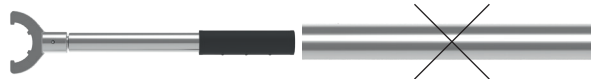

Recommended tightening torque for ER and MR clamping nuts

Maximum torques for retention knobs (Nm)

		Hi-Q®/ER clamping nuts												
		ER/ERC		ERB/ERBC		ERM/ERMC		ERMx/ERMxC		ERAx/ERAXC		ER MS		
		Collets [Nm]												
Collet size	Ø [mm]	Ø [decimal inch]	ER*	ER-GB	ER*	ER-GB	ER*	ER-GB	ER*	ER-GB	ER*	ER-GB	ER*	TORCO-FIX
ER 8 MB	0.2–0.9	0.0078–0.035	–	–	–	–	6	–	6	–	–	–	6	0
ER 8	1.0–5.0	0.039–0.196	–	–	–	–	6	–	6	–	–	–	6	0
ER 11 MB	0.2–0.9	0.0078–0.035	8	–	–	–	8	–	8	–	8	–	8	0, I
ER 11	1.0–2.9	0.039–0.098	8	8	–	–	8	8	8	8	8	8	10	0, I
	3.0–7.0	0.118–0.256	24	16	–	–	16	13	16	13	24	21	10	0, I
ER 16 MB	0.2–0.9	0.0078–0.035	8	–	–	–	8	–	8	–	8	–	12	0, I
ER 16	1.0	0.039	8	–	6.4	–	8	–	8	–	8	–	12	0, I
	1.5–3.5	0.059–0.138	20	–	16	–	20	–	20	–	20	–	20	0, I
	4.0–4.5	0.157–0.177	40	40	32	32	24	–	24	–	40	40	20	I, II
	5.0–10.0	0.197–0.394	56	44	56	44	24	–	24	–	40	40	20	II
ER 20	1.0	0.039	16	–	12	–	16	–	16	–	16	–	12	0, I
	1.5–6.5	0.059–0.256	32	32	24	24	28	28	28	28	52	35	20	I, II
	7.0–13.0	0.276–0.512	80	35	80	24	28	28	28	28	52	35	20	I, II
ER 25	1.0–3.5	0.059–0.138	24	–	20	–	24	–	24	–	24	–	–	I, II
	4.0–4.5	0.157–0.177	56	56	48	48	32	32	32	32	56	56	–	I, II
	5.0–7.5	0.196–0.295	80	80	72	72	32	32	32	32	80	80	–	II, III
	8.0–17.0	0.315–0.669	104	80	104	79	32	32	32	32	80	80	–	II, III
ER 32	2.0–2.5	0.078–0.098	24	24	20	–	–	–	–	–	24	–	–	I, II
	3.0–7.5	0.118–0.291	136	136	128	90	–	–	–	–	104	90	–	II, III
	8.0–22.0	0.315–0.787	136	136	136	90	–	–	–	–	104	90	–	II, III
ER 40	3.0–26.0	0.118–1.023	176	176	176	176	–	–	–	–	128	128	–	II, III
ER 50	6.0–36.0	0.236–1.417	240	300	240	300	–	–	–	–	–	–	–	III

*Includes ER standard and ER-UP

		micRun® clamping nuts							
		MR/MRC		MRM/MRMC					
		micRun® collets [Nm]							
Collet size	Ø [mm]	Ø [decimal inch]	MR	MRC	MRM	MRMC	Steep taper	maximum tightening torque	
MR 11	1.0–2.9	0.039–0.098	8	8	–	–	SK, BT, CAT 30	25 Nm	
	3.0–7.0	0.118–0.256	16	16	–	–	SK, BT, CAT 40	50 Nm	
MR 16	1.0	0.039	8	8	8	8	SK, BT, CAT 50	100 Nm	
	1.5–3.5	0.059–0.138	20	20	20	20			
	4.0–4.5	0.157–0.177	40	40	24	24			
	5.0–10.0	0.197–0.394	56	56	24	24			
MR 25	1.0–3.5	0.059–0.138	24	24	–	–			
	4.0–4.5	0.157–0.177	56	56	–	–			
	5.0–7.5	0.196–0.295	80	80	–	–			
	8.0–17.0	0.315–0.669	104	80	–	–			
MR 32	2.0–2.5	0.078–0.098	24	24	–	–			
	3.0–22.0	0.118–0.2917	136	136	–	–			

Higher tightening torques can lead to deformation of the steep taper!

Expert advice

We recommend tightening the clamping nuts with our TORCO-BLOCK or torque wrench.

Original REGO-FIX accessories can be found on page 237.

Recommended tightening torque for ER and MR clamping nuts

Maximum torques for retention knobs (ft-lbs)

		Hi-Q®/ER clamping nuts												
		ER/ERC		ERB/ERBC		ERM/ERMC		ERMx/ERMxC		ERAx/ERAxC		ER MS		
										Collets [ft-lbs]		Collets [ft-lbs]		
Collet size	Ø [mm]	Ø [decimal inch]	ER*	ER-GB	ER*	ER-GB	ER*	ER-GB	ER*	ER-GB	ER*	ER-GB	ER*	TORCO-FIX*
ER 8 MB	0.2–0.9	0.0078–0.035	–	–	–	–	4	–	4	–	–	–	4	Micro
ER 8	1.0–5.0	0.039–0.196	–	–	–	–	4	–	4	–	–	–	4	Micro
ER 11 MB	0.2–0.9	0.0078–0.035	6	–	–	–	6	–	6	–	6	–	6	Micro, S
ER 11	1.0–2.9	0.039–0.098	6	6	–	–	6	6	6	6	6	6	7	Micro, S
	3.0–7.0	0.118–0.256	24	16	–	–	16	13	16	13	24	21	7	Micro, S
ER 16 MB	0.2–0.9	0.0078–0.035	6	–	–	–	6	–	6	–	6	–	9	Micro, S
ER 16	1.0	0.039	6	–	5	–	6	–	6	–	6	–	9	Micro, S
	1.5–3.5	0.059–0.138	15	–	12	–	15	–	15	–	15	–	15	Micro, S
	4.0–4.5	0.157–0.177	30	30	25	25	18	–	18	–	30	30	15	S, M
	5.0–10.0	0.197–0.394	46	32	40	21	18	–	18	–	30	30	–	M
ER 20	1.0	0.039	12	–	10	–	12	–	12	–	12	–	9	Micro, S
	1.5–6.5	0.059–0.256	25	25	20	20	21	21	21	21	40	25	14	S, M
	7.0–13.0	0.276–0.512	60	60	60	60	21	21	21	21	40	25	14	S, M
ER 25	1.0–3.5	0.059–0.138	18	–	15	–	18	–	18	–	18	–	–	S, M
	4.0–4.5	0.157–0.177	40	40	35	35	24	24	24	24	40	40	–	S, M
	5.0–7.5	0.196–0.295	60	60	55	55	24	24	24	24	60	60	–	M, L
	8.0–17.0	0.315–0.669	80	60	80	60	24	24	24	24	60	60	–	M, L
ER 32	2.0–2.5	0.078–0.098	18	18	15	–	–	–	–	–	20	–	–	S, M
	3.0–7.5	0.118–0.291	100	100	95	65	–	–	–	–	80	65	–	M, L
	8.0–22.0	0.315–0.787	100	100	100	65	–	–	–	–	80	65	–	M, L
ER 40	3.0–26.0	0.118–1.023	130	130	130	130	–	–	–	–	95	95	–	M, L
ER 50	6.0–36.0	0.236–1.417	180	220	180	220	–	–	–	–	–	–	–	L

*Includes ER standard and ER-UP

Collet size	Ø [mm]	Ø [decimal inch]	micRun® clamping nuts				Steep taper	maximum tightening torque
			MR/MRC		MRM/MRMC			
			MR	MRC	MRM	MRMC		
MR 11	1.0–2.9	0.039–0.098	6	6	–	–	SK, BT, CAT 30	18 ft-lbs
	3.0–7.0	0.118–0.256	12	12	–	–	SK, BT, CAT 40	36-ft-lbs
MR 16	1.0	0.039	6	6	6	6	SK, BT, CAT 50	72 ft-lbs
	1.5–3.5	0.059–0.138	15	15	15	15		
	4.0–4.5	0.157–0.177	30	30	18	18		
	5.0–10.0	0.197–0.394	41	41	18	18		
MR 20	1.0	0.039	12	12	–	–		
	1.5–6.5	0.059–0.256	24	24	–	–		
	7.0–13.0	0.276–0.512	60	60	–	–		
MR 25	1.0–3.5	0.059–0.138	18	18	–	–		
	4.0–4.5	0.157–0.177	42	42	–	–		
	5.0–7.5	0.196–0.295	60	60	–	–		
	8.0–17.0	0.315–0.669	78	78	–	–		
MR 32	2.0–2.5	0.078–0.098	18	18	–	–		
	3.0–22.0	0.118–0.2917	100	100	–	–		

Higher tightening torques can lead to deformation of the steep taper and therefore to bad runout!

Expert advice

We recommend tightening the clamping nuts with our TORCO-BLOCK or torque wrench.

Original REGO-FIX accessories can be found on page 237.

ER collets dimensions

Size [mm]	Measurements [mm]										Drawing
D2	d	D1	D2	D3	D4	L	L1**	L2	L3	L4	
ER 8	1.0–2.5	8.5	8	6.5	4	13.6	2.98	1.2	1.5	6	1
ER 8	3.0–5.0	8.5	8	6.5	–	13.6	2.98	1.2	1.5	–	2
ER 11	1.0–2.5	11.5	11	9.5	5	18	3.8	2	2.5	9	3
ER 11	3.0–7.0	11.5	11	9.5	–	18	3.8	2	2.5	–	4
ER 16	1.0–1.59	17	16	13.8	7.5	27.5	6.26	2.7	4	13	3
ER 16	2.0–4.76	17	16	13.8	7.5	27.5	6.26	2.7	4	10	3
ER 16	5.0–10.0	17	16	13.8	–	27.5	6.26	2.7	4	–	4
ER 16	9.5–10.0	17	16	13.8	–	26*	6.26	2.7	4	–	4
ER 20	1.0–1.59	21	20	17.4	9	31.5	6.36	2.8	4.8	16	3
ER 20	2.0–6.50	21	20	17.4	9	31.5	6.36	2.8	4.8	13	3
ER 20	7.0–13.0	21	20	17.4	–	31.5	6.36	2.8	4.8	–	4
ER 25	1.0–1.59	26	25	22	12	34	6.66	3.1	5	18	3
ER 25	2.0–7.50	26	25	22	12	34	6.66	3.1	5	15	3
ER 25	8.0–17.0	26	25	22	–	34	6.66	3.1	5	–	4
ER 32	2.0–4.76	33	32	29.2	15	40	7.16	3.6	5.5	20	3
ER 32	5.0–7.5	33	32	29.2	15	40	7.16	3.6	5.5	15	3
ER 32	8.0–22.0	33	32	29.2	–	40	7.16	3.6	5.5	–	4
ER 40	3.0–4.76	41	40	36.2	20	46	7.66	4.1	7	24	3
ER 40	5.0–8.5	41	40	36.2	20	46	7.66	4.1	7	18	3
ER 40	9.0–30.0	41	40	36.2	–	46	7.66	4.1	7	–	4
ER 50	6.0–10.0	52	50	46	20	60	12.6	5.5	8.5	32	3
ER 50	12.0–36.0	52	50	46	–	60	12.6	5.5	8.5	–	4

*Up to 27.5 available, depending on production

**L1 references to the top length of the ER collet in the toolholder.

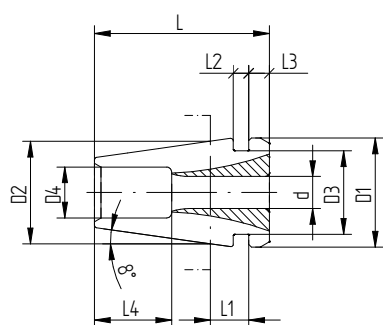

Drawing 1

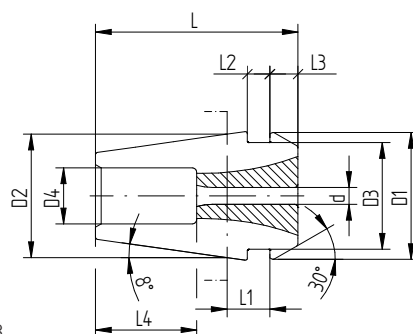

Drawing 3

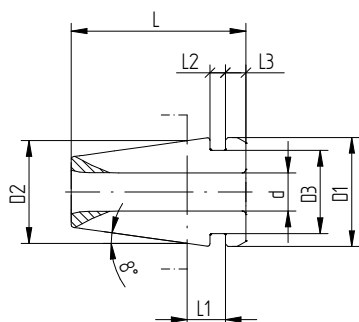

Drawing 2

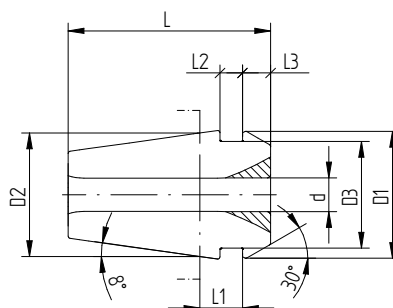

Drawing 4

MR collets dimensions

Size [mm]		Measurements [mm]									
D2	d	D1	D2	D3	D4	L	L1	L2	L3	L4	Drawing
MR 11	1.0 – 2.0	11.5	11	9.5	5	18	3.8	2	2.5	9	1
MR 11	3.0 – 6.35	11.5	11	9.5	–	18	3.8	2	2.5	–	2
MR 16	1.0	17	16	13.8	7.5	27.5	6.26	2.7	4	13	1
MR 16	2.0 – 4.0	17	16	13.8	7.5	27.5	6.26	2.7	4	10	1
MR 16	5.0 – 10.0	17	16	13.8	–	26*	6.25	2.7	4	–	2
MR 25	1.0	26	25	22	12	34	6.66	3.1	5	18	1
MR 25	2.0 – 6.35	26	25	22	12	34	6.66	3.1	5	15	1
MR 25	8.0 – 16.0	26	25	22	–	34	6.66	3.1	5	–	2
MR 32	2.0 – 4.0	33	32	29.2	15	40	7.2	3.6	5.5	20	1
MR 32	5.0 – 6.35	33	32	29.2	15	40	7.2	3.6	5.5	15	1
MR 32	8.0 – 20.0	33	32	29.2	–	40	7.2	3.6	5.5	–	2

*Up to 27.5 available, depending on production

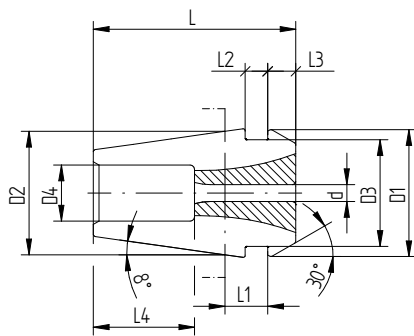

Drawing 1

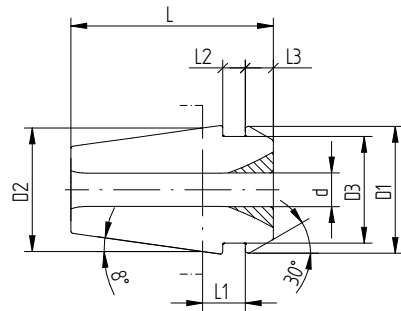

Drawing 2



REGO

REGO-FIX

Dimensions for ER collet cavities in machine spindles and matching clamping nuts

ER size	Diameter range [mm]	Hi-Q®										Measurements [mm]				
		ER	ERC	ERB	ERBC	ERM	ERMC	ERMx	ERMxC	AX	AXC	A	B	C	E	F
11	0.5–7.0	•	•	–	–	–	–	–	–	–	–	7.5	11	M 14 x 0.75	17	10
16	0.5–10.0	•	•	•	•	–	–	–	–	–	–	10.5	16	M 22 x 1.5	22	13
20	0.5–13.0	•	•	•	•	–	–	–	–	–	–	13.5	20	M 25 x 1.5	26.5	13.5
25	0.5–17.0	•	•	•	•	–	–	–	–	–	–	18.0	25	M 32 x 1.5	29	14
32	1.0–22.0	•	•	•	•	–	–	–	–	–	–	23.5	32	M 40 x 1.5	34	16
40	2.0–30.0	•	•	•	•	–	–	–	–	–	–	30.5	40	M 50 x 1.5	38	17
50	4.0–36.0	•	•	•	•	–	–	–	–	–	–	38	50	M 64 x 2	48	24
<hr/>																
8	0.5–5.0	–	–	–	–	•	–	•	–	–	–	5.2	8	M 10 x 0.75	13	8
11	0.5–7.0	–	–	–	–	•	•	•	•	–	–	7.5	11	M 13 x 0.75	17	8.5
16	0.5–10.0	–	–	–	–	•	•	•	•	–	–	10.5	16	M 19 x 1	22	13
20	0.5–13.0	–	–	–	–	•	•	•	•	–	–	13.5	20	M 24 x 1	26.5	13.5
25	0.5–17.0	–	–	–	–	•	•	•	•	–	–	18	25	M 30 x 1	29	14
<hr/>																
11	0.5–7.0	–	–	–	–	–	–	–	–	•	–	7.5	11	M 18 x 1	23	7
16	0.5–10.0	–	–	–	–	–	–	–	–	•	•	10.5	16	M 24 x 1	32	10
20	0.5–13.0	–	–	–	–	–	–	–	–	•	•	13.5	20	M 28 x 1.5	37.5	11
25	0.5–17.0	–	–	–	–	–	–	–	–	•	•	18	25	M 32 x 1.5	41	12
32	1.0–22.0	–	–	–	–	–	–	–	–	•	•	23.5	32	M 40 x 1.5	48	12
40	2.0–30.0	–	–	–	–	–	–	–	–	•	•	30.5	40	M 50 x 1.5	54	16

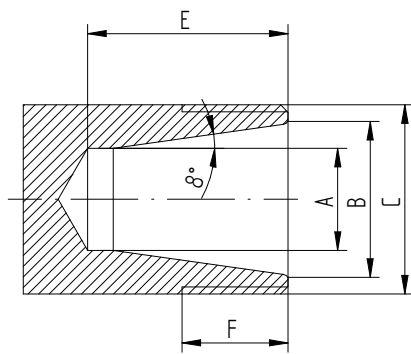

All other standard ER cavities

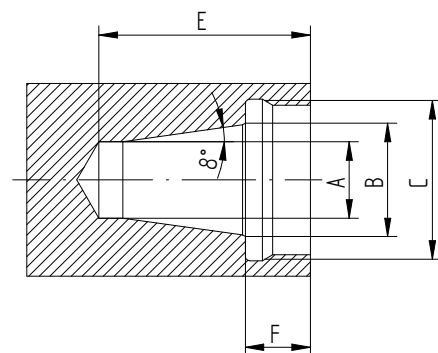

ER AX and ER AXC cavities

Technical information for tapping collets ER-GB

ER-GB

		ER 11-GB		ER 16-GB		ER 20-GB		ER 25-GB		ER 32-GB		ER 40-GB		ER 50-GB		
<i>x: not available</i>		L = 18.0 L1 = 2.0 D1 = 11.3 D2 = 11.0	L = 27.5 L1 = 2.7 D1 = 16.8 D2 = 16.0	L = 31.5 L1 = 2.8 D1 = 20.8 D2 = 20.0	L = 34.0 L1 = 3.1 D1 = 25.8 D2 = 25.0	L = 40.0 L1 = 3.6 D1 = 32.8 D2 = 32.0	L = 46.0 L1 = 4.1 D1 = 40.8 D2 = 40.0	L = 60.0 L1 = 8.75 D1 = 51.8 D2 = 51.0								
d	SW	L2	L3	D3	L3	D3	L3	D3	L3	D3	L3	D3	L3	D3	L3	D3
[mm]	[mm]	[mm]	[mm]	[mm]	[mm]	[mm]	[mm]	[mm]	[mm]	[mm]	[mm]	[mm]	[mm]	[mm]	[mm]	[mm]
2.5	2.1	12	2.8	4.0	x	x	x	x	x	x	x	x	x	x	x	x
2.8	2.1	12	2.8	4.0	x	x	x	x	x	x	x	x	x	x	x	x
3.5	2.7	14	1.8	4.5	x	x	x	x	x	x	x	x	x	x	x	x
4	3	14	-	-	x	x	x	x	x	x	x	x	x	x	x	x
4	3.15/ 3.2	ER 11=14 ER 16-32=15	-	-	4.8	7.5	9.8	9	11.8	12	17.8	15	x	x	x	x
4.5	3.4	ER 11=14 ER 16-32=15	-	-	4.8	7.5	9.8	9	11.8	12	17.8	15	x	x	x	x
5	4	ER 11=14 ER 16-32=18	-	-	4.8	7.5	9.8	9	11.8	12	17.8	15	x	x	x	x
5.5	4.3	18	-	-	4.8	7.5	9.8	9	11.8	12	17.8	15	x	x	x	x
5.5	4.5	18	-	-	4.8	7.5	9.8	9	11.8	12	17.8	15	x	x	x	x
6	4.5	18	-	-	4.8	7.5	8.8	9	10.8	12	16.8	15	22.8	20	x	x
6	4.9	ER 11=14 ER 16-40=18	-	-	4.8	7.5	8.8	9	10.8	12	16.8	15	22.8	20	x	x
6.2	5	18	x	x	4.8	7.5	8.8	9	10.8	12	16.8	15	22.8	20	x	x
6.3	5	18	x	x	4.8	7.5	8.8	9	10.8	12	16.8	15	22.8	20	x	x
7	5.5	18	x	x	3.8	8.0	7.8	9	9.8	12	15.8	15	21.8	20	x	x
7.1	5.6	18	x	x	3.8	8.0	7.8	9	9.8	12	15.8	15	21.8	20	x	x
8	6.2/ 6.3	22	x	x	-	-	2.8	10	4.8	12	10.8	15	16.8	20	x	x
8.5	6.5	22	x	x	-	-	2.8	10	4.8	12	10.8	15	16.8	20	x	x
9	7/ 7.1	22	x	x	-	-	2.8	10	3.8	12	9.8	15	15.8	20	x	x
10	8	25	x	x	x	x	-	-	-	-	6.8	15	12.8	20	x	x
10.5	8	25	x	x	x	x	-	-	-	-	6.8	15	12.8	20	x	x
11	9	25	x	x	x	x	-	-	-	-	5.8	15	11.8	20	x	x
11.2	9	25	x	x	x	x	-	-	-	-	5.8	15	11.8	20	x	x
12	9	25	x	x	x	x	-	-	-	-	5.8	15	11.8	20	x	x
12.5	10	25	x	x	x	x	x	x	-	-	4.8	15	10.8	20	x	x
14	11/ 11.2	25	x	x	x	x	x	x	-	-	3.8	17	9.8	20	x	x
15	12	25	x	x	x	x	x	x	-	-	3.8	17	9.8	20	x	x
16	12/ 12.5	25	x	x	x	x	x	x	-	-	2.8	18	8.8	20	x	x
17	13	25	x	x	x	x	x	x	x	x	2.8	19.5	8.8	20	x	x
18	14.5	25	x	x	x	x	x	x	x	x	2.8	21	7.8	21	x	x
20	16	28	x	x	x	x	x	x	x	x	2.8	21.5	3.8	22	x	x
22	18	ER 40 = 28 ER 50 = 41	x	x	x	x	x	x	x	x	-	-	3.8	24	x	x
25	20	41	x	x	x	x	x	x	x	x	x	x	-	-	-	-
28	22	41	x	x	x	x	x	x	x	x	x	x	x	x	-	-
32	24	41	x	x	x	x	x	x	x	x	x	x	x	x	-	-



Type	Measurements [mm]							
	d	D1	D2	L	L1	L2	L3	L4
PCM ET1-12	3.55	7	11.5	18	16.5	2.5	5	5.5
PCM ET1-16	6.3	11	17	22	20	2.8	7	7
PCM ET1-20	7.1	14	21	24	23	2.8	8	7
PCM ET1-25	10	19	26	26	24	3	10	8
PCM ET1-32	12.5	23	33	33	32	3	1	10
PCM ET1-40	17	28	41	42	42	3	12	13

Expert advice

Do not use for coolant through tools and for applications with sealing disks.

Technical information for microbore collets

Type	Measurements [mm]									
	d	D1	D2	D3	D4	L	L1	L2	L3	L4
ER 8-MB	0.2-0.9	8.5	8	6.5	4	13.5	1.2	1.2	1.5	6
ER 11-MB	0.2-0.9	11.5	11	9.5	5	18	2	2	2.5	9
ER 16-MB	0.2-0.9	17	16	13.8	7.5	27.5	6.3	2.7	4	13

Expert advice

ER-MB collets have no clamping range. Only nominal diameters h7 can be clamped.

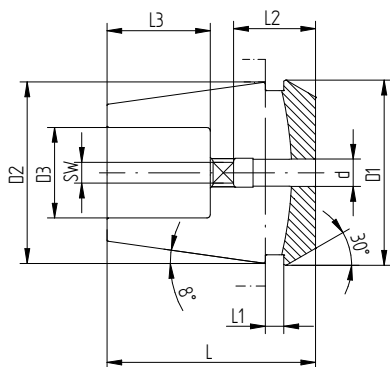

ER-GB, page 150

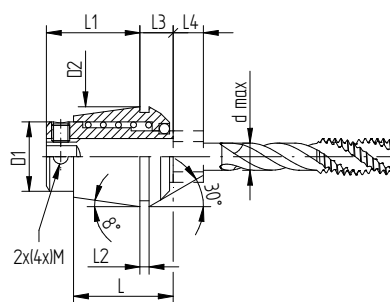

PCM ET1

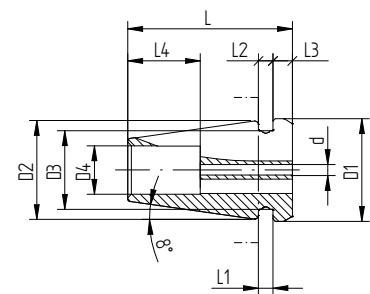

ER-MB

Reduction sleeves

HS

Type	Measurements [mm]						
	d	d	D1	D2	L1	L2	L3
HS 12 HS 12-CF							
Ø 3.0	3	–	12	16	40	29	4
Ø 1/8"	3.175	1/8	12	16	40	29	4
Ø 4.0	4	–	12	16	40	29	4
Ø 3/16"	4.763	3/16	12	16	40	29	4
Ø 5.0	5	–	12	16	40	29	4
Ø 6.0	6	–	12	16	40	36	4
Ø 1/4"	6.35	1/4	12	16	40	36	4
Ø 7.0	7	–	12	16	40	37	4
Ø 5/16"	7.938	5/16	12	16	40	37	4
Ø 8.0	8	–	12	16	40	37	4
Ø 9.0	9	–	12	16	40	37	4
Ø 3/8"	9.525	3/8	12	16	40	40	4
Ø 10.0	10	–	12	16	40	40	4
HS 12-MB							
Ø 1.0	1	–	12	16	40	20	4
Ø 1.5	1.5	–	12	16	40	20	4
Ø 2.0	2	–	12	16	40	20	4
Ø 2.5	2.5	–	12	16	40	20	4
HS 20 HS 20-CF							
Ø 3.0	3	–	20	25	50	28	4
Ø 1/8"	3.175	1/8	20	25	50	28	4
Ø 4.0	4	–	20	25	50	28	4
Ø 3/16"	4.763	3/16	20	25	50	28	4
Ø 5.0	5	–	20	25	50	28	4
Ø 6.0	6	–	20	25	50	36	4
Ø 1/4"	6.35	1/4	20	25	50	36	4
Ø 7.0	7	–	20	25	50	38	4
Ø 5/16"	7.938	5/16	20	25	50	37	4
Ø 8.0	8	–	20	25	50	37	4
Ø 9.0	9	–	20	25	50	38	4
Ø 3/8"	9.525	3/8	20	25	50	36	4
Ø 10.0	10	–	20	25	50	40	4
Ø 11.0	11	–	20	25	50	40	4
Ø 12.0	12	–	20	25	50	45	4
Ø 1/2"	12.7	1/2	20	25	50	45	4
Ø 13.0	13	–	20	25	50	45	4
Ø 14.0	14	–	20	25	50	45	4
Ø 15.0	15	–	20	25	50	45	4
Ø 5/8"	15.875	5/8	20	25	50	48	4
Ø 16.0	16	–	20	25	50	48	4

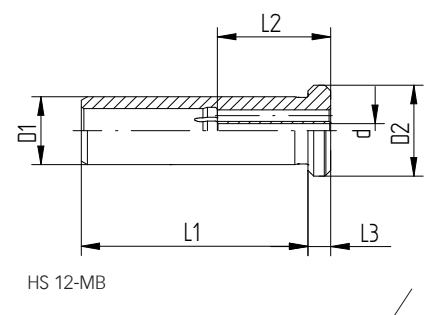
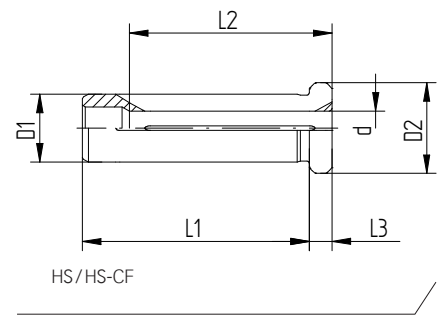

Type	Measurements [mm]						
	d	d	D1	D2	L1	L2	L3
HS 25							
Ø 3.0	3	–	25	30	56	29	4
Ø 1/8"	3.175	1/8	25	30	56	29	4
Ø 4.0	4	–	25	30	56	29	4
Ø 3/16"	4.763	3/16	25	30	56	29	4
Ø 5.0	5	–	25	30	56	29	4
Ø 6.0	6	–	25	30	56	37	4
Ø 1/4"	6.35	1/4	25	30	56	37	4
Ø 7.0	7	–	25	30	56	37	4
Ø 5/16"	7.938	5/16	25	30	56	37	4
Ø 8.0	8	–	25	30	56	37	4
Ø 9.0	9	–	25	30	56	38	4
Ø 3/8"	9.525	3/8	25	30	56	38	4
Ø 10.0	10	–	25	30	56	40	4
Ø 7/16"	11.112	7/16	25	30	56	40	4
Ø 12.0	12	–	25	30	56	46	4
Ø 1/2"	12.7	1/2	25	30	56	46	4
Ø 14.0	14	–	25	30	56	47	4
Ø 9/16"	14.288	9/16	25	30	56	47	4
Ø 5/8"	15.875	5/8	25	30	56	48	4
Ø 16.0	16	–	25	30	56	48	4
Ø 11/16"	17.461	11/16	25	30	56	48	4
Ø 18.0	18	–	25	30	56	48	4
Ø 3/4"	19.05	3/4	25	30	56	48	4
Ø 20.0	20	–	25	30	56	50	4
Ø 13/16"	20.638	13/16	25	30	56	50	4

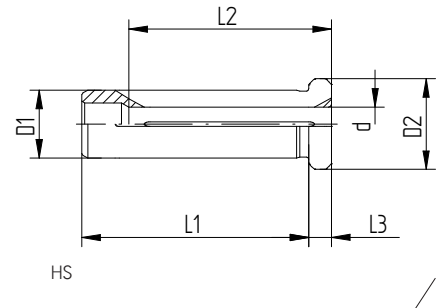

Expert advice

Reduction sleeve may be damaged, if clamped without a tool.

Reduction sleeves

HS

Type	Measurements [mm]						
	d	d	D1	D2	L1	L2	L3
HS 32 HS 32-CF							
Ø 3/16"	4.763	3/16	32	36	60	29	4
Ø 5.0	5	-	32	36	60	29	4
Ø 6.0	6	-	32	36	60	36	4
Ø 1/4"	6.35	1/4	32	36	60	36	4
Ø 7.0	7	-	32	36	60	37	4
Ø 5/16"	7.938	5/16	32	36	60	36	4
Ø 8.0	8	-	32	36	60	36	4
Ø 9.0	9	-	32	36	60	37	4
Ø 3/8"	9.525	3/8	32	36	60	37	4
Ø 10.0	10	-	32	36	60	40	4
Ø 11.0	11	-	32	36	60	40	4
Ø 7/16"	11.112	7/16	32	36	60	45	4
Ø 12.0	12	-	32	36	60	45	4
Ø 1/2"	12.7	1/2	32	36	60	45	4
Ø 13.0	13	-	32	36	60	45	4
Ø 14.0	14	-	32	36	60	46	4
Ø 9/16"	14.288	9/16	32	36	60	46	4
Ø 15.0	15	-	32	36	60	46	4
Ø 5/8"	15.875	5/8	32	36	60	46	4
Ø 16.0	16	-	32	36	60	48	4
Ø 17.0	17	-	32	36	60	48	4
Ø 11/16"	17.461	11/16	32	36	60	48	4
Ø 18.0	18	-	32	36	60	49	4
Ø 19.0	19	-	32	36	60	49	4
Ø 3/4"	19.05	3/4	32	36	60	50	4
Ø 20.0	20	-	32	36	60	50	4
Ø 13/16"	20.638	13/16	32	36	60	50	4
Ø 22.0	22	-	32	36	60	50	4
Ø 7/8"	22.225	7/8	32	36	60	50	4
Ø 15/16"	23.813	15/16	32	36	60	52	4
Ø 25.0	25	-	32	36	60	56	4
Ø 1"	25.4	1	32	36	60	56	4

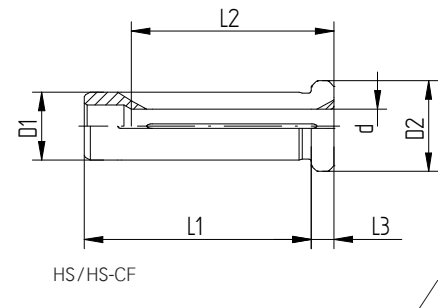

Spindle interface norms

HSK	SK	BT	CAPTO
DIN 69893	DIN 69871	MAS 403	ISO 26623

Type	Measurements [mm]					G
	D1	D2	L1	L2	L3	
HSK DIN 69893						
HSK-A 25	25	19	10	13	2.5	-
HSK-C 25	25	19	8	13	2.5	-
HSK-E 25	25	19	10	13	2.5	-
HSK-A 32	32	24	20	16	3.2	-
HSK-C 32	32	24	10	16	3.2	-
HSK-E 32	32	24	20	16	3.2	-
HSK-A 40	40	30	20	20	4	-
HSK-C 40	40	30	10	20	4	-
HSK-E 40	40	30	20	20	4	-
HSK-A 50	50	38	26	25	5	-
HSK-C 50	50	38	12.5	25	5	-
HSK-E 50	50	38	26	25	5	-
HSK-F 50	50	30	26	20	4	-
HSK-A 63	63	48	26	32	6.3	-
HSK-C 63	63	48	12.5	32	6.3	-
HSK-E 63	63	48	26	32	6.3	-
HSK-F 63	63	38	26	25	5	-
HSK-A 80	80	60	26	40	8	-
HSK-C 80	80	60	16	40	8	-
HSK-F 80	80	48	26	32	6.3	-
HSK-A 100	100	75	29	50	10	-
HSK-C 100	100	75	16	50	10	-
HSK-E 100	100	70	29	50	10	-
SK DIN 69871						
SK 30	31.75	50	3.2	47.8	15.85	M 12
SK 40	44.45	63.55	3.2	68.4	15.85	M 16
SK 50	69.85	97.5	3.2	101.75	15.85	M 24
BT MAS 403						
BT 30	31.75	46	2	48.4	20	M 12
BT 40	44.45	63	2	65.4	25	M 16
BT 50	69.85	100	3	101.8	35	M 24
Polygon shank CAPTO ISO 26623						
Polygon shank C3	32	-	15	19	-	M 12 x 1.5
Polygon shank C4	40	-	20	24	-	M 14 x 1.5
Polygon shank C5	50	-	20	30	-	M 16 x 1.5
Polygon shank C6	63	-	22	38	-	M 20 x 2
Polygon shank C8	80	-	30	48	-	M 20 x 2

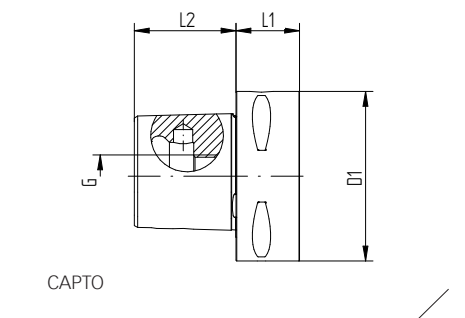
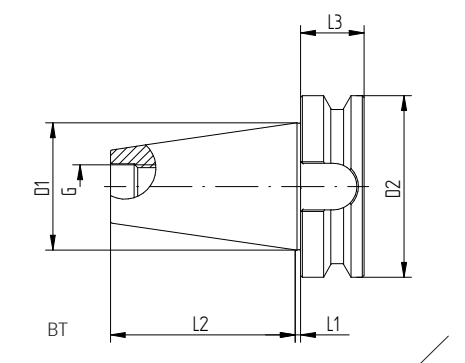
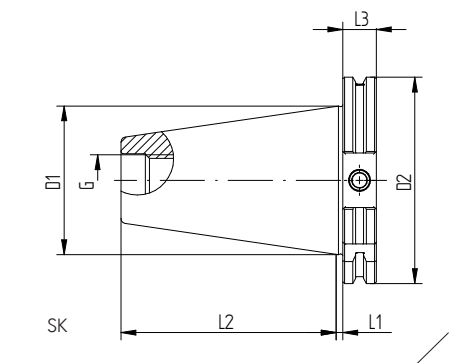
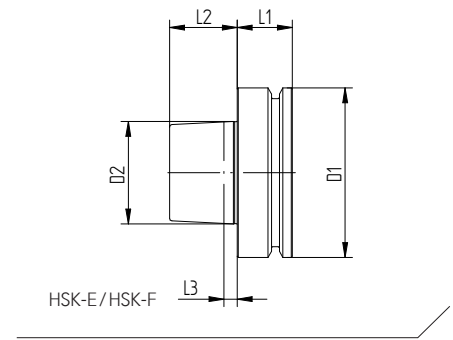
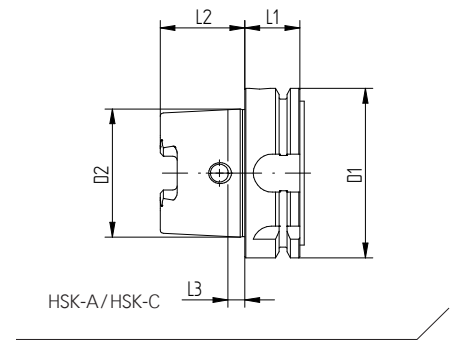

HSK forms and their key characteristics

HSK

DIN 69893

ISO 12164

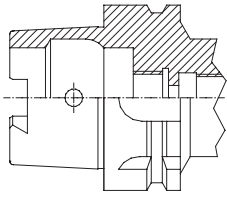

Form A*

- // Standard type for machining centers and milling machines
- // For automatic tool change
- // Coolant supply through center via coolant tube
- // Drive keys at the end of HSK taper
- // Hole for data carrier DIN STD 69873 in the flange is available on request

**Also usable in form C applications with side hole for manual tool change*

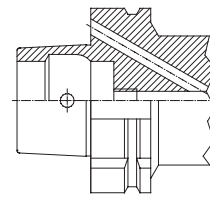

Form B

- // For machining centers, milling and turning machines
- // With enlarged flange size for higher radial rigidity
- // For automatic tool change
- // Coolant supply through the flange
- // Drive keys at the flange

Available on request

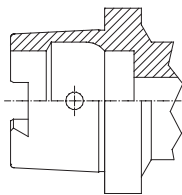

Form C

- // For transfer lines, special machines and modular tooling systems
- // For manual tool change
- // Drive keys at the end of HSK taper

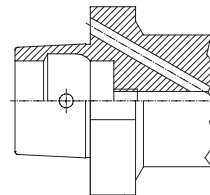

Form D

- // For special machines
- // With enlarged flange size for higher radial rigidity
- // For manual tool change
- // Coolant supply through the flange
- // Drive keys at the flange

Available on request

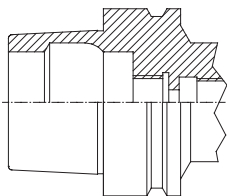

Form E

- // For high-speed applications
- // For automatic tool change
- // Coolant supply through center via coolant tube
- // Without any drive keys for absolute symmetry

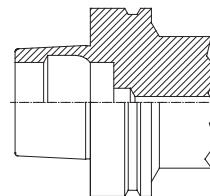

Form F

- // For high-speed applications
- // With enlarged flange size for higher radial rigidity
- // For automatic tool change
- // Without any drive keys for absolute symmetry

HSK interface

HSK
DIN 69893
ISO 12164

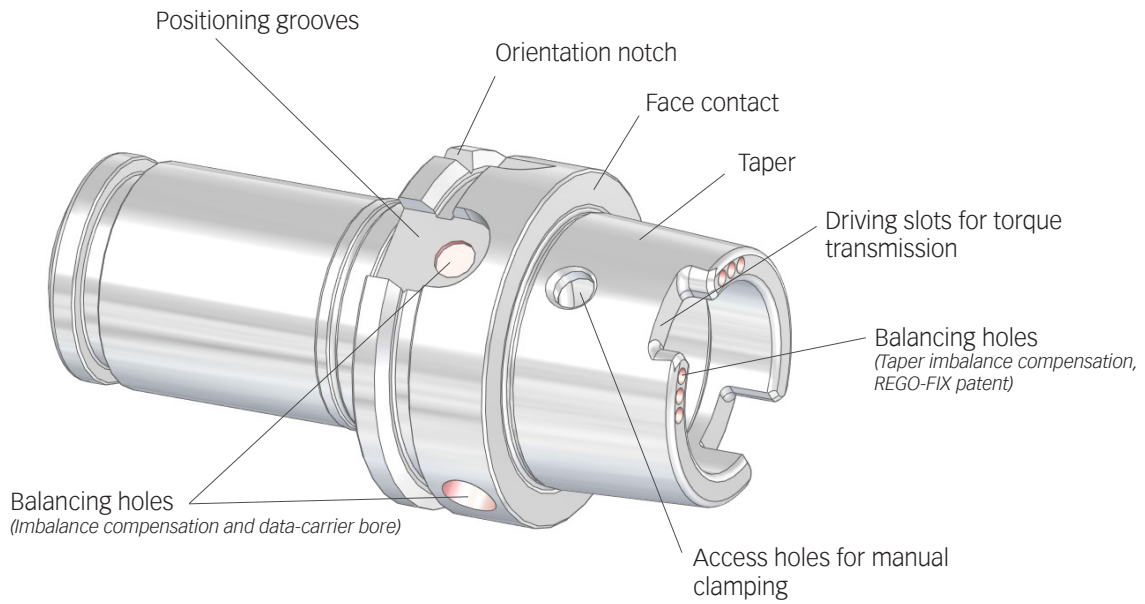

Position with unclamped HSK toolholder

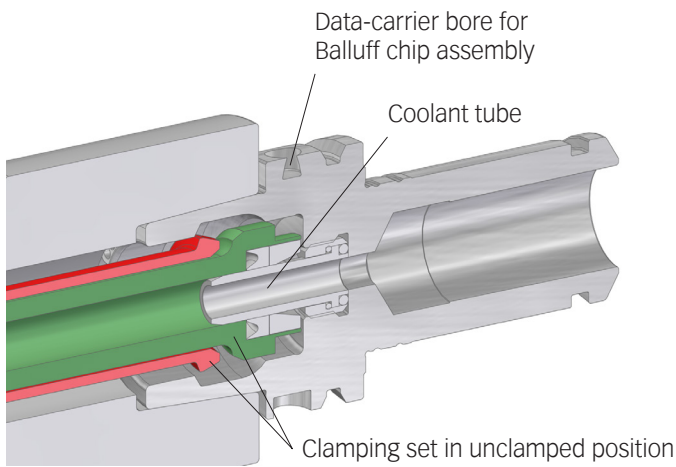

Position with clamped HSK toolholder

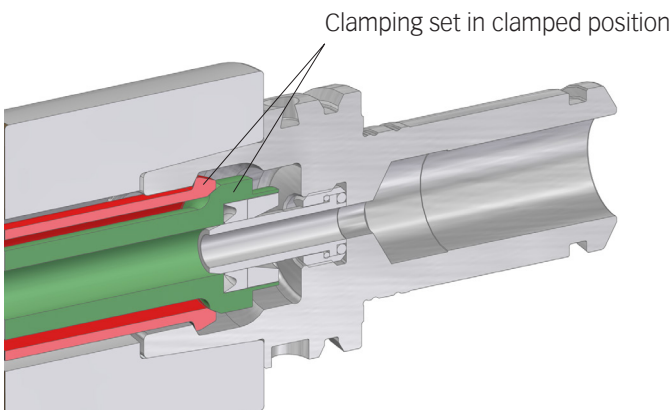

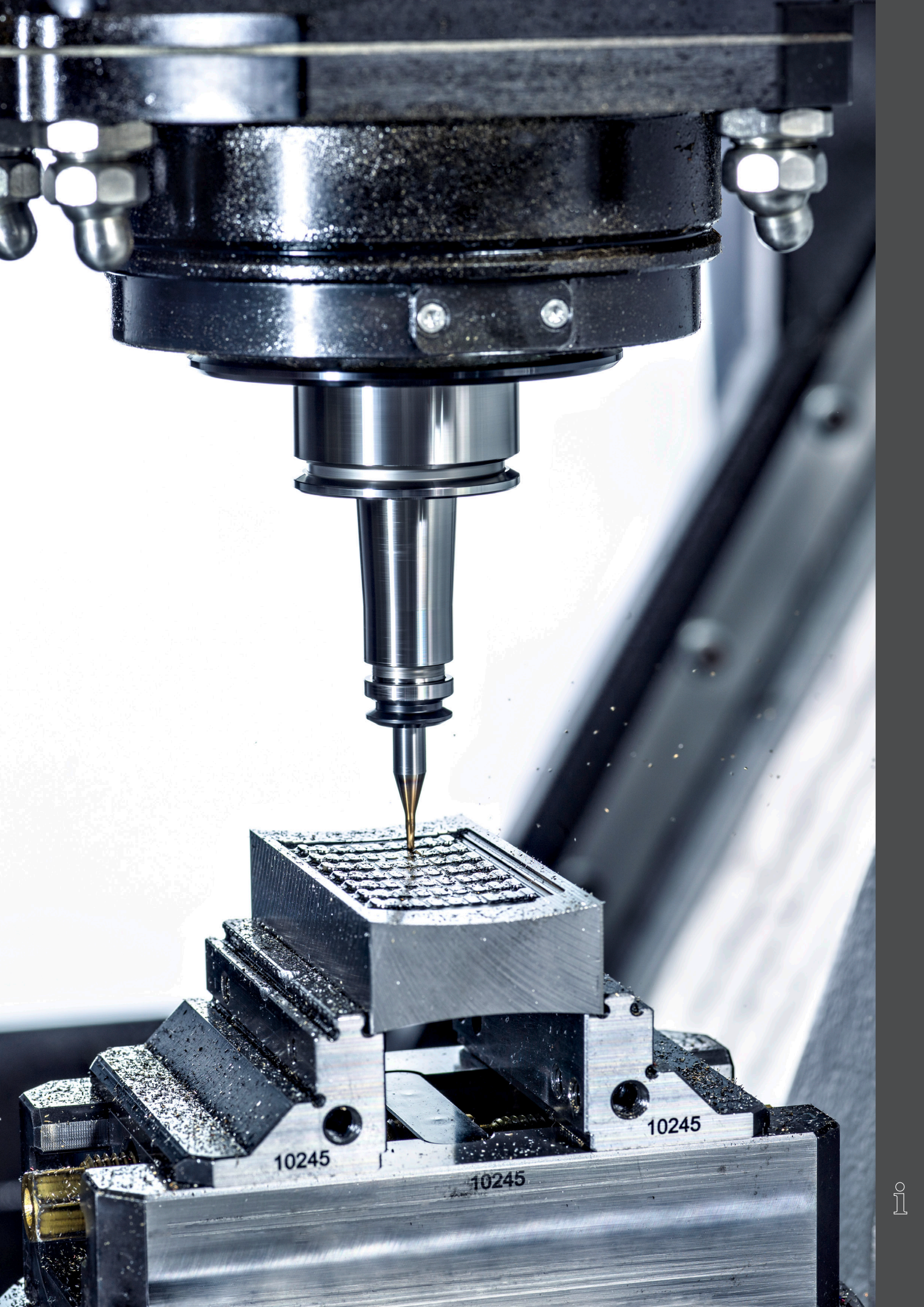

10245

10245

10245

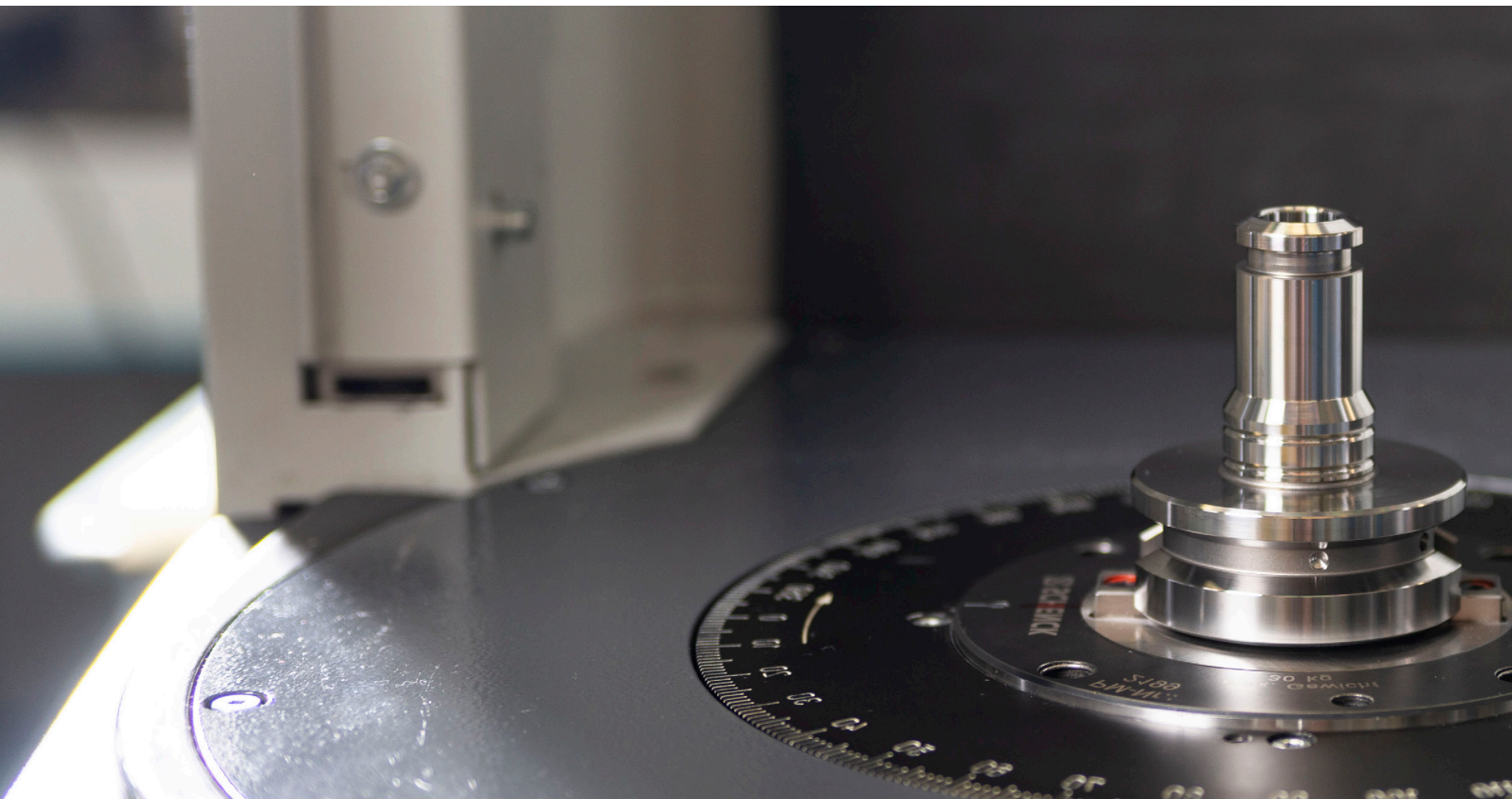

Balancing

The experience of REGO-FIX in the development and manufacturing of tool holding systems has provided us a large knowledge basis on the subject of balancing.

In our production we have the latest manufacturing equipment and testing methods available, but as with other manufacturers the physical limits of balancing have to be considered. Furthermore, it has to be considered whether a process is economically feasible and the imbalance measurable. The weights and interaction of the individual components of the tool holding system determines which options for balancing are practical. Therefore, we recommend that the entire assembly be considered as a whole, as it is stipulated in the DIN 69888.

What is imbalance Imbalance occurs when the mass of a rotating body is not distributed rotationally symmetric. This leads to vibration and can cause increased wear or damage to cutting tools and or machine bearing components. The weight of each part of the tool holding system is critical to the question: At what speed is balancing economically producible? Speeds have a great influence on the centrifugal forces. Due to its nature the centrifugal force increase exponentially, which means when you double the speed you get four times the centrifugal force.

Static imbalance A static unbalance results when the axis of rotation does not pass through the center of gravity axis of the rotary body. The axis of rotation is parallel to the axis of gravity, but is displaced by some amount. This displacement (called eccentricity) produces a rotational circular vibration perpendicular to the rotational axis. This imbalance can be measured in a stationary position.

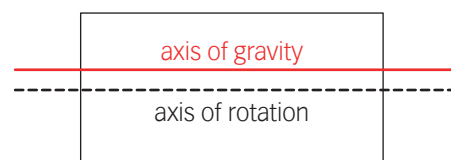

To reduce a static imbalance an appropriate weight is removed or adjusted perpendicular to the rotational axis.

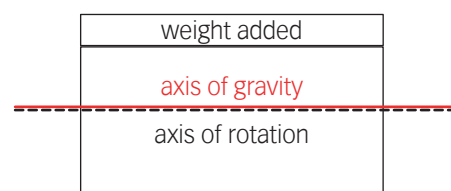

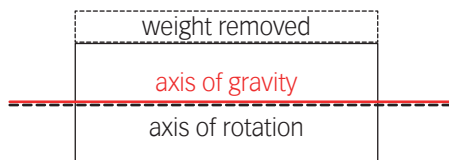

To balance a dynamic imbalance, weight added, removed or adjusted at two levels.

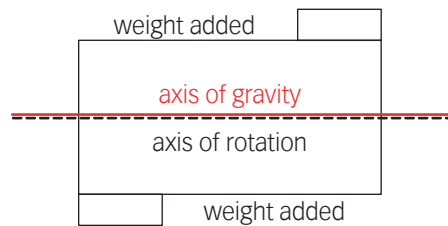

Dynamic imbalance Dynamic imbalance occurs only during operation. It manifests itself in an unbalanced moment on the axis of rotation producing coupled forces and orbital oscillations. The center of gravity of the rotating body is in the rest position, while the axis for the coupled forces rotates in circular motions.

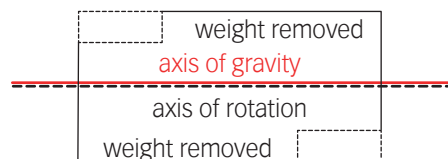
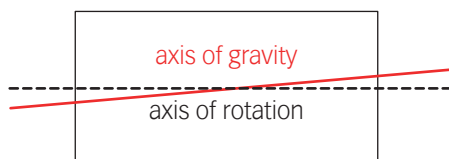

Influences on the imbalance

The whole toolholding system and spindle should be considered as well as any external influences such as dried-coolant film or dirt that has collected on the spindle. The weight of the individual components and the speeds are important factors to consider as well.

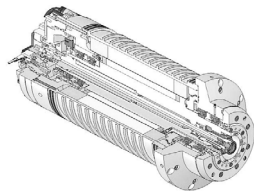

Machine spindle

The spindle rotors are supported in the spindle housing in several locations and have for the most part a weight of about 15 kg. Therefore, they can be balanced much more accurately than a small rotating body such as a toolholder of only 200 g.

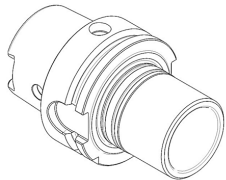

Toolholder

The toolholder is the largest component in the interface between the spindle and the tool. These are balanced according to the manufacturer at the factory.

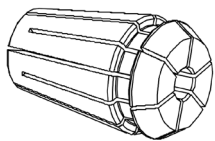

Collet

These are usually rotationally symmetrical parts and do not have to be balanced. Installation error (eg. not correct clamping) or pollution (chips, dried coolant etc.) can cause an imbalance.



Clamping nut

These are balanced according to manufacturer. Dirt, debris or damage can cause an imbalance.

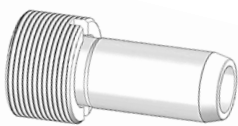

Accessories for clamping system

Accessories, such as coolant tubes, stop screws, pull studs, sealing and cooling disks may cause an additional imbalance.



Tool

Cutting tool design may (eg, single-edged, Weldon clamping surface, etc.) already have an imbalance.

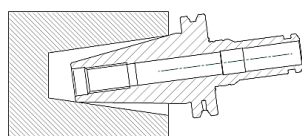

Positioning error/Taper fit

The tool change position accuracy of toolholders can play a large role in the balancing and repeatability of the measured imbalance. An HSK holder has a position repeatability of between 2-4 microns while most steep taper holders can be up to 5 microns. Impurities on the cone or on the mating surface between the toolholder and the spindle can also lead to an imbalance and larger position inaccuracies. So as can be seen it is very important to clean all surfaces thoroughly as to minimize the position error that can occur.

Balancing quality

In recent years the cutting speeds have increased because of better materials and processes. This has resulted in new requirements on the balance of the whole system (machine spindle, clamping tool and tool).

General informations can be read in the Norm DIN ISO 19499:2008-03 "Mechanical vibration – Balancing – Guidance on the use and application of balancing standards".

Norms

Selection of DIN ISO 1940

This standard specifies the requirements on balancing as regulated grades of rotors in a constant (rigid) state. This standard is not applicable for tooling systems for the following reasons entire.

Spindles, tool holder systems and cutting tools have, in contrast to other rigid rotors (such as electric motor armatures, etc.) essential differences:

- Spindle, tool holder and cutting tool form a system with high temporal variation (for example, frequent tool change machining centers).
- Due to the radial angle and tension-related inaccuracies a repeated change of tool in the spindle leads to a change in the balancing state of the entire system.
- Fit tolerances of individual components (spindle, tool holder and cutting tool) set limits for balancing.

Selection of DIN 69888:2008-09

This standard specifies balancing requirements for tooling systems with HSK 25 to HSK 100 according to DIN 69063-1, DIN 69063-2, DIN 69063-5, DIN 69063-6, DIN 69893-1, DIN 69893-2, DIN 69893-5 and DIN 69893-6 firmly based on their particular operating speed. In this standard the HSK 125 and HSK 160 are not given any consideration, so it is recommended to apply the limits for HSK 100. Correspondingly, the standard tool for systems with interfaces and tapers such as ABS, CAPTO, KM, SK and cylindrical shank are used. Here, the type-specific aspects of the interfaces and holders are taken into account.

The standard applies under the following conditions:

- In the area of operating speeds the tool systems are considered to be rigid.
- The limit of vibration mechanical stress is defined by the permissible bearing load of the machine spindle.
- So as not to unbalance-related impairments in the production is given in compliance with the procedures specified in the standard requirements (load bearing and thus the vibration velocity).

Importance of balance of quality

By balancing quality value G, the weight of the rotor (M), the speed (n) and the conversion factor (9549), the permissible residual unbalance U_{zul} is calculated in gmm. It tells us how much mass asymmetrically distributed in the radial direction from the axis of rotation is still permissible. With the calculated value, the distance of this mass may be recalculated to gravitational axis.

Formulas

$$G = e \times w = \frac{U}{M} \times \frac{2 \times \pi \times n}{60} = \frac{U \times \pi \times n}{M \times 30}$$

$$\text{result} \quad U = \frac{G \times M \times 30}{\pi \times n}$$

$$\text{Conversion factor} = 9.549$$

$$U_{zul} = \frac{G \times M \times 9.549}{n}$$

$$e_{zul} = \frac{U_{zul}}{M}$$

$$u = \frac{U_{zul}}{R}$$

U = Unbalance of the rotor (gmm)
G = Balance quality (mm/s)

M = Weight of the rotor (g)
n = Speed of the rotors (1/min)

e = Eccentricity of gravity (µm)
w = Angular speed (1/sec)

U_{zul} = Permitted residual unbalance of the rotor (gmm)
 e_{zul} = Permitted eccentricity (µm)

u = Unbalance mass on the largest outer radius (g)

R = Radius at which the balancing is done (mm)

Comparison

The comparison between the overall system and a single toolholder demonstrates that the balance of the individual component has a very small effect on the overall system.

Overall system

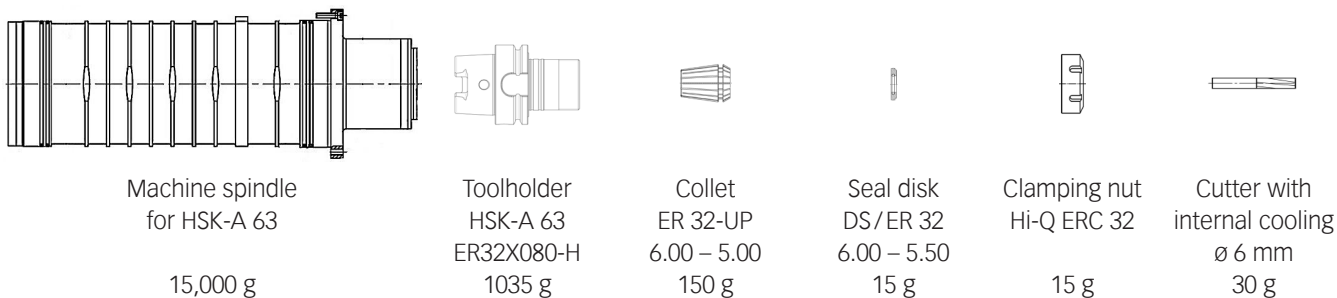

Machine spindle for HSK-A 63	15,000 g	Toolholder HSK-A 63 ER32X080-H	1035 g	Collet ER 32-UP 6.00 – 5.00	150 g	Seal disk DS/ER 32 6.00 – 5.50	15 g	Clamping nut Hi-Q ERC 32	15 g	Cutter with internal cooling ø 6 mm	30 g
Weight	16398 g										
Radius (R)	31.5 mm										
Speed	10,000 min ⁻¹					42,000 min ⁻¹					
Balance quality (G)	2.5					2.5					
Permitted residual unbalance (U _{zul})	39.146 gmm					9.321 gmm					
Permitted eccentricity (e _{zul})	2.387 µm					0.568 µm					

$$U_{zul10000} = \frac{2.5 \times 16,398 \times 9.549}{10,000} = 39.146 \text{ gmm}$$

$$e_{zul10000} = \frac{39.146}{16,398} = 2.387 \text{ µm}$$

$$U_{10000} = \frac{39.146}{31.5} = 1.2 \text{ g}$$

$$U_{zul42000} = \frac{2.5 \times 16,398 \times 9.549}{42,000} = 9.321 \text{ gmm}$$

$$e_{zul42000} = \frac{9.321}{16,398} = 0.568 \text{ µm}$$

$$U_{42000} = \frac{9.321}{31.5} = 0.3 \text{ g}$$

By calculation the entire system is allowed 1.2 g at 10,000 min⁻¹ and 0.3 g at 42,000 min⁻¹ and the permissible unbalanced mass is at its greatest diameter (in this case the spindle rotor). The following calculation is used to demonstrate how little unbalanced mass of a toolholder HSK-A 63/ER32 x 080 is acceptable in comparison to the overall system:

Weight	1035 g	
Radius (R)	31.5 mm	
Speed	10,000 min ⁻¹	42,000 min ⁻¹
Balance quality (G)	2.5	2.5
Permitted residual unbalance (U _{zul})	2.471 gmm	0.588 gmm
Permitted eccentricity (e _{zul})	2.387 µm	0.568 µm

$$U_{zul10000} = \frac{2.5 \times 1035 \times 9.549}{10,000} = 2.471 \text{ gmm}$$

$$e_{zul10000} = \frac{2.471}{1035} = 2.380 \text{ µm}$$

$$U_{10000} = \frac{2.471}{31.5} = 0.078 \text{ g}$$

$$U_{zul42000} = \frac{2.5 \times 1035 \times 9.549}{42,000} = 0.588 \text{ gmm}$$

$$e_{zul42000} = \frac{0.588}{1035} = 0.568 \text{ µm}$$

$$U_{42000} = \frac{0.588}{31.5} = 0.019 \text{ g}$$

If now the allowable imbalance masses are compared, it is evident that in the overall system may be about 15 times larger than in the toolholder alone. The current state of balancing technology is not economically producible when just looking at the toolholder, but when the entire system is considered it may not necessary. An imbalance caused by positioning error can't be corrected or accounted for.

Balancing at REGO-FIX

All toolholders and clamping nuts from the production of REGO-FIX are balanced at the factory by design. In addition, the toolholders are fine balanced and 100% customized. The balancing data refer only to the toolholder. Most REGO-FIX toolholders are designed to accommodate the REGO-FIX Hi-Q® balancing rings for fine balancing when required.

Fine balance with Hi-Q® balancing rings

REGO-FIX Hi-Q® balancing rings (patented) are mounted on the grooves designed into the toolholder, making all the clamping system (holder, nut, tool, etc.) balanceable.

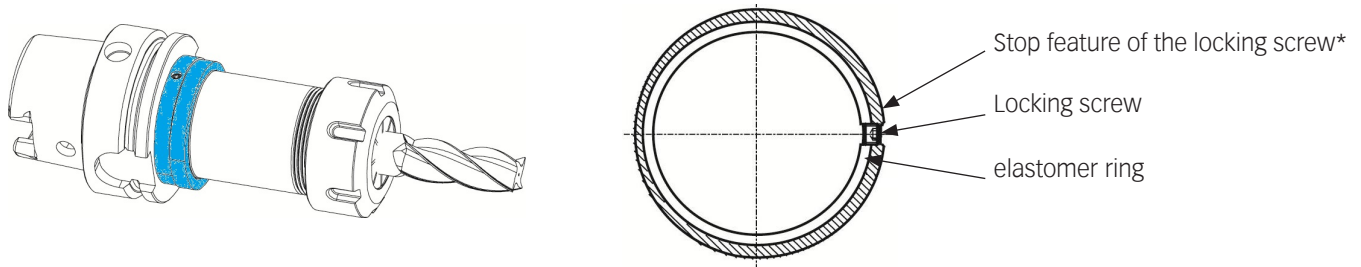

**The locking set screw has a feature that prevents it from backing out and being thrown into the machine, which can at high speeds and the resulting centrifugal forces cause serious injury and damage to machinery.*

Details of the balance values of toolholders

The stated REGO-FIX balance values (noted in packaging, catalogs, brochures, etc.) are the actual measured values from the state-of-the-art-balancers.

Toolholder

These toolholders are under production on a Level (static) as standard balanced at:

G 2.5 @ 25,000 min ⁻¹	SK 40 BT 40 CAT 40 SK 50 BT 50 CAT 50 CAT 50+ CAT 40+ BT 50+ BT 40+ HSK 100 HSK 125 HSK 80 HSK 63 Capto (C3, C4, C5, C6, C8)
balanced to 30,000 min ⁻¹	BT 30 SK 30 CAT 30 BT 30+ BT-OM 30
balanced to 33,000 min ⁻¹	HSK 80 F HSK 80 FP
balanced to 36,000 min ⁻¹	HSK 50
balanced to 45,000 min ⁻¹	HSK 40
balanced to 50,000 min ⁻¹	ISO 20 (HAAS) HSK 32-25/PG 6 x 046
balanced to 60,000 min ⁻¹	HSK 32
balanced to 90,000 min ⁻¹	HSK 20/HSK 25
G 2.5 @ 5,000 min ⁻¹	all XL toolholders

HSK – Toolholder

These toolholders are balanced by a special process (Pat. pend.), in which two axially spaced staggered levels material ablated.

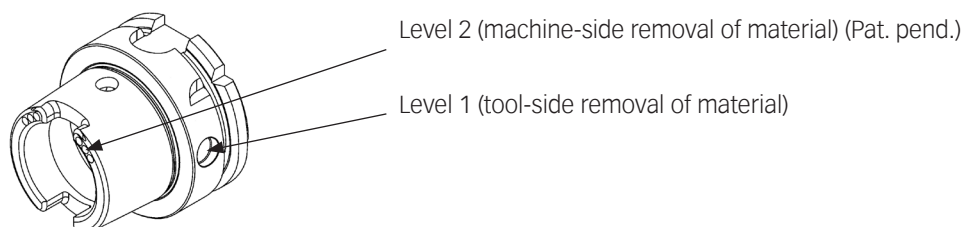

*Other balance qualities are available on request at an additional cost. It can't be guaranteed that these values are reproducible due to positioning error and taper fit. See the section on Positioning Error and Taper Fit for more details, page 315.

Hi-Q® – Clamping nut

The REGO-FIX-Hi-Q® clamping nuts are balanced due to its design (patented) and are continuously tested during production.

Collets

Collets are rotationally symmetric and do not require balancing. To enable the best possible concentricity collets must be cleaned before each use.

Accessories (sealing disks, coolant disks, etc.)

These are rotationally symmetric and do not require balancing. To enable the best possible concentricity the accessories must be cleaned before each use. By improper handling or installation can lead to imbalance.

Interpreting the DIN 69888:2008-09

The accuracy of balancing machines is only partially dependent on the tool mass, i.e. for small tool masses (< 1,5kg), the inaccuracy of balancing machines is much more noticeable.

In addition to the error of the balancing machines, there is also the influence of the interface between the holder and the balancing machine. The following assumptions can be made:

Repeatable residual imbalances per balancing plane

max. mass of test piece (rotor) kg	repeatable residual unbalance ^a U_{wm} gmm
< 7.0	0.75
> 7.0 to 16.0	1.5

^a Depending on the clamping accuracy in the machine. The clamping accuracy of the balancing machine is greater than that of the machine.

In addition to the repeated residual imbalances on a balancing machine (U_{wm}), further error lies in the limited repeatability of interfaces. As reference values for the common HSK interfaces, the values specified in the table can be assumed.

Joining accuracy of the HSK interface

HSK	25	32	40	50	63	80	100
^e HSK	2	2	2	2	2	3	4

In micrometers

Thus, the repeated achievable residual unbalance of the overall system can be calculated:

$$U_{min} \geq (m_{wkz} \cdot {}^e\text{HSK}) + U_{wm}$$

Example 1

Toolholder type: HSK-E 40/PG 10 x 062
 Mass of toolholder: $m_{wkz} = 0.250$ kg
 Joining accuracy HSK interface: ${}^e\text{HSK} = 2 \mu\text{m}$ for HSK 40
 Reproducible residual unbalance: $U_{wm} = 0.75$ gmm for mass < 7.0 kg

$$u_{min} \geq (0.25 \text{ kg} * 2 \mu\text{m}) + 0.75 \text{ gmm} = 1.250 \text{ gmm}$$

Example 2

Toolholder type: HSK-A 63/PG 32 x 100
 Mass of toolholder: $m_{wkz} = 1.228$ kg
 Joining accuracy HSK interface: ${}^e\text{HSK} = 2 \mu\text{m}$ for HSK 63
 Reproducible residual unbalance: $U_{wm} = 0.75$ gmm for mass < 7.0 kg

$$u_{min} \geq (1.228 \text{ kg} * 2 \mu\text{m}) + 0.75 \text{ gmm} = 3.206 \text{ gmm}$$

Compared to the permissible residual unbalance, which results at G 2.5 @ 25000 min⁻¹, the values calculated above for the reproducible residual unbalance are partially higher. As a result, not all G values are reproducible.

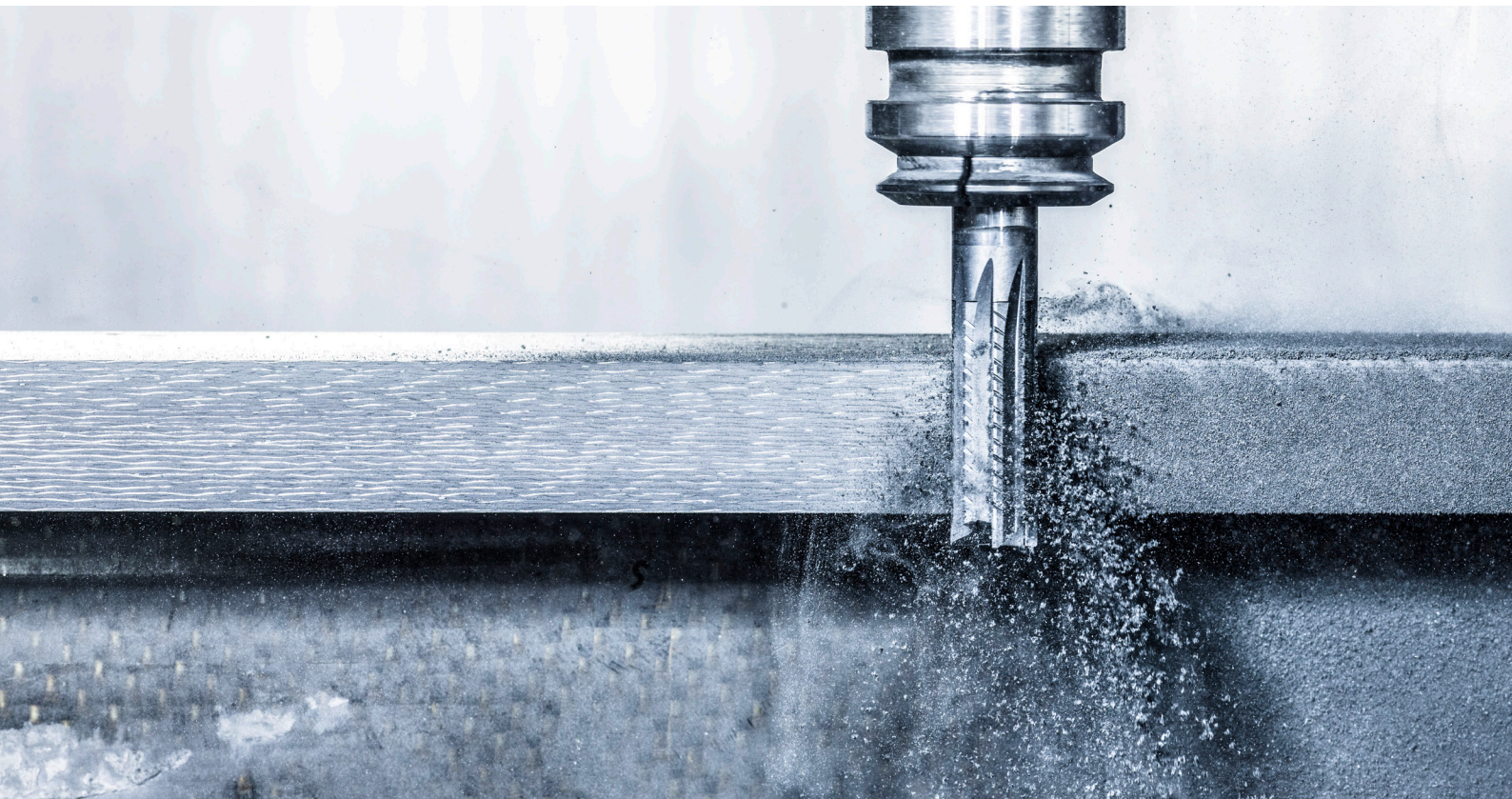

Milling strategies

Which milling strategy is the most suitable for my application? HSC, HPC or trochoidal milling? Am I focusing on a high chip removal rate or a perfectly finished surface? Choosing the most efficient method and reaching the maximum performance is the key to successful machining.

Depending on the type of machine, lot size, clamping equipment and many other factors, the fastest strategy might not be the most efficient. Sometimes, a conventional approach is faster for smaller quantities than a perfectly optimized CAM-program following the latest development.

Machines – 3, 5 or 5-axis simultaneous 3-axis and 5-axis are essentially different types of milling machines. The definition stands for the number of axes the machine can move, on a 3-axis machine it is usually X, Y and Z. If you add a rotary head and table to the machine, often called A- and C-axis, it becomes a 5-axis machine. It allows you to machine up to 5 sides of a workpiece in a single clamping as well as applications at any angle necessary. A 5-axis simultaneous machine is able to move all of its axes at the same time and is used for workpieces with complex 3D contours.

Down-milling In almost any application, down milling is the preferred method and base of modern milling strategies. Following the “thick to thin” rule, the feed is in the same direction as the rotation of the cutting tool. The maximum chip thickness is reached at the start of the cut and slowly decreases until the end of the cut. Results are better surface quality, longer tool life and less burr formation.

Up-milling If the cutting tool is fed in the opposite direction of the cutting tool rotation, an up-milling strategy is applied. The slowly increasing chip thickness causes high temperatures and a burnishing or rubbing effect due to friction, resulting in a reduced tool life. Different than in down-milling, the tool gets pulled towards the workpiece which was a welcoming effect in earlier years of milling machines. As the precision of spindles and guides couldn't reach modern standards, it helped stabilizing the milling process. In today's machining, up milling is used in workpieces with hardened, abrasive or forged surfaces, allowing the tool to start the cut in softer material to increase tool life.

Roughing The roughing process is mostly used at the beginning of a workpiece. Aiming at removing a large amount of material in the fastest and most process-safe way and get as close as possible to the final shape. Surface quality and dimensional accuracy are secondary requirements.

Finishing Following the roughing process, finishing operations are used to achieve the required specifications regarding dimensional and geometrical accuracy, surface quality, deburring and an optimal preparation for following processes such as grinding and surface treatments. Finishing tools are



designed specifically for this purpose, allowing higher cutting speeds and developed to reach a long tool life for a stable process.

HSC HSC, short for High Speed Cutting, essentially increases the metal removal rate Q by practicing exceedingly higher speeds and feeds up to 10 times and very low cutting depth and width. Compared to conventional milling methods, HSC results in an up to 30% higher material removal rate while at the same time achieving better surface quality, lower cutting forces and less heat development due to short contact times. Applications can be found in thin-walled structural parts for the aerospace industry, turbine blades, moulds or electrodes. While HSC is generating lower forces on the spindle, the tooling machine has the requirement to be able to withstand high rpm and fast movements on long term.

HPC High Performance Cutting also has its target in reaching the highest possible metal removal rate Q , although using a different strategy. While the cutting speed V_c will not reach the levels of HSC, the increased cutting depth and cutting width will make the difference. While the rotational speeds and the feeds are suitable for almost any type of machines, strong forces will appear to the spindle. As the surface quality mostly is lower than in High Speed Cutting, HPC is mainly used in the roughing process. Also, it has fewer requirements to CAM and programming-systems.

Trochoidal Milling Similar to HSC, trochoidal milling is based on high speeds and feeds, small A_e and maximal A_p . Mainly used in roughing and semi-roughing, its application is found in slots, corners and deep pockets. Due to a constant circular-like movement it creates a flowing process that positively affects the spindle and guides. The small chip thickness allows narrower flutes and a close pitch on the milling tool, resulting in a stronger core and increased stability to prevent vibrations.

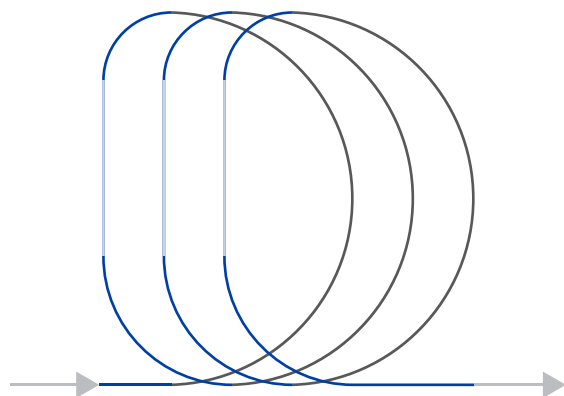
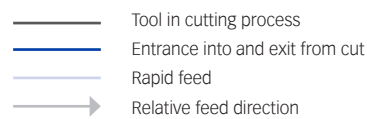

Troubleshooting when milling with end mill

Possible corrective measures when milling with end mill

Problem	Corrective measures											REGO-FIX Expert advice	
	Adjust cutting speed (Vc)	Increase feed per tooth (fz)	Reduce milling depth	Increase coolant supply	Reduce projecting length	Review tooling length	Review choice of drilling tool	Reduce work mounting	Reduce lateral infeed	Check tool wear	Review milling strategy*		Review cooling strategy
Vibrations	↓	↑			•	•	•	•	•	•		•	Strive for stable region (see stability chart) Improve result with the powRgrip® System
Low stability						•	•		•	•			Improve result with the powRgrip® System
Hevy deflection		↓				•	•			•	•		Use more stable tooling system (powRgrip®)
Poor surface quality	↑	↓			•	•	•	•	•	•	•		Improve runout and tool rigidity with the powRgrip® System
High tool wear	↓	↓			•	•	•	•	•	•			Improve runout with precision tools from REGO-FIX (ER, MR, powRgrip®)
Built-up edge	↑	↑			•						•		
Cutting edge chipping	↑	↓			•		•	•	•			•	
Tool breakage	↓	↓			•	•	•	•	•	•			•
Edge breakage on workpiece		↓					•	•		•	•		
Burrs	↓	↑										•	
Uneven surface						•	•		•	•		•	
Non-parallel surface						•	•		•	•		•	
Insufficient chip removal		↑			•				•	•		•	For peripheral cooling use CF collet (powRgrip® System) or Coolant flush disk KS (ER System)
Chip jam (only with slot milling)		↓	•	•									•

• Corrective measures

↑ Increase values ↓ Lower values

*Milling strategies:
Down-milling
Up-milling
High Performance Cutting (HPC)
High Speed Cutting (HSC)
Trochoidal Milling (TBC)

Stability chart

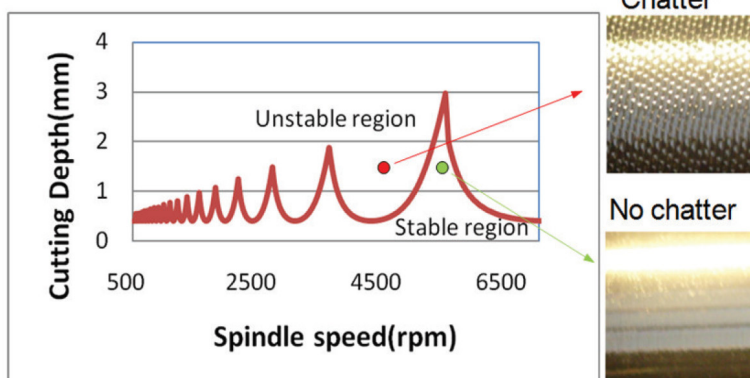

Troubleshooting when drilling

Possible corrective measures when drilling

Problem	Corrective measures										REGO-FIX Expert advice			
	Adjust cutting speed (Vc)	Increase feed per rotation (f)	Reduce coolant supply	Review projecting length	Review tooling system	Review choice of drilling tool	Review spot-drilling	Review work mounting	Check tool wear	Review work mounting		Check tool wear		
Vibrations	↓	↑			•	•					•	•	Improve result with the vibration-damping and high-precision powRgrip® System	
Deflection		↓			•	•	•	•				•		
Poor surface quality	↑	↓		•	•	•					•	•	•	Improve runout and tool rigidity with the powRgrip® System
High tool wear	↓	↓		•	•	•	•				•	•		Improve runout with precision tools from REGO-FIX (ER, MR, powRgrip®)
Tool breakage	↓	↓		•		•	•				•	•		
Bore out-of-center		↓			•	•	•	•				•	•	
Bore diameter too big	↓	↓		•	•	•					•	•	•	
Cutting edge chipping	↓	↓		•				•			•			
Built-up edge	↑	↑		•							•			
Burrs		↓											•	
Long chips	↓	↑						•						
Chip jam	↑	↓		•						•				Use tools with internal cooling, together with REGO-FIX sealing disks DS

• Corrective measures

↑ Increase values ↓ Lower values

Troubleshooting when reaming

Possible corrective measures when reaming

Problem	Corrective measures										REGO-FIX Expert advice	
	Adjust cutting speed (VC)	Adjust feed per rotation (f)	Increase pilot bore diameter	Reduce projecting length	Increase coolant supply	Review cutting data	Extend pilot bore depth	Check tool wear	Check axial offset	Check pilot bore depth		
Vibrations	↓	↑				•	•	•				
Poor surface quality				↓			•	•	•	•	•	Improve result with the self-centering REGO-FIX floating chuck
Built-up edge	↑	↑						•				
Cutting edge chipping	↓	↓	↑			•	•	•			•	
Tool breakage			↑			•	•			•	•	Improve result with the self-centering REGO-FIX floating chuck
High tool wear	↓	↓				•	•				•	
Bore not cylindrical										•	•	Improve result with the self-centering REGO-FIX floating chuck
Bore too small	↑	↓	↑					•	•		•	Eliminate radial forces with the self-centering REGO-FIX floating chuck
Bore too big	↓	↑	↓	•						•	•	Eliminate radial forces with the self-centering REGO-FIX floating chuck
Chip jam	↓	↓				•	•				•	

• Corrective measures

↑ Increase values ↓ Lower values

Troubleshooting when tapping

Possible corrective measures when tapping

Problem	Corrective measures										REGO-FIX Expert advice	
	Adjust cutting speed (VC)	Increase core hole diameter	Check tap tolerance	Review chamfering	Review tap wear	Review end of the thread	Check runout (IR)	Check synchronization	Extend clearance at end of the thread	Review feedrate or spindle synchronization		
Toolshank is spinning		↑		•								Use REGO-FIX ER-GB / PCM ET1 / PG-TAP tapping collets
Thread too big	↓		•	•	•						•	Improve dimensional accuracy with REGO-FIX tapping tools
Thread too small		↑		•	•	•						Improve dimensional accuracy with REGO-FIX tapping tools
Axial miscut thread							•				•	Use REGO-FIX tapping tools with axial compensation
Rough thread sides		↑	•	•			•				•	Use REGO-FIX tapping tools with axial compensation
High tool wear	↓		•								•	Use REGO-FIX tapping tools with axial compensation
Cutting edge chipping			•								•	Use REGO-FIX tapping tools with axial compensation
Tool breakage	↓	↑	•	•							•	Use REGO-FIX tapping tools with axial compensation

• Corrective measures

↑ Increase values ↓ Lower values

Formulas for cutting data

End mills

- d_1 Diameter of the cutting edge [mm]
- Z Number of cutting edges
- a_p Axial infeed depth [mm]
- a_e Radial infeed depth [mm]
- v_c Cutting speed [m/min]
- f_z Feed per tooth and revolution [mm]
- n Spindle speed [min^{-1}]
- v_f Feed rate [mm/min]
- f Feed per rotation [mm]
- Q Material removal rate [cm^3/min]
- d_{eff} Effective engagement diameter [mm]
- β Setting angle «Beta» [$^\circ$ – DEG]

Spindle speed	$n = \frac{v_c \times 1000}{d \times \Pi}$	$\left[\frac{1}{\text{min}} \right]$
Cutting speed	$v_c = \frac{d_1 \times n \times \Pi}{1000}$	$\left[\frac{\text{m}}{\text{min}} \right]$
Feed rate	$v_f = f_z \times Z \times n$	$\left[\frac{\text{mm}}{\text{min}} \right]$
Feed per tooth	$f_z = \frac{v_f}{Z \times n}$	$\left[\text{mm} \right]$
Feed per revolution	$f = f_z \times Z$	$\left[\text{mm} \right]$
Material removal rate	$Q = \frac{a_p \times a_e \times v_f}{1000}$	$\left[\frac{\text{cm}^3}{\text{min}} \right]$

Drills

- d_1 Diameter of the cutting edge [mm]
- v_c Cutting speed [m/min]
- f Feed per rotation [mm]
- n Spindle speed [min^{-1}]
- v_f Feed rate [mm/min]
- Q Material removal rate [cm^3/min]
- T Primary processing time for the maximum drill depth of the tool [sec]
- L Effective drill depth [mm]

Spindle speed	$n = \frac{v_c \times 1000}{d_1 \times \Pi}$	$\left[\frac{1}{\text{min}} \right]$
Cutting speed	$v_c = \frac{d_1 \times n \times \Pi}{1000}$	$\left[\frac{\text{m}}{\text{min}} \right]$
Feed rate	$v_f = f \times n$	$\left[\frac{\text{mm}}{\text{min}} \right]$
Material removal rate	$Q = \frac{d_1^2 \times \Pi \times v_f}{4 \times 1000}$	$\left[\frac{\text{cm}^3}{\text{min}} \right]$
Primary processing time	$T = \frac{L}{v_f} \times 60$	$\left[\text{sec} \right]$

Taps

- a Dimension of square end
- d Nominal diameter of the thread
- n Spindle speed
- P Thread pitch
- v_c Cutting speed
- v_f Feed rate

Spindle speed	$n = \frac{v_c \times 1000}{d \times \Pi}$	$\left[\frac{1}{\text{min}} \right]$
Cutting speed	$v_c = \frac{d \times \Pi \times n}{1000}$	$\left[\frac{\text{m}}{\text{min}} \right]$
Feed rate	$v_f = P \times n$	$\left[\frac{\text{mm}}{\text{min}} \right]$

Cutting speed conversion table for threading

Ø d ₁	Vc m/min															
	1	2	3	4	5	6	8	10	12	15	20	25	30	40	50	60
1	318	637	955	1273	1592	1910	2546	3183	3820	4775	6366	7958	9549	12732	15915	19099
2	159	318	477	637	796	955	1273	1592	1910	2387	3183	3979	4775	6366	7958	9549
3	106	212	318	424	531	637	849	1051	1273	1592	2122	2653	3183	2144	5305	6366
4	80	159	239	318	398	477	637	796	955	1194	1592	1989	2387	3163	3979	4775
5	64	127	191	255	318	382	509	637	764	955	1273	1592	1910	2546	3183	3820
6	53	106	159	212	265	318	424	531	637	796	1061	1326	1592	2122	26553	3183
8	40	80	119	159	199	239	318	398	477	597	796	995	1194	1592	1989	2387
10	32	64	95	127	159	191	255	318	382	477	637	796	955	1273	1592	1910
12	27	53	80	106	133	159	212	265	318	398	531	663	796	1061	1326	1592
14	23	45	68	91	114	136	183	227	273	341	455	568	682	909	1137	1364
16	20	40	60	80	99	119	159	199	239	298	398	497	597	796	995	1194
18	18	35	53	71	86	106	141	177	212	265	354	442	531	707	884	1061
20	16	32	48	64	80	95	127	159	191	239	318	398	477	637	796	955
25	13	25	38	51	64	76	102	127	153	191	255	318	382	509	637	764
30	11	21	32	42	53	64	85	106	127	159	212	265	318	424	531	637
35	9	18	27	36	45	55	73	91	109	136	182	227	273	364	455	546
40	8	16	24	32	40	48	64	80	95	119	159	199	239	318	398	477
45	7	14	21	28	35	42	57	71	85	106	141	177	212	283	354	424
50	6	13	19	25	32	38	51	64	76	95	127	159	191	255	318	382

Hardness comparison chart

HRC Hardness Rockwell	HB Hardness Brinell	HV Hardness Vickers	N/mm ² Mpa Tensile strenght
25	253	266	854
26	254	273	873
27	265	279	897
28	272	286	914
29	274	294	944
30	287	302	970
31	295	310	995
32	302	318	1024
33	311	327	1052
34	320	336	1082
35	329	345	1111
36	337	355	1139
37	346	364	1168
38	354	373	1198
39	363	382	1227
40	373	392	1262
41	382	402	1296
42	392	412	1327
43	402	423	1362
44	413	434	1401
45	424	446	1442
46	436	459	1481
47	448	471	1524
48	460	484	1572
49	474	499	1625
50	488	513	1668
51	502	528	1733
52	518	545	1793
53	532	560	1845
54	548	578	1912
55	566	596	1979
56	585	615	2050
57	603	634	2121
58		654	
59		675	
60		698	

Conversion chart for hardness values, according to DIN 50150

Conversion table / inch-metric

0" d ₁	Ø mm	0" d ₁	Ø mm	0" d ₁	Ø mm	0" d ₁	Ø mm	0" d ₁	Ø mm	0" d ₁	Ø mm
0	0	2-1/16	52.3876	4-1/16	103.188	6-1/16	153.988	8-1/16	204.788	10-1/16	255.588
1/16	1.5875	2-1/8	53.9751	4-1/8	104.775	6-1/8	155.575	8-1/8	206.375	10-1/8	257.176
3/32	2.3812	2-3/16	55.5626	4-3/16	106.363	6-3/16	157.163	8-3/16	207.963	10-3/16	258.763
1/8	3.1750	2-1/4	57.1501	4-1/4	107.950	6-1/4	158.750	8-1/4	209.550	10-1/4	260.351
5/32	3.9687	2-5/16	58.7376	4-5/16	109.538	6-5/16	160.338	8-5/16	211.138	10-5/16	261.938
3/16	4.7625	2-3/8	60.3251	4-3/8	111.125	6-3/8	161.925	8-3/8	212.725	10-3/8	263.526
7/32	5.5562	2-7/16	61.9126	4-7/16	112.713	6-7/16	163.513	8-7/16	214.313	10-7/16	265.113
1/4	6.3500	2-1/2	63.5001	4-1/2	114.300	6-1/2	165.100	8-1/2	215.900	10-1/2	266.701
5/16	7.9375	-	-	-	-	-	-	-	-	-	-
3/8	9.5250	-	-	-	-	-	-	-	-	-	-
7/16	11.1125	-	-	-	-	-	-	-	-	-	-
1/2	12.7000	-	-	-	-	-	-	-	-	-	-
9/16	14.2875	2-9/16	65.0876	4-9/16	115.888	6-9/16	166.688	8-9/16	217.488	10-9/16	268.288
5/8	15.8750	2-5/8	66.6751	4-5/8	117.475	6-5/8	168.275	8-5/8	219.075	10-5/8	269.876
11/16	17.4625	2-11/16	68.2626	4-11/16	119.063	6-11/16	169.863	8-11/16	220.663	10-11/16	271.463
3/4	19.0500	2-3/4	69.8501	4-3/4	120.650	6-3/4	171.450	8-3/4	222.250	10-3/4	273.051
13/16	20.6375	2-13/16	71.4376	4-13/16	122.238	6-13/16	173.038	8-13/16	223.838	10-13/16	274.638
7/8	22.2250	2-7/8	73.0251	4-7/8	123.825	6-7/8	174.625	8-7/8	225.425	10-7/8	276.226
15/16	23.8125	2-15/16	74.6126	4-15/16	125.413	6-15/16	176.213	8-15/16	227.013	10-15/16	277.813
1	25.4001	3	76.2002	5	127.00	7	177.800	9	228.600	11	279.401
1-1/16	26.9876	3-1/16	77.7877	5-1/16	128.588	7-1/16	179.388	9-1/16	230.188	11-1/16	280.988
1-1/8	28.5751	3-1/8	79.3752	5-1/8	130.175	7-1/8	180.975	9-1/8	231.775	11-1/8	282.576
1-3/16	30.1626	3-3/16	80.9627	5-3/16	131.763	7-3/16	182.563	9-3/16	233.363	11-3/16	284.163
1-1/4	31.7501	3-1/4	82.5502	5-1/4	133.350	7-1/4	184.150	9-1/4	234.950	11-1/4	285.751
1-5/16	33.3376	3-5/16	84.1377	5-5/16	134.938	7-5/16	184.738	9-5/16	236.538	11-5/16	287.338
1-3/8	34.9251	3-3/8	85.7252	5-3/8	136.525	7-3/8	187.325	9-3/8	238.125	11-3/8	288.926
1-7/16	36.5126	3-7/16	87.3127	5-7/16	138.113	7-7/16	188.913	9-7/16	239.713	11-7/16	290.513
1-1/2	38.1001	3-1/2	88.9002	5-1/2	139.700	7-1/2	190.500	9-1/2	241.300	11-1/2	292.101
1-9/16	39.6876	3-9/16	90.4877	5-9/16	141.288	7-9/16	192.088	9-9/16	242.888	11-9/16	293.688
1-5/8	41.2751	3-5/8	92.0752	5-5/8	142.875	7-5/8	193.675	9-5/8	244.475	11-5/8	295.276
1-11/16	42.8626	3-11/16	93.6627	5-11/16	144.463	7-11/16	195.263	9-11/16	246.063	11-11/16	296.863
1-3/4	44.4501	3-3/4	95.2502	5-3/4	146.051	7-3/4	196.850	9-3/4	247.650	11-3/4	298.451
1-13/16	46.0376	3-13/16	96.8377	5-13/16	147.638	7-13/16	198.438	9-13/16	249.238	11-13/16	300.038
1-7/8	47.6251	3-7/8	98.4252	5-7/8	149.225	7-7/8	200.025	9-7/8	250.825	11-7/8	301.626
1-15/16	49.2126	3-15/16	100.013	5-15/16	150.813	7-15/16	201.613	9-15/16	252.413	11-15/16	303.213
2	50.8001	4	101.600	6	152.400	8	203.200	10	254.001	12	304.801

Form and position tolerances in practice

Form tolerances according to DIN EN ISO 1101

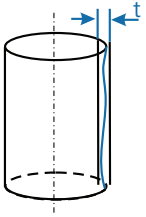

Straightness The tolerance zone is limited by two parallel lines at a distance t apart. Every envelope line of the tolerated cylinder must be between these two parallel lines.

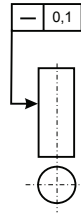

Example Every envelope line of the tolerated cylinder surface must be between two parallel lines at a distance apart of 0.1.

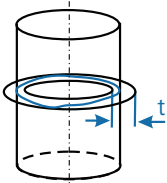

Roundness The tolerance zone is limited by two concentric circles at a distance t apart. The circumference line of the tolerated cylinder must be within a circle ring of the zone width t , in every radial section plane.

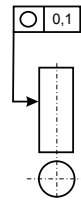

Example The circumference line of the tolerated cylinder must be within a circle ring of the zone width 0.1 in every radial section plane.

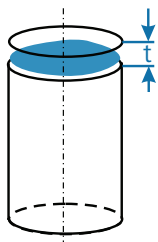

Flatness The tolerance zone is limited by two parallel planes at a distance t apart, the dimensions of which correspond to those of the tolerated area. The real workpiece area must be between the two parallel planes at distance t apart.

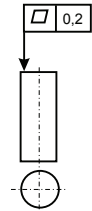

Example The real workpiece area must be between two parallel planes at a distance apart of 0.2.

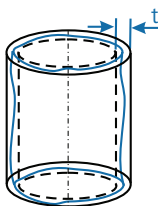

Cylindricity The tolerance zone for the cylinder envelope area limits the deviation of the roundness, the straightness of the envelope line and the parallelism of the envelope line to the cylinder axis. It is formed by two coaxial cylinders with the radial distance t .

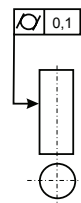

Example The tolerated cylindrical area must be between two coaxial cylinders with a radial distance of 0.1.

Position tolerances according to DIN EN ISO 1101

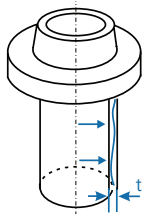

Parallelism The tolerance zone within which the envelope lines of the tolerated cylinder must lie is limited by two parallel lines at a distance t apart which run parallel to the datum plane.

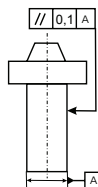

Example Every single envelope line of the tolerated area must be between two parallel lines that are at a distance of 0.1 apart, and are parallel to the center axis.

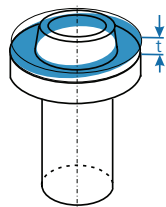

Perpendicularity The tolerance zone is limited by two parallel planes at a distance t apart, which are perpendicular to the datum axis. The tolerated plane face must be between these two planes.

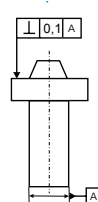

Example All points/circle lines of the tolerated area must be between two parallel planes that are at a distance of 0.1 apart, and are perpendicular to the datum plane.

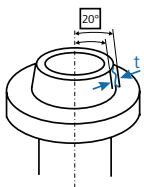

Angularity The tolerance zone is limited by two parallel planes at a distance t apart at the nominal angle to the datum axis.

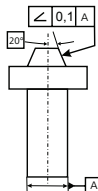

Example All points of the tolerated area must be between two parallel planes that are at a distance apart of 0.1, and are angled at 20° to the datum axis.

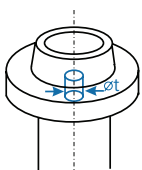

Coaxiality The tolerance zone is limited by a cylinder of diameter t , the axis of which matches the datum axis. The actual axis of the tolerated element must be within the tolerance zone.

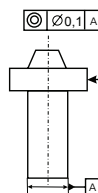

Example The axis of the tolerated cylinder must be within a cylinder that has a diameter of 0.1 and is coaxial to the datum axis A.

Run-out tolerances according to DIN EN ISO 1101

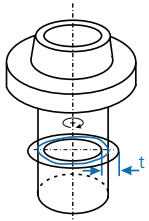

Radial run-out In every radial section plane perpendicular to the surface, the tolerance zone is limited by two concentric circles at a distance t apart, the common center point of which is on the datum axis. The radial run-out tolerance applies generally for a full revolution of the tolerated element around the datum axis.

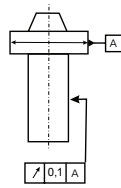

Example The circumference line of every radial section plane of the tolerated cylindrical area must be between two concentric circles at a distance apart of 0.1 with their common center point on the datum axis A.

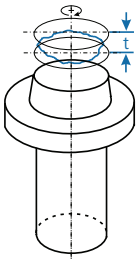

Axial run-out The tolerance zone is limited in every radial distance of two circles at a distance t apart. The circles are in a cylinder, the axis of which matches the datum axis. The diameter of the cylinder can adopt any value of the diameter of the plane face.

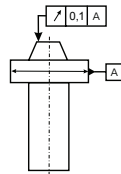

Example Every circle line of the tolerated area must be between two parallel circle planes at a distance apart of 0.1 with their common center point on the datum axis A.

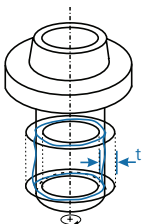

Total radial run-out The tolerance zone is limited by two coaxial cylinders at a distance t apart, the axes of which match the datum axis. After several rotations around the datum axis and axial shift of the transducer all points of the tolerated element must be within the tolerance zone.

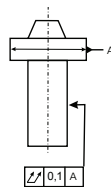

Example The tolerated cylindrical area must be between two coaxial cylinders with a radial distance apart of 0.1 with their common axis on the datum axis.

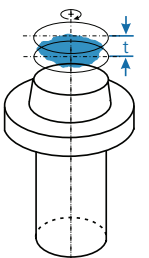

Total axial run-out The tolerance zone is limited by two parallel planes at a distance t apart, which are perpendicular to the datum (rotational) axis. After several rotations round the datum axis and radial shift of the transducer, all points of the surface of the tolerance plane face must be within the tolerance zone.

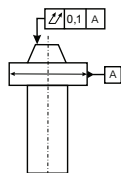

Example The tolerated area must be between two parallel circle planes at a distance apart of 0.1 with their common center point on the datum axis A.



Tolerance charts

Outside dimensions (Shafts)

Tolerances on dimensions in μm

Nominal size range in mm		g4	g5	g6	g7	h4	h5	h6	h7	h8	h9	h10	h11	h13
from	1	-2	-2	-2	-2	0	0	0	0	0	0	0	0	0
to	3	-5	-6	-8	-12	-3	-4	-6	-10	-14	-25	-40	-60	-140
over	3	-4	-4	-4	-4	0	0	0	0	0	0	0	0	0
to	6	-8	-9	-12	-16	-4	-5	-8	-12	-18	-30	-48	-75	-180
over	6	-5	-5	-5	-5	0	0	0	0	0	0	0	0	0
to	10	-9	-11	-14	-20	-4	-6	-9	-15	-22	-36	-58	-90	-220
over	10	-6	-6	-6	-6	0	0	0	0	0	0	0	0	0
to	18	-11	-14	-17	-24	-5	-8	-11	-18	-27	-43	-70	-110	-270
over	18	-7	-7	-7	-7	0	0	0	0	0	0	0	0	0
to	30	-13	-16	-20	-28	-6	-9	-13	-21	-33	-52	-84	-130	-330
over	30	-9	-9	-9	-9	0	0	0	0	0	0	0	0	0
to	50	-16	-25	-20	-34	-7	-11	-16	-25	-39	-62	-100	-160	-390

Inside dimensions (Bores)

Tolerances on dimensions in μm

Nominal size range in mm		G4	G5	G6	G7	H4	H5	H6	H7	H8	H9	H10	H11	H13
from	1	+5	+6	+8	+12	+3	+4	+6	+10	+14	+25	+40	+60	+140
to	3	+2	+2	+2	+2	0	0	0	0	0	0	0	0	0
over	3	+8	+9	+12	+16	+4	+5	+8	+12	+18	+30	+48	+75	+180
to	6	+4	+4	+4	+4	0	0	0	0	0	0	0	0	0
over	6	+9	+11	+14	+20	+4	+6	+9	+15	+22	+36	+58	+90	+220
to	10	+5	+5	+5	+5	0	0	0	0	0	0	0	0	0
over	10	+11	+14	+17	+24	+5	+8	+11	+18	+27	+43	+70	+110	+270
to	18	+6	+6	+6	+6	0	0	0	0	0	0	0	0	0
over	18	+13	+16	+20	+28	+6	+9	+13	+21	+33	+52	+84	+130	+330
to	30	+7	+7	+7	+7	0	0	0	0	0	0	0	0	0
over	30	+16	+25	+20	+34	+7	+11	+16	+25	+39	+62	+100	+160	+390
to	50	+9	+9	+9	+9	0	0	0	0	0	0	0	0	0

Thread tolerances

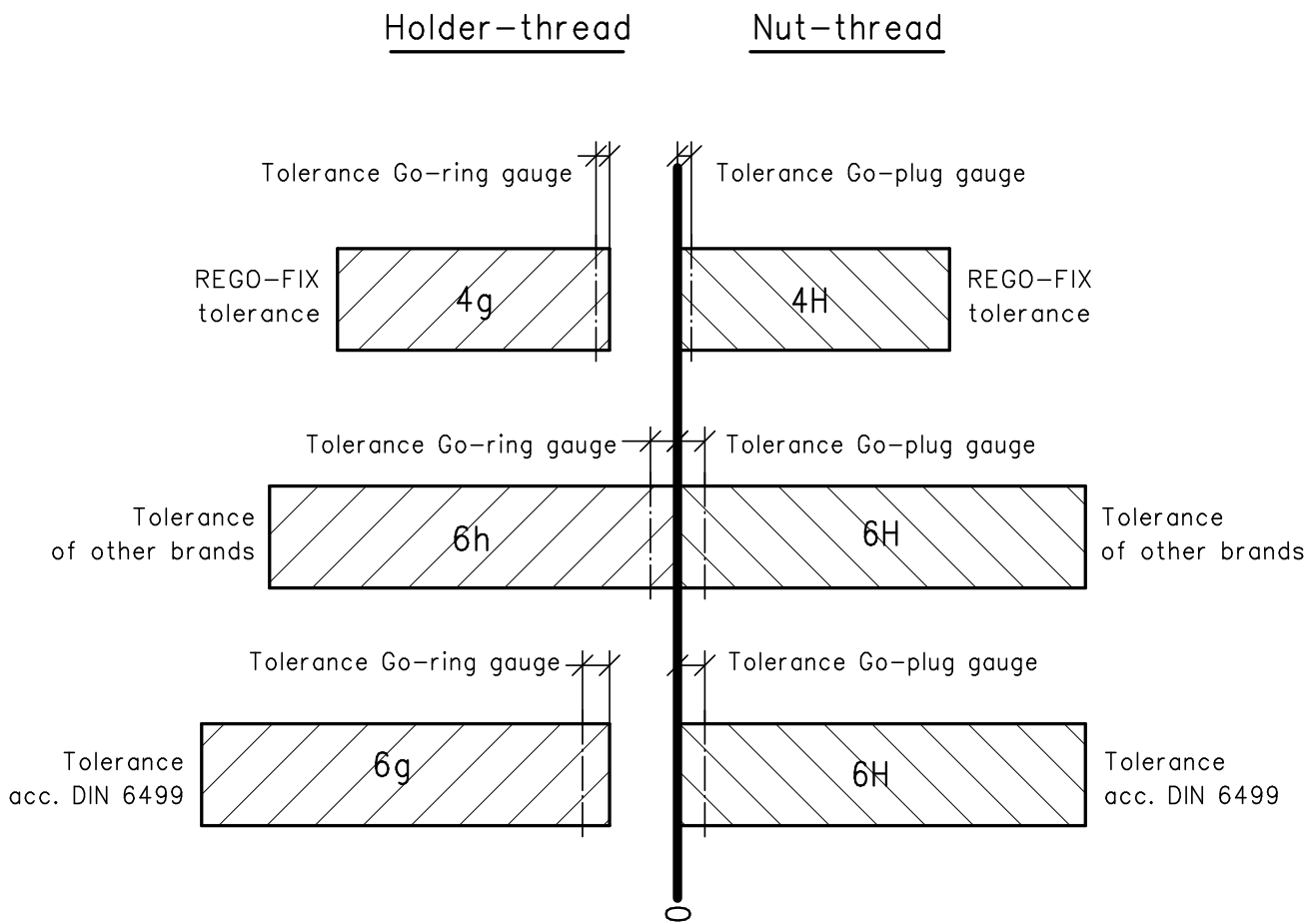

Core hole diameters for thread cutting

M DIN 13, ISO 261, *5H/6H

d1	mm	Ø mini	Ø maxi	Ø guide line
*1	0.25	0.729	0.785	0.75
*1.1	0.25	0.829	0.885	0.85
*1.2	0.25	0.929	0.985	0.95
*1.4	0.30	1.075	1.142	1.10
1.6	0.35	1.221	1.321	1.25
1.7	0.35	1.321	1.421	1.35
1.8	0.35	1.421	1.521	1.45
2	0.40	1.567	1.679	1.60
2.2	0.45	1.713	1.838	1.75
2.3	0.40	1.867	1.979	1.90
2.5	0.45	2.013	2.138	2.05
2.6	0.45	2.113	2.238	2.15
3	0.50	2.459	2.599	2.50
3.5	0.60	2.850	3.010	2.90
4	0.70	3.242	3.422	3.30
4.5	0.75	3.688	3.878	3.75
5	0.80	4.134	4.334	4.20
6	1.00	4.917	5.153	5.00
7	1.00	5.917	6.153	6.00
8	1.25	6.647	6.912	6.80
9	1.25	7.647	7.912	7.80
10	1.50	8.376	8.676	8.50
11	1.50	9.376	9.676	9.50
12	1.75	10.106	10.441	10.20
14	2.00	11.835	12.210	12.00
16	2.00	13.835	14.210	14.00
18	2.50	15.294	15.744	15.50
20	2.50	17.294	17.744	17.50
22	2.50	19.294	19.744	19.50
24	3.00	20.752	21.252	21.00
27	3.00	23.752	24.252	24.00
30	3.50	26.211	26.771	26.50
33	3.50	29.211	29.771	29.50
36	4.00	31.670	32.270	32.00
39	4.00	34.670	35.270	35.00
42	4.50	37.129	37.799	37.50
45	4.50	40.129	40.799	40.50
48	5.00	42.587	43.297	43.00
52	5.00	46.587	47.297	47.00
56	5.50	50.046	50.796	50.50

MF DIN 13, ISO 261, 6H

d1	mm	Ø mini	Ø maxi	Ø guide line
2.5	0.35	2.121	2.221	2.15
3	0.35	2.621	2.721	2.65
3.5	0.35	3.121	3.221	3.15
4	0.50	3.459	3.599	3.50

MF DIN 13, ISO 261, 6H

d1	mm	Ø mini	Ø maxi	Ø guide line
4.5	0.50	3.959	4.099	4.00
5	0.50	4.459	4.599	4.50
5.5	0.50	4.959	5.099	5.00
6	0.75	5.188	5.378	5.25
7	0.75	6.188	6.378	6.25
8	0.75	7.188	7.378	7.25
8	1.00	6.917	7.153	7.00
9	0.75	8.188	8.378	8.25
9	1.00	7.917	8.153	8.00
10	0.75	9.188	9.378	9.25
10	1.00	8.917	9.153	9.00
10	1.25	8.647	8.912	8.80
11	0.75	10.188	10.378	10.25
11	1.00	9.917	10.153	10.00
12	1.00	10.917	11.153	11.00
12	1.25	10.647	10.912	10.80
12	1.50	10.376	10.676	10.50
14	1.00	12.917	13.153	13.00
14	1.25	12.647	12.912	12.80
14	1.50	12.376	12.676	12.50
15	1.00	13.917	14.153	14.00
15	1.50	13.376	13.676	13.50
16	1.00	14.917	15.153	15.00
16	1.50	14.376	14.676	14.50
17	1.00	15.917	16.153	16.00
17	1.50	15.376	15.676	15.50
18	1.00	16.917	17.153	17.00
18	1.50	16.376	16.676	16.50
18	2.00	15.835	16.210	16.00
20	1.00	18.917	19.153	19.00
20	1.50	18.376	18.676	18.50
20	2.00	17.835	18.210	18.00
22	1.00	20.917	21.153	21.00
22	1.50	20.376	20.676	20.50
22	2.00	19.835	20.210	20.00
24	1.00	22.917	23.153	23.00
24	1.50	22.376	22.676	22.50
24	2.00	21.835	22.210	22.00
25	1.00	23.917	24.153	24.00
25	1.50	23.376	23.676	23.50
25	2.00	22.835	23.210	23.00
27	1.50	25.376	25.676	25.50
27	2.00	24.835	25.210	25.00
28	1.00	26.917	27.153	27.00
28	1.50	26.376	26.676	26.50
28	2.00	25.835	26.210	26.00
30	1.00	28.917	29.153	29.00

MF DIN 13, ISO 261, 6H

d1	mm	Ø mini	Ø maxi	Ø guide line
30	1.50	28.376	28.676	28.50
30	2.00	27.835	28.210	28.00
32	1.50	30.376	30.676	30.50
32	2.00	29.835	30.210	30.00
33	1.50	31.376	31.676	31.50
33	2.00	30.835	31.210	31.00
35	1.50	33.376	33.676	33.50
36	1.50	34.376	34.676	34.50
36	2.00	33.835	34.210	34.00
36	3.00	32.752	33.252	33.00
39	1.50	37.376	37.676	37.50
39	2.00	36.835	37.210	37.00
39	3.00	35.752	36.252	36.00
40	1.50	38.376	38.676	38.50
40	2.00	37.835	38.210	38.00
40	3.00	36.752	37.252	37.00
42	1.50	40.376	40.676	40.50
42	2.00	39.835	40.210	40.00
42	3.00	38.752	39.252	39.00
45	1.50	43.376	43.676	43.50
45	2.00	42.835	43.210	43.00
45	3.00	41.752	42.252	42.00
48	1.50	46.376	46.676	46.50
48	2.00	45.835	46.210	46.00
48	3.00	44.752	45.252	45.00
50	1.50	48.376	48.676	48.50
50	2.00	47.835	48.210	48.00
50	3.00	46.752	47.252	47.00
52	1.50	50.376	50.676	50.50
52	2.00	49.835	50.210	50.00
52	3.00	48.752	49.252	49.00
55	2.00	52.835	53.210	53.00
60	2.00	57.835	58.210	58.00

MF EN 60423:1994, 7H

d1	mm	Ø mini	Ø maxi	Ø guide line
8	1.00	6.917	7.217	7.00
10	1.00	8.917	9.217	9.00
12	1.50	10.376	10.751	10.50
16	1.50	14.376	14.751	14.50
20	1.50	18.376	18.751	18.50
25	1.50	23.376	23.751	23.50
32	1.50	30.376	30.751	30.50
40	1.50	38.376	38.751	38.50
63	1.50	61.376	61.751	61.50

UNC ANSI B1.1, 2B

d1	TPI	mm	Ø mini	Ø maxi	Ø guide line
1	64	0.397	1.425	1.582	1.45
2	56	0.454	1.695	1.871	1.75
3	48	0.529	1.941	2.146	2.00
4	40	0.635	2.157	2.385	2.25
5	40	0.635	2.487	2.697	2.55
6	32	0.794	2.642	2.895	2.75
8	32	0.794	3.302	3.530	3.40
10	24	1.058	3.683	3.962	3.80
12	24	1.058	4.344	4.597	4.40
1/4"	20	1.270	4.979	5.257	5.10
5/16"	18	1.411	6.401	6.731	6.50
3/8"	16	1.588	7.798	8.153	8.00
7/16"	14	1.814	9.144	9.550	9.30
1/2"	13	1.954	10.592	11.023	10.80
9/16"	12	2.117	11.989	12.446	12.20
5/8"	11	2.309	13.386	13.868	13.60
3/4"	10	2.540	16.307	16.840	16.60
7/8"	9	2.822	19.177	19.761	19.50
1"	8	3.175	21.971	22.606	22.30
1 1/8"	7	3.629	24.638	25.349	25.00
1 1/4"	7	3.629	27.813	28.524	28.20
1 3/8"	6	4.233	30.353	31.115	30.80
1 1/2"	6	4.233	33.528	34.290	34.00
1 3/4"	5	5.080	38.964	39.827	39.50
2"	4.5	5.644	44.679	45.593	45.30

UNJC ISO 3161:1999, 3B

d1	TPI	mm	Ø mini	Ø maxi	Ø guide line
4	40	0.635	2.228	2.393	2.30
5	40	0.635	2.558	2.723	2.60
6	32	0.794	2.733	2.939	2.80
8	32	0.794	3.393	3.599	3.45
10	24	1.058	3.795	4.064	3.90
12	24	1.058	4.455	4.704	4.55
1/4"	20	1.270	5.113	5.387	5.20
5/16"	18	1.411	6.563	6.833	6.70
3/8"	16	1.588	7.978	8.255	8.10
7/16"	14	1.814	9.347	9.639	9.40
1/2"	13	1.954	10.798	11.095	10.90
9/16"	12	2.117	12.228	12.482	12.40
5/8"	11	2.309	13.627	13.904	13.80
3/4"	10	2.540	16.576	16.881	16.70

Core hole diameters for thread cutting

UNF ANSI B1.1, 2B

d1	TPI	mm	Ø mini	Ø maxi	Ø guide line
0	80	0.318	1.182	1.305	1.20
1	72	0.353	1.474	1.612	1.50
2	64	0.397	1.756	1.912	1.80
3	56	0.454	2.025	2.197	2.10
4	48	0.529	2.271	2.458	2.35
5	44	0.577	2.551	2.740	2.60
6	40	0.635	2.820	3.022	2.90
8	36	0.706	3.404	3.606	3.50
10	32	0.794	3.963	4.165	4.05
12	28	0.907	4.496	4.724	4.60
1/4"	28	0.907	5.360	5.588	5.50
5/16"	24	1.058	6.782	7.035	6.90
3/8"	24	1.058	8.382	8.636	8.50
7/16"	20	1.270	9.729	10.033	9.80
1/2"	20	1.270	11.329	11.607	11.40
9/16"	18	1.411	12.751	13.081	12.90
5/8"	18	1.411	14.351	14.681	14.50
3/4"	16	1.588	17.323	17.678	17.50
7/8"	14	1.814	20.270	20.675	20.40
1"	12	2.117	23.114	23.571	23.30
1 1/8"	12	2.117	26.289	26.746	26.50
1 1/4"	12	2.117	29.464	29.921	29.70
1 3/8"	12	2.117	32.639	33.096	32.80
1 1/2"	12	2.117	35.814	36.271	36.00

UNJF ISO 3161:1999, 3B

d1	TPI	mm	Ø mini	Ø maxi	Ø guide line
0	80	0.318	1.217	1.298	1.25
1	72	0.353	1.511	1.603	1.55
2	64	0.397	1.798	1.902	1.85
3	56	0.454	2.073	2.189	2.15
4	48	0.529	2.329	2.466	2.35
5	44	0.577	2.614	2.764	2.70
6	40	0.635	2.888	3.053	2.95
8	36	0.706	3.480	3.663	3.60
10	32	0.794	4.054	4.255	4.10
12	28	0.907	4.602	4.816	4.70
1/4"	28	0.907	5.466	5.662	5.55
5/16"	24	1.058	6.906	7.109	7.00
3/8"	24	1.058	8.494	8.679	8.60
7/16"	20	1.270	9.876	10.084	10.00
1/2"	20	1.270	11.463	11.661	11.55
9/16"	18	1.411	12.913	13.122	13.05
5/8"	18	1.411	14.501	14.702	14.60
3/4"	16	1.588	17.506	17.722	17.60
7/8"	14	1.814	20.460	20.706	20.50
1"	12	2.117	23.340	23.594	23.40

UNEF ANSI B1.1, 2B

d1	TPI	mm	Ø mini	Ø maxi	Ø guide line
12	32	0.794	4.623	4.826	4.70
1/4"	32	0.794	5.487	5.689	5.60
5/16"	32	0.794	7.087	7.264	7.20
3/8"	32	0.794	8.662	8.864	8.75
7/16"	28	0.907	10.135	10.337	10.25
1/2"	28	0.907	11.710	11.938	11.85
9/16"	24	1.058	13.132	13.385	13.20
5/8"	24	1.058	14.732	14.986	14.80
11/16"	24	1.058	16.307	16.560	16.40
3/4"	20	1.270	17.679	17.957	17.80
13/16"	20	1.270	19.254	19.558	19.40
7/8"	20	1.270	20.854	21.132	21.00
1"	20	1.270	24.029	24.307	24.10

UN ANSI B1.1, 2B

d1	TPI	mm	Ø mini	Ø maxi	Ø guide line
5/16"	20	1.270	6.554	6.858	6.70
3/8"	20	1.270	8.154	8.432	8.30
9/16"	20	1.270	12.904	13.208	13.00
5/8"	20	1.270	14.504	14.782	14.60
1 1/8"	8	3.175	25.146	25.781	25.50
1 1/4"	8	3.175	28.321	28.956	28.70
1 3/8"	8	3.175	31.496	32.131	31.80
1 1/2"	8	3.175	34.671	35.306	35.00
1 5/8"	8	3.175	37.846	38.481	38.20
1 3/4"	8	3.175	41.021	41.656	41.40
1 7/8"	8	3.175	44.196	44.831	44.50
2"	8	3.175	47.371	48.006	47.70
2 1/4"	8	3.175	53.721	54.356	54.10
2 1/2"	8	3.175	60.071	60.706	60.40

UNS ANSI B1.1, 2B

d1	TPI	mm	Ø mini	Ø maxi	Ø guide line
10	36	0.706	4.064	4.216	4.10
10	40	0.635	4.141	4.292	4.20
10	56	0.454	4.344	4.445	4.40
1/4"	36	0.706	5.588	5.740	5.65
1/4"	40	0.635	5.665	5.816	5.70
1/4"	48	0.529	5.766	5.892	5.80
1/4"	56	0.454	5.868	5.969	5.90
5/16"	36	0.706	7.163	7.340	7.25
3/8"	36	0.706	8.763	8.940	8.80
7/16"	24	1.058	9.957	10.210	10.00
1/2"	24	1.058	11.557	11.811	11.60
1"	14	1.814	23.445	23.825	23.60

G (BSP) DIN ISO 228

d1	TPI	mm	Ø mini	Ø maxi	Ø guide line
1/16"	28	0.907	6.561	6.843	6.75
1/8"	28	0.907	8.566	8.848	8.75
1/4"	19	1.337	11.445	11.890	11.60
3/8"	19	1.337	14.950	15.395	15.20
1/2"	14	1.814	18.631	19.172	18.90
5/8"	14	1.814	20.587	21.128	20.90
3/4"	14	1.814	24.117	24.658	24.40
7/8"	14	1.814	27.877	28.418	28.20
1"	11	2.309	30.291	30.931	30.70
1 1/8"	11	2.309	34.939	35.579	35.30
1 1/4"	11	2.309	38.952	39.592	39.30
1 3/8"	11	2.309	41.365	42.005	41.80
1 1/2"	11	2.309	44.845	45.485	45.20
1 3/4"	11	2.309	50.788	51.428	51.20
2"	11	2.309	56.656	57.296	57.00
2 1/4"	11	2.309	62.752	63.392	63.10
2 1/2"	11	2.309	72.226	72.866	72.60
3"	11	2.309	84.926	85.566	85.30

W (BSW) BS 84, (DIN11-1970)

d1	TPI	mm	Ø mini	Ø maxi	guide line
3/32"	48				1.80
1/8"	40	0.635	2.362	2.591	2.50
5/32"	32				3.10
3/16"	24	1.058	3.406	3.744	3.60
7/32"	24				4.40
1/4"	20	1.270	4.724	5.156	4.90
5/16"	18	1.411	6.129	6.588	6.40
3/8"	16	1.588	7.493	7.988	7.70
7/16"	14	1.814	8.791	9.332	9.10
1/2"	12	2.117	9.987	10.589	10.30
5/8"	11	2.309	12.918	13.558	13.30
3/4"	10	2.540	15.799	16.484	16.20
7/8"	9	2.822	18.613	19.355	19.25
1"	8	3.175	21.336	22.149	21.90

PG DIN 40430

d1	TPI	mm	Ø mini	Ø maxi	Ø guide line
7	20	1.270	11.28	11.43	11.35
9	18	1.411	13.86	14.01	13.90
11	18	1.411	17.26	17.41	17.30
13.5	18	1.411	19.06	19.21	19.10
16	18	1.411	21.16	21.31	21.20
21	16	1.588	26.78	27.03	26.80
29	16	1.588	35.48	35.73	35.50
36	16	1.588	45.48	45.73	45.50
42	16	1.588	52.48	52.73	52.50
48	16	1.588	57.78	58.03	57.80

TR ISO 2901-2904, DIN 103, 7H

d1	mm	Ø mini	Ø maxi	Ø guide line
10	2	8	8.236	8.20
12	3	9	9.315	9.25
14	3	11	11.315	11.25
16	4	12	12.375	12.25
18	4	14	14.375	14.25
20	4	16	16.375	16.25
22	5	17	17.450	17.25
24	5	19	19.450	19.25
26	5	21	21.450	21.25
28	5	23	23.450	23.25
30	6	24	24.500	24.25
32	6	26	26.500	26.25

Shank diameter of taps

	Thread	ISO 529*		ISO 2283		DIN 371		DIN 357/376		DIN 352		JIS B 4430 1998		ASME B 94.9 1999	
	[mm]	[Zoll]	[Ø]	[□]	[Ø]	[□]	[Ø]	[□]	[Ø]	[□]	[Ø]	[□]	[Ø]	[□]	[Ø]
M 1	–	2.5	2	–	–	2.5	2.1	–	–	2.5	2.1	3	2.5	–	–
M 1.1	–	2.5	2	–	–	2.5	2.1	–	–	2.5	2.1	3	2.5	–	–
M 1.2	–	2.5	2	–	–	2.5	2.1	–	–	2.5	2.1	3	2.5	–	–
M 1.4	–	2.5	2	–	–	2.5	2.1	–	–	2.5	2.1	3	2.5	–	–
M 1.6	1/16	2.5	2	–	–	2.5	2.1	–	–	2.5	2.1	3	2.5	0.141	0.11
M 1.7	–	–	2	–	–	2.5	2.1	–	–	2.5	2.1	3	2.5	–	–
M 1.8	–	2.5	2	–	–	2.5	2.1	–	–	2.5	2.1	3	2.5	0.141	0.11
M 2	–	2.5	2	–	–	2.8	2.1	–	–	2.8	2.1	3	2.5	0.141	0.11
M 2.2	–	2.8	2.24	–	–	2.8	2.1	–	–	2.8	2.1	3	2.5	0.141	0.11
M 2.3	–	–	–	–	–	2.8	2.1	–	–	2.8	2.1	3	2.5	–	–
M 2.5	3/32	2.8	2.25	–	–	2.8	2.1	–	–	2.8	2.1	3	2.5	0.141	0.11
M 2.6	–	–	–	–	–	2.8	2.1	–	–	2.8	2.1	3	2.5	–	–
M 3	1/8	3.15	2.5	2.24	1.8	3.5	2.7	2.2	–	3.5	2.1	4	3.2	0.141	0.11
M 3.5	–	3.55	2.8	2.5	2	4	3	2.5	2.1	4	3	4	3.2	0.141	0.11
M 4	5/32	4	3.15	3.15	2.5	4.5	3.4	2.8	2.1	4.5	3.4	5	4	0.168	0.131
M 4.5	3/16	4.5	3.55	3.55	2.8	6	4.9	3.5	2.7	6	4.9	5	4	0.194	0.152
M 5	–	5	4	4	3.15	6	4.9	3.5	2.7	6	4.9	5.5	4.5	0.194	0.152
M 6	1/4	6.3	5	4.5	3.55	6	4.9	4.5	3.4	6	4.9	6	4.5	0.255	0.191
M 7	5/16	7.1	5.6	5.6	4.5	7	5.5	5.5	4.3	6	4.9	6.2	5	0.318	0.238
M 8	–	8	6.3	6.3	5	8	6.2	6	4.9	6	4.9	6.2	5	0.318	0.238
M 9	–	9	7.1	7.1	5.6	9	7	7	5.5	7	5.5	7	5.5	–	–
M 10	3/8	10	8	8	6.3	10	8	7	5.5	7	5.5	7	5.5	0.318	0.286
M 11	–	8	6.3	8	6.3	–	–	8	6.2	8	6.2	8	6	–	–
M 12	1/2	9	7.1	9	7.1	–	–	9	7	9	7	8.5	6.5	0.367	0.275
M 14	9/16	11.2	9	11.2	9	–	–	11	9	11	9	10.5	8	0.429	0.322
M 16	5/8	12.5	10	12.5	10	–	–	12	9	12	9	12.5	10	0.48	0.36
M 18	11/16	14	11.2	14	11.2	–	–	14	11	14	11	14	11	0.542	0.406
M 20	13/16	14	11.2	14	11.2	–	–	16	12	16	12	15	12	0.652	0.489
M 22	7/8	16	12.5	16	12.5	–	–	18	14.5	18	14.5	17	13	0.697	0.523
M 24	15/16	18	14	18	14	–	–	18	14.5	18	14.5	19	15	0.76	0.571
M 27	1/16	20	16	–	–	–	–	20	16	20	16	20	15	0.896	0.672
M 30	3/16	20	16	–	–	–	–	22	18	22	18	23	17	1.021	0.766

All dimensions in mm (except US standard ASME B 94.9 in inch)

*M3–M10 with reinforced shank

Material comparison chart

Material No.	DIN	AFNOR	BS	GOST	USA
1.2002	125Cr1	C120E3UCr4	–	–	–
1.2008	140 Cr 3	130 C 3	–	–	–
1.2067	102Cr6	100Cr6	BL 3	X (LUX15)	L 3 (AISI)
1.2080	X210Cr12	X200Cr12	BD 3	X12	D 3 (AISI)
1.2083	X40Cr14	X40Cr144	–	40X13	–
1.2201	G-X 165 Cr V 12	–	–	–	–
1.2208	31 Cr V 3	–	–	3X ϕ	–
1.2210	115CrV3	–	–	X ϕ	L 2 (AISI)
1.2235	80CrV2	–	–	8X ϕ	–
1.2241	51CrMnV4	–	–	5X ϕ	–
1.2249	45SiCrV6	45SiCrV6	–	–	–
1.2303	100CrMo5	–	–	–	L 7 (AISI)
1.2316	X36CrMo17	–	–	40X16M	–
1.2323	48CrMoV6-7	45 CDV 6	–	5XM ϕ	–
1.2330	35CrMo4	–	BP 20	–	P 20 (AISI)
1.2341	6CrMo15-5	–	–	–	P 4 (AISI)
1.2343	X37CrMoV5-1	X38CrMoV5	BH 11	4Ch5MFS	H 11 (AISI)
1.2344	X40CrMoV5-1	X40CrMoV5	BH 13	4Ch5MF1S	H 13 (AISI)
1.2357	50CrMoV13-14	50 CDV 13	–	–	–
1.2363	X100CrMoV5	X100CrMoV5	BA 2	X5GM	A 2 (AISI)
1.2365	32CrMoV12-28	32 CDV 12-28	BH 10	3Ch3M3F	H 10 (AISI)
1.2367	X38CrMoV5-3	X38CrMoV5-3	–	4X5M3 ϕ	–
1.2369	81MoCrV42-16	–	–	–	613 (AISI)
1.2379	X153CrMoV12	X160CrMoV12	BD 2	X12M ϕ	D 2 (AISI)
1.2419	105WCr6	105 WC 13	–	XBF	–
1.2436	X210CrW12	X210CrW12-1	–	X12B	–
1.2510	100MnCrW4	90 MWCV 5	BO 1	XFB ϕ	O 1 (AISI)
1.2542	45WCrV7	45 WCV 20	BS 1	5XB2C ϕ	S 1 (AISI)
1.2550	60WCrV7	–	–	6XB2C ϕ	–
1.2567	30WCrV17-2	X32WCrV5	–	3X2B4 ϕ	–
1.2581	X30WCrV9-3	X30WCrV9	BH 21	3X2B8 ϕ	H 21 (AISI)
1.2606	X37CrMoW5-1	X35CrWMoV5	BH 12	H 12 (AISI)	–
1.2662	X30WCrCoV9-3	–	–	4Ch3M2WFGS	–
1.2706	X 3 NiCoMo 18 8 5	–	–	03N18K8M5T-WD	–
1.2709	X3NiCoMoTi18-9-5	–	–	03N18K9M5T-WD	–

Material No.	DIN	AFNOR	BS	GOST	USA
1.2713	55NiCrMoV6	55 NCDV 7	BH 224/5	5XH2M ϕ -Y	L 6 (AISI)
1.2714	55NiCrMoV7	–	–	5XH2M ϕ	L 6 (AISI)
1.2735	15NiCr14	–	–	–	P 6 (AISI)
1.2742	55CrNiMoV4-2-4	55 CNDV 4	–	–	–
1.2764	X19NiCrMo4	–	–	20XH4M	–
1.2766	35NiCrMo16	–	BP 30	35XH4M	–
1.2767	45NiCrMo16	–	–	45X2H4M	–
1.2769	G45CrNiMo4-2	–	–	–	–
1.2779	X6NiCrTi26-15	–	–	–	660 (AISI)
1.2782	X16CrNiSi25-20	X15CrNiSi25-20	–	–	–
1.2786	X13NiCrSi36-16	X15NiCrSi37-18	–	–	–
1.2787	X23CrNi17	X21CrNi17	–	–	–
1.2833	100V1	100V2	BW 2	–	W 210 (AISI)
1.2842	90MnCrV8	90 MV 8	BO 2	9Г2 ϕ	O 2 (AISI)
1.2880	G-X 165 Cr Co Mo 12	–	–	–	–
1.3202	HS12-1-4-5	–	BT 15	P12M ϕ 4K5	T 15 (AISI)
1.3207	HS10-4-3-10	10-4-3-10	BT 42	P10M4 ϕ 3K10	–
1.3243	HS6-5-2-5	6-5-2-5	BM 35	R6M5K5	–
1.3245	HS6-5-2-5S	–	–	–	–
1.3246	HS7-4-2-5	7-4-2-5	–	–	41 (AISI)
1.3247	HS2-9-1-8	2-9-1-8	BM 42	P2M10K8 ϕ	M 42 (AISI)
1.3249	HS2-9-2-8	–	BM 34	–	M 33 (AISI)
1.3255	HS18-1-2-5	18-1-1-5	BT 4	P18M ϕ 2K5	T 4 (AISI)
1.3257	HS18-1-2-15	–	–	–	–
1.3265	HS18-1-2-10	–	BT 5	–	T 5 (AISI)
1.3302	HS12-1-4	–	–	P12M ϕ 4	–
1.3318	HS12-1-2	–	–	P12M ϕ 2	–
1.3333	HS3-3-2	–	–	P12M ϕ 2	–
1.3339	HS6-5-2	–	–	–	–
1.3340	HS6-5-2CS	–	–	–	–
1.3341	HS6-5-2S	–	–	–	–
1.3342	HS6-5-2C	6-5-2 HC	–	P6M5 ϕ 3	3 Class 1
1.3343	HS6-5-2	6-5-2	BM 2	R6M5	611 (AISI)
1.3344	HS6-5-3	6-5-3	–	P6M5 ϕ 3	M 3 Class 1
1.3345	HS6-5-3C	–	–	–	–
1.3346	HS2-9-1	2-8-1	BM 1	P2M9 ϕ	H 41 (AISI)
1.3348	HS2-9-2	2-9-2	–	P2M9 ϕ 2	M 7 (AISI)
1.3355	HS18-0-1	18-0-1	BT 1	R18	T 1 (AISI)

Material No.	DIN	AFNOR	BS	GOST	USA
1.3401	X120Mn12	–	BW 10	110G13L	–
1.3402	X110Mn14	–	–	Np-G13A	–
1.3501	100Cr2	100Cr2	–	WX4	E 50100 (SAE)
1.3503	105 Cr 4	–	–	–	E 51100 (AISI)
1.3505	100Cr6	100 C 6	2 S.135	WX15	E 52100 (SAE)
1.3520	100CrMn6	100 CM 6	–	WX15CF	–
1.4000	X6Cr13	X6Cr13	403 S 17	08X13	403 (AISI)
1.4001	G-X 7 Cr 13	–	–	–	410 S (AISI)
1.4002	X6CrAl13	X6CrAl13	405 S 17	–	405 (AISI)
1.4003	X 2 Cr 11	X2CrNi12	X2CrNi12	–	–
1.4005	X12CrS13	X12CrS13	416 S 21	12X13-Y	416 (AISI)
1.4006	X12Cr13	X12Cr13	1630 grade A	12X13	410 (AISI)
1.4007	X35Cr14	–	–	Np-40Ch13	–
1.4008	GX7CrNiMo12-1	GX7CrNiMo12-1	GX7CrNiMo12-1	–	–
1.4010	X2Cr17	X2Cr17	–	–	–
1.4011	GX12Cr12	GX12Cr12	GX12Cr12	–	–
1.4016	X6Cr17	X6Cr17	430 S 15	08X17	430 (AISI)
1.4017	X6CrNi17-1	X6CrNi17-1	X6CrNi17-1	–	–
1.4021	X20Cr13	X20Cr13	420 S 37	20X13	420 (AISI)
1.4024	X15Cr13	Z 12 C 13 M	420 S 29	20X13	420 (SAE)
1.4027	GX20Cr14	X30Cr13	1630 grade B	28ГМ	–
1.4028	X30Cr13	X29CrS13	420 S 45	30X13	–
1.4029	X29CrS13	X39Cr13	X29CrS13	–	–
1.4031	X39Cr13	X46Cr13	X39Cr13	40X13	–
1.4034	X46Cr13	X45CrS13	X46Cr13	46X13	–
1.4035	X45CrS13	–	–	–	–
1.4037	X65Cr13	X17CrNi16-2	–	65Ch13	–
1.4057	X17CrNi16-2	Z 20 CN 17.2 M	431 S 29	17X16H2	431 (AISI)
1.4059	GX22CrNi17	–	ANC 2	–	–
1.4086	GX120Cr29	X6CrNiMo12	1648 grade B 1	–	–
1.4102	X6CrNiMo12	X14CrMoS17	–	–	–
1.4104	X14CrMoS17	X14CrMoS17	X14CrMoS17	–	430 F (AISI)
1.4105	X6CrMoS17	X6CrMoS17	X6CrMoS17	–	–
1.4106	X2CrMoSiS18-2-1	X2CrMoSiS18-2-1	–	–	–
1.4107	GX8CrNi12	–	GX8CrNi12	–	–
1.4109	X70CrMo15	X70CrMo15	X70CrMo15	–	–
1.4110	X55CrMo14	Z 50 CD 15 Cl	–	–	–
1.4112	X90CrMoV18	X 89 CrMoV 18-1	X90CrMoV18	90X18Mφ	440 B (AISI)

Material No.	DIN	AFNOR	BS	GOST	USA
1.4114	X6CrMoS19-2	X6CrMoS19-2	–	–	–
1.4116	X50CrMoV15	X50CrMoV15	X50CrMoV15	–	–
1.4118	X40CrMo15	X40CrMo15	–	20XFM	–
1.4120	GX20CrMo13	–	–	–	–
1.4121	X22CrMoNiS13-1	X22CrMoNiS13-1	–	–	–
1.4122	GX35CrMo17	X38CrMo16-1	X39CrMo17-1	39X17M	–
1.4125	X105CrMo17	X105CrMo17	X105CrMo17	110Ch18M-SChD	440 C (AISI)
1.4136	GX70CrMo29-2	Z 60 CD 29.2 M	–	–	–
1.4300	X 12 CrNi 18 8	–	302 S 25	–	–
1.4301	X5CrNi18-10	X5CrNi18-10	302 S 17	08Ch18N10	304 (AISI)
1.4302	X5CrNi19-9	–	308 S 96	Sw-04Ch19N9	–
1.4303	X4CrNi18-12	X4CrNi18-12	305 S 17	06Ch18N11	305 (L) (AISI)
1.4305	X8CrNiS18-9	X8CrNiS18-9	303 S 22	10X18H9-Y	303 (AISI)
1.4306	X2CrNi19-11	X2CrNi19-11	1631 grade C	03Ch18N11	304 L (AISI)
1.4307	X2CrNi18-9	X2CrNi18-9	X2CrNi18-9	03X18H9	–
1.4308	GX5CrNi19-10	GX5CrNi19-10	1631 grade A	07Ch18N9L	304 H (SAE)
1.4309	GX2CrNi19-11	GX2CrNi19-11	1631 grade C	–	–
1.4310	X 12 CrNi 17 7	X10CrNi18-8	301 S 21	–	301 (AISI)
1.4311	X2CrNiN18-10	X2CrNiN18-10	304 S 61	–	304 LN (AISI)
1.4312	GX10CrNi18-8	Z 10 CN 18.9 M	1631 grade D	10Ch18N9L	–
1.4313	X3CrNiMo13-4	X3CrNiMo13-4	425 C 11	03X13H4M	S 41500 (AISI)
1.4316	X1CrNi19-9	Z 1 CN 20-10	308 S 92	Sw-01Ch19N9	–
1.4317	GXZ5CrNi13-4	X4CrNi13-4	425 C 11	–	–
1.4318	X2CrNiN18-7	X2CrNiN18-7	X2CrNiN18-7	–	–
1.4319	X3CrNiN17-8	X3CrNiN17-8	301 S 26	–	–
1.4324	–	–	302 S 26	–	302 (SAE)
1.4332	X2CrNi24-12	Z 2 CNS 25-13	309 S 92	–	–
1.4333	X 5 NiCr 32 21	–	–	–	330 (AISI)
1.4335	X1CrNi25-21	X1CrNi25-21	X1CrNi25-21	–	–
1.4337	X10CrNi30-9	Z 10 CN 30-09	312 S 94	–	–
1.4347	GX6CrNiN26-7	GX6CrNiN26-7	GX6CrNiN26-7	–	–
1.4361	X1CrNiSi18-15-4	X1CrNiSi18-15-4	X1CrNiSi18-15-4	–	–
1.4362	X2CrNiN23-4	X2CrNiN23-4	X2CrNiN23-4	–	–
1.4370	X15CrNiMn18-8	Z 8 CNM 19-09-07	307 S 98	–	–
1.4371	X2CrMnNiN17-7-5	X2CrMnNiN17-7-5	202 S 16	–	202 (AISI)
1.4372	X12CrMnNiN17-7-5	X12CrMnNiN17-7-5	X12CrMnNiN17-7-5	–	–
1.4373	X12CrMnNiN18-9-5	X12CrMnNiN18-9-5	284 S 16	–	–
1.4375	X2CrMnNiN20-9-7	X2CrMnNiN20-9-7	–	–	S 21904 (AISI)

Material No.	DIN	AFNOR	BS	GOST	USA
1.4401	X5CrNiMo17-12-2	X5CrNiMo17-12-2	316 S 17	08X17H13M2	316 (AISI)
1.4403	X5CrNiMo19-11	–	316 S 96	–	–
1.4404	X2CrNiMo17-12-2	X2CrNiMo17-12-2	1632 grade F	03X17H13M2	–
1.4405	GX4CrNiMo16-5-1	GX4CrNiMo16-5-1	1632 grade F	–	–
1.4406	X2CrNiMoN17-11-2	X2CrNiMoN17-11-2	316 S 61	–	316 LN (AISI)
1.4408	GX5CrNiMo19-11-2	GX5CrNiMo19-11-2	1632 grade B	07Ch18N10G2S2M2L	–
1.4409	GX2CrNiMo19-11-2	GX2CrNiMo19-11-2	GX2CrNiMo19-11-2	–	–
1.4410	X2CrNiMoN25-7-4	X2CrNiMoN25-7-4	X2CrNiMoN25-7-4	–	S 32750 (AISI)
1.4411	GX4CrNiMo16-5-2	GX4CrNiMo16-5-2	GX4CrNiMo16-5-2	–	–
1.4412	GX5CrNiMo19-11-3	GX5CrNiMo19-11-3	GX5CrNiMo19-11-3	–	–
1.4413	X 3 CrNiMo 13 4	X3CrNiMo13-4	–	–	S 41500 (AISI)
1.4416	GX2NiCr- MoN25-20-5	GX2NiCr- MoN25-20-5	GX2NiCr- MoN25-20-5	–	–
1.4417	GX2CrNiMoN25-7-3	GX2CrNiMoN25-7-3	GX2CrNiMoN25-7-3	–	S 31500 (AISI)
1.4418	X4CrNiMo16-5-1	X4CrNiMo16-5-1	X4CrNiMo16-5-1	–	–
1.4420	X 5 CrNiMo 18 11	–	315 S 16	–	–
1.4429	X2CrNiMoN17-13-3	X2CrNiMoN17-13-3	316 S 63	–	316 LN (AISI)
1.4430	X2CrNiMo19-12	Z 2 CND 19-12-03	316 S 92	–	–
1.4431	X12CrNiMo19-10	Z 8 CND 18.10.3 M	–	–	–
1.4432	X2CrNiMo17-12-3	X2CrNiMo17-12-3	316 S 12	06Ch17N13M3-WD	–
1.4434	X2CrNiMoN18-12-4	X2CrNiMoN18-12-4	X2CrNiMoN18-12-4	–	–
1.4435	X2CrNiMo18-14-3	X2CrNiMo18-14-3	1632 grade F	03Ch17N14M3	316 L (AISI)
1.4436	X3CrNiMo17-13-3	X3CrNiMo17-13-3	316 S 19	05X17H13M3	316 (AISI)
1.4437	GX6CrNiMo18-12	Z 4 CND 19.13 M	–	08X17H13M2	316 (SAE)
1.4438	X2CrNiMo18-15-4	X2CrNiMo18-15-4	317 S 12	–	317 L (AISI)
1.4439	GX3CrNi- MoN17-13-5	X2CrNiMo17-13-5	X2CrNiMo17-13-5	–	–
1.4441	X2CrNiMo18-15-3	X2CrNiMo18-15-3	–	–	–
1.4442	X2CrNiMoN18-15-4	Z 3 CND 19-14 Az	–	–	–
1.4446	GX2CrNi- MoN17-13-4	GX2CrNi- MoN17-13-4	GX2CrNi- MoN17-13-4	–	–
1.4448	GX6CrNiMo17-13	–	1632 grade A	–	–
1.4449	X3CrNiMo18-12-3	–	317 S 16	–	317 (AISI)
1.4454	–	–	–	–	S 21900 (AISI)
1.4458	GX2NiCrMo28-20-2	GX2NiCrMo28-20-2	GX2NiCrMo28-20-2	–	–
1.4459	X8CrNiMo23-13	Z 3 CND 22-15-03	–	–	–
1.4460	X3CrNiMoN27-5-2	X3CrNiMoN27-5-2	X3CrNiMoN27-5-2	10Ch26N5M	329 (AISI)
1.4462	X2CrNiMoN22-5-3	X2CrNiMoN22-5-3	318 S 13	03X22H5AM3	S 31803 (AISI)
1.4465	X1CrNiMoN25-25-2	–	–	02Ch25N22AM2-PT	310 MoLN (AISI)
1.4466	X1CrNiMoN25-22-2	X1CrNiMoN25-22-2	X1CrNiMoN25-22-2	–	–
1.4468	GX2CrNiMoN25-6-3	GX2CrNiMoN25-6-3	GX2CrNiMoN25-6-3	03Ch24N6AM3	–

Material No.	DIN	AFNOR	BS	GOST	USA
1.4469	GX2CrNiMoN26-7-4	GX2CrNiMoN26-7-4	GX2CrNiMoN26-7-4	–	S 32615 (AISI)
1.4470	GX2CrNiMoN22-5-3	GX2CrNiMoN22-5-3	GX2CrNiMoN22-5-3	–	–
1.4500	GX7NiCrMoCuNb25-20	Z 3 NCDU 25.20 M	332 C 11	–	–
1.4501	X2CrNiMoCuWN25-7-4	X2CrNiMoCuWN25-7-4	X2CrNiMoCuWN25-7-4	–	–
1.4502	X8CrTi18	X8CrTi18	–	–	–
1.4504	–	–	–	–	631 (AISI)
1.4507	X2CrNiMoCuN25-6-3	X2CrNiMoCuN25-6-3	X2CrNiMoCuN25-6-3	–	–
1.4508	GX2CrNiMoCuWN25-8-4	Z 4 CNUD 17-11-03 FF	–	–	–
1.4509	X2CrTiNb18	X2CrTiNb18	X2CrTiNb18	–	–
1.4510	X3CrTi17	X3CrTi17	X3CrTi17	05X17T	430 Ti (AISI)
1.4511	X3CrNb17	X3CrNb17	X3CrNb17	–	–
1.4512	X2CrTi12	X2CrTi12	409 S 19	–	409 (AISI)
1.4513	X2CrMoTi17-1	X2CrMoTi17-1	X2CrMoTi17-1	–	–
1.4516	X6CrNiTi12	X6CrNiTi12	X6CrNiTi12	–	–
1.4517	GX2CrNiMoCuN25-6-3-3	GX2CrNiMoCuN25-6-3-3	GX2CrNiMoCuN25-6-3-3	–	–
1.4519	X2CrNiMoCu20-25	–	904 S 92	–	–
1.4520	X2CrTi17	X2CrTi17	X2CrTi17	–	–
1.4521	X2CrMoTi18-2	X2CrMoTi18-2	X2CrMoTi18-2	20XH2M	443 (AISI)
1.4522	X2CrMoNb18-2	–	–	–	443 (AISI)
1.4523	X2CrMoTiS18-2	X2CrMoTiS18-2	X2CrMoTiS18-2	–	–
1.4525	GX5CrNiCu16-4	GX5CrNiCu16-4	GX5CrNiCu16-4	–	–
1.4526	X6CrMoNb17-1	X6CrMoNb17-1	X6CrMoNb17-1	–	–
1.4527	GX4NiCrCuMo30-20-4	GX4NiCrCuMo30-20-4	GX4NiCrCuMo30-20-4	–	–
1.4529	X1NiCrMoCuN25-20-7	X1CrNiMoCuN25-20-7	X1NiCrMoCuN25-20-7	–	N 08926 (AISI)
1.4532	X8CrNiMoAl15-7-2	X8CrNiMoAl15-7-2	X8CrNiMoAl15-7-2	–	631 (AISI)
1.4533	X6CrNiTi18-10S	–	–	05Ch18N10T	–
1.4534	X3CrNiMoAl13-8-2	–	–	–	–
1.4537	X1CrNiMoCuN25-25-5	X1CrNiMoCuN25-25-5	X1CrNiMoCuN25-25-5	–	–
1.4539	X1NiCrMoCu25-20-5	X1NiCrMoCu25-20-5	904 S 13	–	904 L (AISI)
1.4540	GX4CrNiCuNb16-4	Z 4 CNUNb 16.4 M	–	–	–
1.4541	X6CrNiTi18-10	X6CrNiTi18-10	321 S 12	08X18H10T	321 (AISI)
1.4542	X5CrNiCuNb16-4	X5CrNiCuNb16-4	X5CrNiCuNb16-4	–	630 (AISI)
1.4543	X3CrNiCuTi12-9	–	2 T.66	–	–
1.4544	–	–	2 S.129	08X18H10T	321 (SAE)
1.4545	–	–	–	–	S 15500 (AISI)
1.4546	X5CrNiNb18-10	–	2 S.130	–	347 (SAE)
1.4547	X1CrNiMoCuN20-18-7	X1CrNiMoCuN20-18-7	X1CrNiMoCuN20-18-7	–	S 31254 (AISI)
1.4548	X5CrNiCuNb17-4-4	–	–	–	630 (AISI)

Material No.	DIN	AFNOR	BS	GOST	USA
1.4550	X6CrNiNb18-10	X6CrNiNb18-10	347 S 20	08Ch18N12B	347 (AISI)
1.4551	X5CrNiNb19-9	Z 6 CNNb 20-10	–	–	–
1.4552	GX5CrNiNb19-11	GX5CrNiNb19-11	1631 grade B	–	–
1.4555	X2CrNiNb21-10	–	347 S 96	–	–
1.4557	GX2CrNiMoCuN20-18-6	GX2CrNiMoCuN20-18-6	GX2CrNiMoCuN20-18-6	–	–
1.4559	G-X 7 NiCrMoCuNb 4220	–	–	–	–
1.4560	X3CrNiCu19-9-2	X3CrNiCu19-9-2	X3CrNiCu19-9-2	–	–
1.4563	X1NiCrMoCu31-27-4	X1NiCrMoCu31-27-4	X1NiCrMoCu31-27-4	–	–
1.4564	–	–	–	–	631 (AISI)
1.4565	X2CrNiMnMoNbN25-18-5-4	–	–	–	S 34565 (AISI)
1.4567	X 3 CrNiCu 18 9	X3CrNiCu18-9-4	394 S 17	–	–
1.4568	X7CrNiAl17-7	X7CrNiAl17-7	301 S 81	09Ch17N7Ju1	631 (AISI)
1.4570	X6CrNiCuS18-9-2	X6CrNiCuS18-9-2	X6CrNiCuS18-9-2	–	–
1.4571	X6CrNiMoTi17-12-2	X6CrNiMoTi17-12-2	320 S 18	08Ch16N11M3T	316 Ti (AISI)
1.4573	GX3CrNiMoCuN24-6-5	–	320 S 33	08Ch17N13M2T	316 Ti (AISI)
1.4574	–	Z 9 CNDA 15-07	–	–	631 (AISI)
1.4575	X1CrNiMoNb28-4-2	–	–	–	S 32803 (AISI)
1.4576	X5CrNiMoNb19-12	Z 4 CNDSNb 19-12-03	18 S 96	–	–
1.4578	X3CrNiCuMo17-11-3-2	X3CrNiCuMo17-11-3-2	X3CrNiCuMo17-11-3-2	–	–
1.4580	G-X 10 CrNiMoNb 18 10	X6CrNiMoNb17-12-2	318 S 17	08X17H13M2T	316 Cb (AISI)
1.4581	X5CrNiMoNb19-11-2	GX5CrNiMoNb19-11-2	1632 grade C	–	–
1.4583	GX10CrNiMoNb18-12	–	–	–	–
1.4584	GX2NiCrMoCu25-20-5	GX2NiCrMoCu25-20-5	GX2NiCrMoCu25-20-5	–	–
1.4587	GX2NiCrMoCuN29-25-5	GX2NiCrMoCuN29-25-5	GX2NiCrMoCuN29-25-5	–	–
1.4588	GX2NiCrMoCuN25-20-6	GX2NiCrMoCuN25-20-6	GX2NiCrMoCuN25-20-6	–	–
1.4590	X2CrNbZr17	X2CrNbZr17	X2CrNbZr17	–	–
1.4592	X2CrMoTi29-4	X2CrMoTi29-4	X2CrMoTi29-4	–	–
1.4594	X5CrNiMoCuNb14-5	X5CrNiMoCuNb14-5	X5CrNiMoCuNb14-5	–	–
1.4601	X6CrNb12	–	–	–	–
1.4602	X4CrCu17-1	–	–	–	–
1.4603	X1CrTi17	–	–	–	–
1.4604	X2CrTi20	–	–	–	–
1.4605	X2CrAlTi18-2	–	X2CrAlTi18-2	–	–
1.4650	X2CrNiCu19-10	–	–	–	–
1.4651	6CrNiCuS18-9-4	–	–	–	HNV 2 (SAE)
1.4704	45SiCr16-11	–	–	–	–
1.4710	GX30CrSi6	–	–	–	–
1.4713	X10CrAl7	–	X10CrAlSi7	12X7C10	–

Material No.	DIN	AFNOR	BS	GOST	USA
1.4718	G-X 45 CrSi 9 3	X45CrSi9-3	401 S 45	45X9C3	HNV 3 (SAE)
1.4720	X7CrTi12	-	-	-	409 (AISI)
1.4724	X10CrAl13	Z 13 C 13	X10CrAlSi13	10Ch13SJü	-
1.4725	CrAl 14 4	-	-	-	-
1.4731	X40CrSiMo10-2	X40CrSiMo10-2	X40CrSiMo10-2	40Ch10S2M	-
1.4736	X3CrAlTi18-2	-	X3CrAlTi18-2	-	-
1.4742	X10CrAl18	Z 12 CAS 18	X10CrAlSi18	15Ch18SJü	-
1.4745	GX40CrSi23	-	-	-	-
1.4747	X 80 CrNiSi 20	-	-	-	HNV 6 (SAE)
1.4748	X85CrMoV18-2	X85CrMoV18-2	X85CrMoV18-2	-	-
1.4749	X18CrN28	-	X18CrN28	-	-
1.4762	X10CrAl24	Z 12 CAS 25	X10CrAlSi25	-	446 (AISI)
1.4763	X8Cr24	X8Cr24	-	-	-
1.4765	CrAl 25 5	-	-	Ch23Ju5T	-
1.4767	CrAl 20 5	-	-	-	-
1.4768	CrAl 21 6	-	-	-	-
1.4776	GX40CrSi28	-	-	-	-
1.4818	X6CrNiSiNcE19-10	-	X6CrNiSiNcE19-10	-	S 30415 (AISI)
1.4820	G-X 12 CrNi 26 5	-	-	-	-
1.4821	X15CrNiSi25-4	-	X15CrNiSi25-4	-	-
1.4825	GX25CrNiSi18-9	-	-	-	302 mod. (SAE)
1.4826	GX40CrNiSi22-10	-	-	-	-
1.4828	X15CrNiSi20-12	Z 17 CNS 20-12	309 S 24	20Ch20N14S2	309 (AISI)
1.4829	X12CrNi22-12	-	309 S 94	-	-
1.4832	GX25CrNiSi20-14	-	-	20Ch20N14S2L	-
1.4833	X 7 CrNi 23 14	Z 15 CN 23-13	309 S 24	-	309 S (AISI)
1.4835	X9CrNiSiNcE21-11-2	-	X9CrNiSiNcE21-11-2	-	S 30815 (AISI)
1.4837	GX40CrNiSi25-12	-	1648 grade E	40Ch24N12SL	-
1.4840	GX15CrNi25-20	-	-	15Ch23N18L	-
1.4841	X15CrNiSi25-20	Z 15 CNS 25-20	314 S 25	20Ch25N20S2	310 (AISI)
1.4842	X12CrNi25-20	Z 12 CN 26-21	310 S 94	-	-
1.4843	CrNi 25 20	-	-	ChN20JuS	-
1.4845	X12CrNi25-21	Z 12 CN 26-21	310 S 16	08X25H10	310 S (AISI)
1.4846	X40CrNi25-21	-	310 S 98	-	-
1.4847	X8CrNiAlTi20-20	-	-	-	334 (AISI)
1.4848	GX40CrNiSi25-20	-	1648 grade F	-	-
1.4849	GX40NiCrSiNb38-18	-	-	-	-
1.4852	G40NiCrSiNb35-26	-	-	-	-

Material No.	DIN	AFNOR	BS	GOST	USA
1.4854	X6NiCrSiNc35-25	-	X6NiCrSiNc35-25	-	-
1.4855	GX30CrNiSiNb24-24	-	-	-	-
1.4857	GX40NiCrSi35-25	-	-	-	-
1.4859	GX10NiCrNb32-20	-	-	-	-
1.4860	NiCr 30 20	-	-	-	-
1.4864	X12NiCrSi35-16	Z 20 NCS 33-16	NA 17	-	330 (AISI)
1.4865	GX40NiCrSi38-18	-	330 C 11	-	-
1.4866	X33CrNiMnN23-8	X33CrNiMnN23-8	X33CrNiMnN23-8	-	EV 16 (SAE)
1.4870	X53CrMnNiNbN21-9	X53CrMnNiNbN21-9	352 S 52	-	-
1.4871	X53CrMnNiN21-9	X53CrMnNiN21-9	349 S 52	55Ch20G9AN4	EV 8 (SAE)
1.4872	X25CrMnNiN25-9-7	-	X25CrMnNiN25-9-7	-	-
1.4873	X45CrNiW18-9	-	-	-	-
1.4875	X55CrMnNiN20-8	X55CrMnNiN20-8	X55CrMnNiN20-8	-	EV 12 (SAE)
1.4876	X10NiCrAlTi32-20	Z 10 NC 32-21	NA 15	-	N 08800 (AISI)
1.4877	X6NiCrNbCe32-27	-	X6NiCrNbCe32-27	-	-
1.4878	X12CrNiTi18-9	Z 6 CNT 18-10	321 S 31	-	-
1.4882	X50CrMnNiNbN21-9	-	X50CrMnNiNbN21-9	-	XEV-F (SAE)
1.4886	X10NiCrSi35-19	-	X10NiCrSi35-19	-	-
1.4887	X10NiCrSiNb35-22	-	X10NiCrSiNb35-22	-	-
1.4891	X 4 CrNiSiN 18 10	-	-	-	S 30415 (AISI)
1.4893	X 8 CrNiSiN 21 11	-	-	-	S 30815 (AISI)
1.4903	X10CrMoVnb9-1	X10CrMoV9-1	-	-	-
1.4909	X2CrNiMoN17-12-2	-	S.161	-	-
1.4910	X3CrNi-MoBN17-13-3	-	X3CrNi-MoBN17-13-3	-	-
1.4911	X8CrCoNiMo10-6	Z 9 CKD 11	S.152	-	-
1.4912	X7CrNiNb18-10	X7CrNiNb18-10	-	-	-
1.4913	X19CrMoNbVN11-1	Z 21 CDNbv 11	X19CrMoNbVN11-1	-	-
1.4919	X6CrNiMo17-13	X6CrNiMoB17-12-2	316 S 50	10X18H13M2	316 H (AISI)
1.4922	X20CrMoV11-1	X20CrMoV11-1	762	-	-
1.4923	X22CrMoV12-1	X19CrMoNbVN11-1	X22CrMoV12-1	-	-
1.4928	G-X 12CrNiMoCoVN 12	-	-	-	-
1.4931	GX23CrMoV12-1	GX23CrMoV12-1	-	-	-
1.4935	X20CrMoWV12-1	-	-	-	422 (AISI)
1.4938	X11CrNiMoN12	X12CrNiMoV12-3	X12CrNiMoV12-3	-	-
1.4939	X12CrNiMo12	Z 12 CNDV 12-03	S.151	-	S 64152 (AISI)
1.4941	X6CrNiTiB18-10	X6CrNiTiB18-10	321 S 51	-	-
1.4943	X4NiCrTi25-15	Z 5 NCTDV 25-15 B	HR 251	-	660 (AISI)
1.4944	-	-	HR 51	-	660 (AISI)

Material No.	DIN	AFNOR	BS	GOST	USA
1.4948	X6CrNi18-10	X6CrNi18-10	304 S 50	10X20H10	304 H (AISI)
1.4949	X3CrNiN18-11	-	304 S 51	-	-
1.4958	X5NiCrAlTi31-20	Z 8 NC 33-21	NA 15	-	N 08810 (AISI)
1.4959	X8NiCrAlTi32-21	Z 8 NC 33-21	NA 15	-	-
1.4961	X8CrNiNb16-13	-	347 S 51	-	-
1.4971	X12CrCoNi21-20	-	-	-	661 (AISI)
1.4980	X5NiCrTi26-15	-	-	-	-
1.4982	X10CrNi-MoMnNbVB15-10-1	X10CrNi-MoMnNbVB15-10-1	X10CrNi-MoMnNbVB15-10-1	-	-
1.4986	X7CrNiMoBNb16-16	X7CrNiMoBNb16-16	X7CrNiMoBNb16-16	-	-
1.4988	G-X 8 CrNiMoVNb 16 13	-	-	-	-
1.5023	38Si7	40Si7	-	-	-
1.5024	46Si7	46 S 7	-	-	-
1.5025	51Si7	50 S 7	-	-	-
1.5026	55Si7	55 S 7	251 A 58	55S2	9255 (SAE)
1.5027	60Si7	60 S 7	251 A 60	60S2	9260 (SAE)
1.5029	71Si7	-	-	70S2ChA	-
1.5069	36Mn7	-	-	-	1340 H (SAE)
1.5121	46MnSi4	-	-	-	-
1.5122	37MnSi5	38 MS 5	-	-	-
1.5128	10 MnSi 4 4	-	-	-	-
1.5403	17MnMoV6-4	-	271	-	-
1.5406	17MoV8-4	-	-	-	-
1.5415	15 Mo 3	15 D 3	16Mo3	15M	-
1.5419	G20Mo5	-	243-430	-	4422 (SAE)
1.5422	G18Mo5	-	G18Mo5	-	-
1.5423	16Mo5	-	-	-	4419 (SAE)
1.5430	G8MnMo7-4	-	-	-	-
1.5506	17MnB3	-	9/0	-	-
1.5509	23B2	25 B 3	-	-	-
1.5510	28B2	25 B 3	-	-	-
1.5511	35B2	35 B 3	35B2	-	-
1.5523	19MnB4	19MnB4	19MnB4	-	15B21 H (SAE)
1.5527	40MnB4	-	10/1	-	-
1.5530	20MnB5	20 MB 5	20MnB5	-	-
1.5531	30MnB5	30 MB 5	30MnB5	-	-
1.5532	38MnB5	38 MB 5	38MnB5	40GR	-
1.5621	G10Ni6	-	-	-	-
1.5622	14Ni6	16 N 6	-	-	-

Material No.	DIN	AFNOR	BS	GOST	USA
1.5633	24Ni8	20 N 8	–	–	–
1.5636	G9Ni10	–	G9Ni10	–	–
1.5637	10 Ni 14	12 N 14	12Ni14	–	–
1.5638	G9Ni14	–	503 LT 60	–	–
1.5639	16 Ni 14	–	–	–	2317 (SAE)
1.5662	G-X 8 Ni 9	9 Ni	502-650	–	–
1.5663	X7Ni9	X7Ni9	510	–	–
1.5680	12Ni19	12Ni19	12Ni19	–	2515 (SAE)
1.5681	GS-10 Ni 19	–	–	–	2512 (SAE)
1.5710	36 NiCr 6	30 NC 6	–	–	3135 (SAE)
1.5711	40NiCr6	–	–	40ChN	3140 (SAE)
1.5713	13NiCr6	–	–	–	3115 (SAE)
1.5714	16NiCr4	16NiCr4	16NiCr4	16XГH	–
1.5715	16NiCrS4	16NiCrS4	16XГH-Y	–	–
1.5732	14NiCr10	16 NC 11	–	–	3415 (SAE)
1.5736	36NiCr10	30 NC 11	–	–	3435 (SAE)
1.5737	30NiCr11	30 NC 12	–	–	–
1.5752	14NiCr14	10 NC 12	15NiCr13	17XH3	3310 (SAE)
1.5755	31 NiCr 14	18 NC 13	–	–	–
1.5805	10NiCr5-4	10NiCr5-4	10NiCr5-4	10XГH1	–
1.6523	20NiCrMo2-2	20 NCD 2	20NiCrMo2-2	20XГHM	8615 (SAE)
1.6526	20NiCrMoS2-2	20NiCrMoS2-2	20NiCrMoS2-2	20XГHM-Y	–
1.6528	GS-60 NiCrMo 2	–	–	–	8660 (SAE)
1.6541	23MnNiCrMo5-2	23 MNCD 5	–	–	–
1.6543	21 NiCrMo 2 2	–	805 A 20	–	8622 (SAE)
1.6545	30NiCrMo2-2	30 NCD 2	–	–	8630 (SAE)
1.6546	40NiCrMo2-2	40 NCD 2	7	38ChGNM	8640 (SAE)
1.6552	G24CrNiMo3-2-5	–	–	–	–
1.6562	40 NiCrMo 8 4	–	817 M 40	–	4337 (SAE)
1.6563	41NiCrMo7-3-2	41NiCrMo7-3-2	41NiCrMo7-3-2	–	–
1.6565	40NiCrMo6	–	818 M 40	40XГH2M	4340 (SAE)
1.6566	17NiCrMo6-4	17NiCrMo6-4	17NiCrMo6-4	17XГH1M	–
1.6569	17NiCrMoS6-4	17NiCrMoS6-4	17NiCrMoS6-4	17XГH1M-Y	–
1.6570	G30NiCrMo8-5	–	–	–	–
1.6571	20NiCrMoS6-4	20NiCrMoS6-4	20NiCrMoS6-4	20XГH2M-Y	–
1.6580	30CrNiMo8	30 CND 8	30CrNiMo8	30X2H2M	–
1.6582	34CrNiMo6	34CrNiMo6	34CrNiMo6	34X2H2M	–
1.6587	17CrNiMo6	18 CND 6	18CrNiMo7-6	18X2ГH2M	–

Material No.	DIN	AFNOR	BS	GOST	USA
1.6655	32NiCrMo12-5	30 NCD 12	–	–	–
1.6657	14NiCrMo13-4	14NiCrMo13-4	14NiCrMo13-4	14XH3M	9310 (SAE)
1.7015	15Cr3	12 C 3	523 M 15	–	5015 (SAE)
1.7016	17Cr3	17Cr3	17Cr3	17XГ	5117 (SAE)
1.7023	38CrS2	38 C 2 u	38 C 2 u	38X-Y	–
1.7025	46CrS2	46CrS2	46CrS2	46X-Y	–
1.7030	28Cr4	28Cr4	28Cr4	28XГ	5130 (SAE)
1.7033	34Cr4	32 C 4	32 C 4	35X	5132 (SAE)
1.7034	37Cr4	37Cr4	37Cr4	37X	5135 (SAE)
1.7035	41Cr4	41Cr4	41Cr4	40X	5140 (SAE)
1.7036	28CrS4	28CrS4	28CrS4	28XГ-Y	–
1.7037	34CrS4	32 C 4 u	34CrS4	34X-Y	–
1.7038	37CrS4	37CrS4	37CrS4	37X-Y	–
1.7039	41CrS4	41CrS4	41CrS4	40X-Y	–
1.7102	54SiCr6	54SiCr6	–	–	9254 (SAE)
1.7106	55SiCr7	–	251 A 60	–	–
1.7108	60SiCr7	56SiCr7	–	–	9261 (SAE)
1.7117	52SiCrNi5	52SiCrNi5	–	–	–
1.7131	16MnCr5	16 MC 5	16MnCr5	16XГ	5115 (SAE)
1.7137	60MnCrB3	–	–	–	–
1.7138	52MnCrB3	–	–	–	–
1.7139	16MnCrS5	16MnCrS5	16MnCrS5	16XГ-Y	–
1.7147	20MnCr5	20 MC 5	20MnCr5	20XГ	5120 (SAE)
1.7149	20MnCrS5	20MnCrS5	20MnCrS5	20XГ-Y	–
1.7150	G20MnCr5	–	–	16XГP	–
1.7160	16MnCrB5	16MnCrB5	16MnCrB5	–	–
1.7176	55Cr3	55 C 3	525 A 58	50ChGA	5155 (SAE)
1.7182	27MnCrB5-2	27MnCrB5-2	27MnCrB5-2	–	–
1.7185	33MnCrB5-2	33MnCrB5-2	33MnCrB5-2	–	–
1.7189	39MnCrB6-2	39MnCrB6-2	39MnCrB6-2	–	–
1.7190	58 CrMnB 4	–	–	–	51B60 (SAE)
1.7213	25CrMoS4	25 CD 4 u	25CrMoS4	25XM-Y	–
1.7214	–	–	2 S.142	–	–
1.7218	25CrMo4	25 CD 4	25CrMo4	25XM	4130 (SAE)
1.7220	34CrMo4	34 CD 4	34CrMo4	34XM	4130 (SAE)
1.7221	G26CrMo4	–	–	–	–
1.7222	42CrMoPb4	–	–	35ChML	–
1.7223	41CrMo4	–	5/1	40ChFA	4142 (SAE)

Material No.	DIN	AFNOR	BS	GOST	USA
1.7225	42CrMo4	40 CD 4	42CrMo4	42XM	4140 (SAE)
1.7226	34CrMoS4	34 CD 3 u	34CrMoS4	34XM-Y 35XM	-
1.7227	42CrMoS4	42 CD 4 u	42CrMoS4	42XM-Y	-
1.7228	50CrMo4	50CrMo4	50CrMo4	50XM	4147 (SAE)
1.7233	42CrMo5-6	42CrMo5-6	42CrMo5-6	-	-
1.7242	16CrMo4	15 CD 3.5	-	-	-
1.7243	18CrMo4	18 CD 4	18CrMo4	18XM	-
1.7244	18CrMoS4	18CrMoS4	18CrMoS4	18XM-Y	-
1.7262	15CrMo5	12 CD 4 FF	-	-	-
1.7276	10CrMo11	CD 10	-	-	-
1.7281	16CrMo9-3	20 CD 8	-	-	-
1.7311	20 CrMo 2	-	-	-	-
1.7315	37 CrMo 3	-	-	-	-
1.7319	20MoCrS3	20MoCrS3	20MoCrS3	20XM-Y	-
1.7320	20MoCr3	20MoCr3	20MoCr3	20XM	-
1.7321	20MoCr4	20MoCr4	20MoCr4	20XFM	4118 (SAE)
1.7323	20MoCrS4	20MoCrS4	20MoCrS4	20XFM-Y	-
1.7333	22CrMoS3-5	22CrMoS3-5	22CrMoS3-5	22XFM-Y	-
1.7335	13 CrMo 4 4	13CrMo4-5	13CrMo4-5	13X;	-
1.7341	G34CrMo4-4	-	-	-	-
1.7353	1.7353	-	B 5	-	-
1.7354	G22CrMo5-4	-	-	-	-
1.7355	G17CrMnMo5-5	-	-	-	-
1.7357	G17CrMo5-5	-	621	-	-
1.7361	32CrMo12	-	722 M 24	-	-
1.7362	12 CrMo 19 5	X16CrMo5-1	625	12X5M	501 (AISI)
1.7363	GS-12 CrMo 19 5	-	-	-	-
1.7365	GX15CrMo5	-	625	-	-
1.7375	12CrMo9-10	12CrMo9-10	-	-	-
1.7377	G15CrMo9-10	-	-	-	-
1.7379	G17CrMo9-10	-	622	-	-
1.7380	10CrMo9-10	10CrMo9-10	10CrMo9-10	10X2M	-
1.7381	12CrMo12-10	12 CD 12.10	-	-	-
1.7383	11CrMo9-10	10 CD 9-10	11CrMo9-10	-	-
1.7386	X12CrMo9-1	-	629-470	-	504 (AISI)
1.7389	G-X 12 CrMo 10 1	-	B 6	-	-
1.7390	X15CrMo5-1	X15CrMo5-1	X15CrMo5-1	-	-
1.7503	67 CrV 2 2	-	-	70ChGFA	-

Material No.	DIN	AFNOR	BS	GOST	USA
1.7511	22CrV3	–	–	–	6118 (SAE)
1.7701	51CrMoV4	51 CDV 4	–	–	–
1.7706	G17CrMoV5-10	–	G17CrMoV5-10	–	–
1.7707	30CrMoV9	–	–	30Ch3MF	–
1.7709	21CrMoV5-7	21CrMoV5-7	21CrMoV5-7	–	–
1.7711	40CrMoV4-6	40CrMoV4-6	40CrMoV4-6	–	–
1.7715	14MoV6-3	14Mo6	660	–	–
1.8159	50 CrV 4	50 CV 4	51CrV4	50XГφ	6150 (SAE)
1.8507	34CrAlMo5	CAD 6.12	–	–	–
1.8509	41CrAlMo7	–	905 M 39	38Ch2MJuA	E 71400 (SAE)
2.4631	NiCr20TiAl	–	2 HR 201	–	HEV 5 (SAE)
2.4632	NiCr20Co18Ti	–	2 HR 2	–	HEV 6 (SAE)
2.4636	NiCo15Cr15MoAlTi	–	HR 4	–	–
2.4639	SG-NiCr20	–	NA 34	–	–
2.4650	NiCo20Cr20MoTi	–	2 HR 1	–	–
2.4652	EL-NiCr26Mo	–	–	–	S 32654 (AISI)
2.4654	NiCr19Co14Mo4Ti	–	–	–	XEV-H (SAE)
2.4660	NiCr20CuMo	–	–	–	N 08020 (AISI)
2.4665	NiCr22Fe18Mo	–	HR 204	–	–
2.4667	SG-NiCr19NbMoTi	–	NA 51	–	–
2.4668	NiCr19Fe19Nb5Mo3	–	–	–	XEV-I (SAE)
2.4669	NiCr15Fe7Ti2Al	NiCr15Fe7TiAl	NiCr15Fe7TiAl	–	688 (AISI)
2.4806	SG-NiCr20Nb	–	NA 35	–	–
2.4810	NiMo 30	Ni-Mo 28	ANC 15	–	–
2.4816	NiCr15Fe	–	HR 208	–	–
2.4819	NiMo16Cr15W	Ni-Mo 16 Cr 15	–	–	–
2.4831	SG-NiCr21Mo9Nb	–	–	–	–
2.4851	NiCr23Fe	–	NiCr23Fe	–	–
2.4854	NiFe33Cr25Co	–	–	–	S 35315 (AISI)
2.4856	NiCr22Mo9Nb	–	NA 21	–	–
2.4858	NiCr21Mo	–	NA 16	–	–
2.4867	NiCr60-15	–	–	Ch15N60	–
2.4869	NiCr 80 20	–	–	Ch20N80	–
2.4886	SG-NiMo16Cr16W	–	NA 48	–	–
1.4889	NiCr28FeSiCe	–	NiCr28FeSiCe	–	–
2.4951	NiCr20Ti	–	2 HR 504	–	–

Terminology A–L

A

A-E	Wrench head for standard locknut
A-E AX	Wrench head for slip-off proof locknut
A-E M	Wrench head for Mini locknut
A-E MS	Wrench head for Mini Speed locknut
A-E MX	Wrench head for intRlox® locknut
A-E P	Wrench head with profile for hexagon locknut
A-FLS	Roller-wrench-head
ANSI	American national standards institute
APC	Clamping insert for manual powRgrip® clamping unit PGC
APG	Clamping insert for automatic powRgrip® clamping unit PGU
AT1	Taper angle tolerance – gauge quality
AT3	taper angle tolerance
ATL	Tangs for Morsetaper shanks DIN 228-C

B

BT	Steep taper Norm BT MAS 403
BT+	Steep taper Norm BT+ licensed by BIG Daishowa Seiki

C

C3 – C8	REGO-FIX CAPTO sizes
CAPTO	Interface standard Capto licensed by Sandvik Coromant
CAT	Steep taper norm CAT (ASME 5.50)
CC	Chip cover for reduction sleeves
CGA	Coolant thread adapter for cylindrical toolholders
CPS	Cleaning paper set for powRgrip® taper cleaner
CRYO	Cryogen coolant
CTPG	Collet tray for powRgrip® collets
CYD	Cylindrical shank double toolholder
CYDF	Cylindrical shank double toolholder with clamping flat
CYL	Cylindrical shank toolholder
CYLF	Cylindrical shank toolholder with clamping flat

D

DS	Sealing disk
DSR	Tray for Sealing disks

E

E	Wrench for standard locknut
E A	Wrench for locknut with external thread
E AX	Wrench for slip-off proof locknut
E M	Wrench for Mini locknut
E MS	Wrench for Mini Speed locknut
E MX	Wrench for intRlox® locknut
E P	Wrench with profile for hexagon locknut
EHS	Extraction tool for reduction sleeves
ER	ER standard collet runout ≤ 10 µm
ER	ER collet DIN 6499 (E collet REGO-FIX)
ER MS	ER locknut Mini Speed
ER NC	Cylindrical toolholder with shank NC lathe

ERA/Zero-Z	Toolholder with minimal gauge length and internal locknut
ERAX	Slip-off proof locknut with external thread
ERAXC	Slip-off proof locknut with external thread for sealing disks
ERB	Locknut with friction bearing
ERBC	Locknut with friction bearing for sealing disks
ERC	Locknut for sealing disks
ER-DM	ER collet metalically sealed
ER-GB	Tapping Collets with square without axial compensation
ERM	Locknut with Mini thread
ERMC	Locknut with Mini thread for sealing disks
ERMX	Slip-off proof Mini locknut intRlox®
ERMXC	Slip-off proof Mini locknut intRlox® for sealing disks
ER-UP	ER ultra precision collet runout ≤ 5 µm

F

FDS	Wrench for Universal Shellmill/Facemill Holders
FWR	Balancing ring

G

G-A	Grip bar
G-AS	Grip bar short
GSF	Tapping holder

H

H	Designed for FWR
HD	Heavy duty
Hi-Q	Clamping nut balanced and surface treated (impregnated)
HPC	High-performance-cutting
HS	Reduction sleeve
HSC	High-speed-cutting
HSK	Hollow taper shank
HSK-FP	Hollow taper shank form F with pin

I

IKZ	Coolant trough
INOX	Stainless steel
intRlox®	Slip-off proof nut and wrench
ISO 20 HAAS	Toolholders for HAAS Office Mill

K

KBF	Drill chuck
KFD	Universal Shellmill/Facemill Holders
KS	Coolant disk
KSR	Coolant tube

L

L	Clamping nut with left handed thread
---	--------------------------------------

Terminology M–Z

M

MA	Shell Mill Arbor
MB	Microbore collet
MBX	Microbore collet with clamping range – stainless
MFD	Micro friction dampening
MK	Morse Taper DIN 228
ML	Multi Line
MPH	Mini floating chuck
MPHC	Mini floating chuck for internal coolant supply
MQL	Minimum quantity lubrication
MR	micRun® collet runout $\leq 2\mu\text{m}$
MRC	micRun® locknut for sealing disks
MRM	micRun® Mini locknut
MRMC	micRun® Mini locknut for sealing disks
MWZ	Assembly tool for sealing disks DS/ER 11

N

NC	Cylindrical toolholder with shank NC lathe
NCT	No thread for coolant tube
NL	powRgrip® collets PG-L cannot be used
Nm	Newton meter

O

OM	Steep taper toolholders without drive key slots
----	---

P

PCM ET1	Tapping collet with axial compensation
PG	powRgrip®
PGC	Manual powRgrip® clamping unit
PG-CF	powRgrip® coolant flush collet for peripheral cooling
PG-L	powRgrip® collet for long tool shanks
PG-MB	powRgrip® microbore collet
PG-S	powRgrip® collet for short tool shanks
PG-SG	powRgrip® secuRgrip® collet for pull-out protection
PGST	powRgrip® short tail collet for PGST system
PG-T	powRgrip® collet for boring bars
PG-TAP	powRgrip® tapping collet
PG-TW	powRgrip® collet thin walled with limited life-time
PGU	Automatic powRgrip® clamping unit
PGU 9500 A	powRgrip® clamping unit USA (115 V)
PGU 9500 E	powRgrip® clamping unit Europe (230 V)
PGU 9500 J	powRgrip® clamping unit Japan (100 V)
PH	Floating chuck
PHC	Floating chuck for internal coolant supply
PHC-C	REGO-FIX CAPTO floating chuck for internal coolant supply

R

Ra	Unit for surface finishing
RBA	reCool® ball adapter
RCR	reCool® rotary
RCS	reCool® static
REGO-FIX	Swiss company for tool holding solutions

RHS	reCool® hose with protector spring
RRA	reCool® aluminium ring adapter
RVA	reCool® 90° elbow push-in fitting
RVG	reCool® straight push-in fitting

S

SG	secuRgrip® available for PG and ER
SGI	secuRgrip® threaded insert
SGN-PG	secuRgrip® safety nut
SH	Automotive Shank toolholders DIN 6327-C
SK	Steep taper
SKR	Key for coolant tube
SSM	Quick-change setting ring
SSY	Soft-Synchro tapping holder

T

TCD	Brush head for taper cleaning device
TCD-BU	Base unit taper cleaning device
TKCP	powRgrip® taper cleaner with cleaning paper
TSD	TORX Torque screwdriver

V

V-E AX	Slip-off proof extension
V-E MX	Slip-off proof extension intRlox®
VEW	Presetting tool for powRgrip® toolholders

W

WA	Tool adapter
WD	Endmill toolholder (Weldon)
WMH	Tool assembly indexing

X

X	Slip-off proof
XL	Extra long toolholder

Z

ZWT	Tray for ER collets (metric)
ZZT	Tray for ER collets (inch)

REGO-FIX AG is ISO certified:
ISO 9001 for quality management / since 1996
ISO 14001 for environmental management / since 2007
ISO 45001 for occupational health and safety / since 2019

This document should not be used or relied on for any purpose other than that intended by REGO-FIX AG.
No part of this document may be reproduced or transmitted in any other form without the express written permission of REGO-FIX AG.

The data given in this catalog are dependent on the conditions under which they are measured and are derived from tests carried out under defined lab conditions at REGO-FIX AG. The performance of these tools depends on the conditions under which they are used and may vary from case to case. The information given in this catalog is believed to be correct. REGO-FIX AG however assumes no responsibility or liability for any errors, inaccuracies or omissions that may appear in this catalog. Information in this catalog is subject to change without notice and should not be construed as a commitment by REGO-FIX AG or its subsidiaries. This is especially valid for adaptations to new or changed international standards or improvements to the products performance or production processes.

Softsynchro® is a registered trademark of EMUGE-Werk Richard Glimpel GmbH & Co. KG. Viton® is a brand of synthetic rubber and fluoropolymer elastomer of DuPont Performance Elastomers. CAPTO® is a registered trademark of AB Sandvik Coromant. BIG PLUS® is licensed by BIG Daishowa.

© Copyright REGO-FIX AG



REGO-FIX▲

